

Optical Readout and Control Systems for the CMS Tracker

Jan Troska, Giovanni Cervelli, Federico Faccio, Karl Gill, Robert Grabit, Anne Marie Sandvik, François Vasey, and Alessandro Zanet

Abstract-- The Compact Muon Solenoid (CMS) Experiment will be installed at the CERN Large Hadron Collider (LHC) in 2007. The readout system for the CMS Tracker consists of ~10 million individual detector channels that are time-multiplexed onto ~40000 uni-directional analogue (40MS/s) optical links for transmission between the detector and the ~65m distant counting room. The corresponding control system consists of ~2500 bi-directional digital (40Mb/s) optical links based upon the same components as far as possible. The on-detector elements (lasers and photodiodes) of both readout and control links will be distributed throughout the detector volume in close proximity to the silicon detector elements. For this reason, strict requirements are placed on minimal package size, mass, power dissipation, immunity to magnetic field and radiation hardness. It has been possible to meet the requirements with the extensive use of commercially available components with a minimum of customization.

The project has now entered its volume production phase after successful completion of technical feasibility. Components have been identified that meet both the stringent analogue performance targets and are sufficiently radiation-hard for use in the CMS Tracker, where lifetime radiation exposure is expected to reach $\sim 3.4 \times 10^{14} \text{cm}^2$ fluence and $\sim 150 \text{kGy}$ dose. Analogue and digital system performance, as well as the component radiation hardness and quality assurance procedures, are reviewed in this paper.

I. INTRODUCTION

The Compact Muon Solenoid (CMS) Experiment [1] is presently under construction for operation at the CERN Large Hadron Collider (LHC). The central Tracker of CMS is comprised of ~10million silicon microstrips arranged around the proton interaction point at the centre of CMS [2]. The level of radiation experienced by the Tracker system over the nominal ten-year lifetime is expected to reach $\sim 3.4 \times 10^{14} \text{cm}^2$ particle fluence and $\sim 150 \text{kGy}$ dose [2]. The Tracker system will operate at an ambient temperature of -10°C in a magnetic field of 4T. Data generated by the silicon detector modules must be sent to a remote counting room ~65m away, while timing, trigger and control (TTC) information must be passed in both directions between detector and counting room. Optical data transmission has

been chosen for both data readout and TTC signals because of its immunity to electromagnetic interference, potential for low power and low mass, and provision of galvanic isolation between on- and off-detector electronics [3].

The CMS Tracker Readout and Control System is shown in Fig. 1. Data from the Silicon Microstrips are processed by the APV front-end ASIC, which amplifies the signal, samples it at the 40MHz LHC bunch-crossing frequency and stores it in an analogue pipeline pending a trigger. Upon receipt of a Level 1 Trigger the data are time-multiplexed (256:1) and transmitted over an analogue optical link to the counting room, where the received data are digitised and formatted on the Front-End Driver (FED) VME board before being sent onto the higher-level Data Acquisition (DAQ) system. The system requirement is for an analogue data transmission system capable of pulse amplitude modulation at 40MS/s with 8-bit resolution and 1% non-linearity.

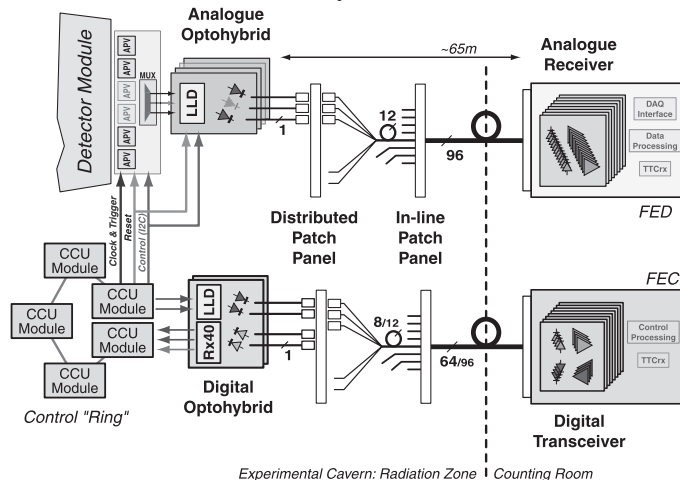

Fig. 1. Overview of the CMS Tracker Readout (top) and Control (bottom) Systems with the optical links carrying data from the experiment to the counting room.

The Tracker control system uses a token-ring-like architecture with a master control node (the Front-End Controller, FEC) located in the counting room and several Communication and Control Units (CCUs) located on the larger mechanical sub-structures of the Tracker. Clock and control data are transmitted optically from the FEC to the front-end, passed sequentially around the ring of CCU modules electrically, then re-transmitted back to the FEC via the digital optical link. The digital optical link therefore carries both 40MHz clock and 40Mb/s digital control data.

Manuscript received November 29, 2002.

J. Troska, G. Cervelli, F. Faccio, K. Gill, R. Grabit, A. M. Sandvik, and F. Vasey are with CERN, European Organization for Nuclear Research, CH-1211 Geneva 23, Switzerland (e-mail: jan.troska@cern.ch).

A Zanet was with CERN, European Organization for Nuclear Research, CH-1211 Geneva 23, Switzerland

Trigger information for the front-end is encoded onto the clock signal as missing clock pulses. A reset command is sent to the front-end as 10 clock-cycles of missing data, which are interpreted by the receiver ASIC that then generates an electrical reset signal for distribution to the detector modules. The electrical on-detector ring allows the number of optical control links to be reduced. Redundancy is provided through full duplication of the electrical and optical signal paths in the control system. The control link requires the Bit Error Rate (BER) to be below 10^{-12} and jitter lower than 0.5ns.

II. OPTICAL LINK SYSTEMS

The analogue optical readout system that will be implemented operates single-mode at 1310nm wavelength. The custom-designed laser driver ASIC (LLD) [4] directly modulates the edge-emitting laser diode drive current to achieve light amplitude modulation. Single fibres from the pigtailed lasers are connected at the periphery of the Tracker via small form-factor MU-type single-way connectors to a fan-in, which merges single fibres into a 12-fibre ribbon. There is a second break-point within the CMS Detector where the transition to a rugged multi-ribbon cable (8× 12-fibre ribbons/cable) is made via 12-channel MFS-type array connectors. In the counting room each ribbon connects directly to a 12-channel analogue optical receiver (ARx) module on the FED.

Digital control and timing information generated on the FEC is output by the transmitter half of a 4-channel digital transceiver (DTRx). After passing through an identical fibre system to the analogue link, the data are detected by pigtailed InGaAs photodiodes and recovered by a custom-designed digital receiver ASIC (Rx40) [5]. Data are returned to the FEC via the same transmitting components used in the analogue link after passing around the control ring. Data are received at the FEC by the receiver half of the DTRx.

All optical, optoelectronic and electronic components required for the analogue readout links have now been selected. Commercially available laser packages are too bulky for use inside the detector volume, so a semi-custom package has been designed by an industrial partner for the chosen off-the-shelf edge-emitting laser die and production is currently starting. The analogue off-detector receiver (ARx) is a modification of a commercial 12-channel digital module where the amplifier ASIC has been exchanged for a custom-designed analogue variant. Volume production of the ARx will start in Q2 2003. The LLD and Rx40 ASICs have been implemented in a commercial 0.25 μ m process using radiation tolerant layout techniques and the final production masks are available for production in 2003. Optical fibre, ribbon and connectors have all been selected and production is underway.

The commercial components specific to the digital link (photodiode and DTRx) are undergoing final specification and the commercial actions necessary for the final selection will

take place by Q2 2003. Further information regarding the optical link components and specifications is available [6].

III. ANALOGUE LINK PERFORMANCE

Analogue data produced by the silicon microstrip detector are time-multiplexed at a ratio of 256:1 with a sample-width of 25ns to yield a data-frame for transmission by the readout optical link (Fig. 2).

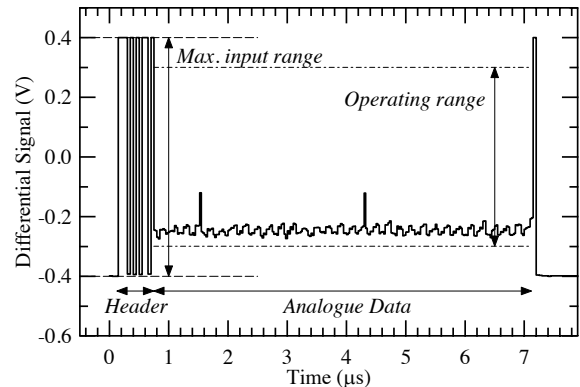

Fig. 2. Typical data-frame at the input to the readout link. The digital header covers the maximum link operating range (± 400 mV), while the operating range for the 256 analogue signals is ± 300 mV. The two peaks in the analogue data correspond to simulated particle signals.

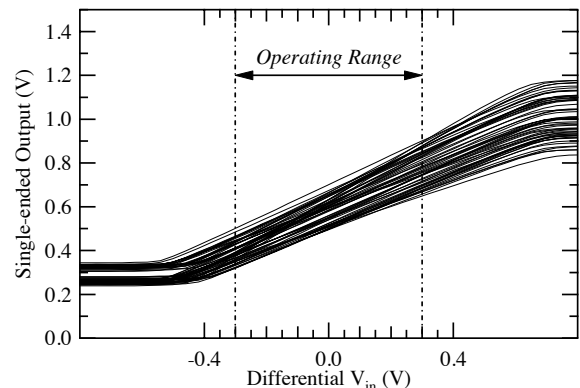

Fig. 3. Analogue transfer characteristics for 60 channels from five pre-production receiver ASICs. The readout link operating range of ± 300 mV is shown for reference.

To assess the performance of the readout link, a ramp is injected into the input and the output is read DC-coupled to yield the transfer characteristic and AC-coupled to yield the noise. Linearity is then extracted from the transfer characteristic by fitting a straight line over the ± 300 mV input range and plotting the residual referred to the input. The measured noise is also referred back to the link input for easier comparison with other noise sources in the full Tracker readout system. Fig. 3 shows typical analogue link transfer characteristics, in this case measured on five 12-channel pre-production receiver ASICs. Good channel-to-channel and module-to-module uniformity is achieved.

To aid the assessment of the performance of a measured component or full link, several figures of merit are calculated from the raw measurement data. These assess the link gain,

linearity and noise – the three most important specifications of the analogue readout system. Fig. 4 shows the linearity and noise figures of merit for the data presented in Fig. 3. The linear range, which measures the link input range for which the output non-linearity is better than 1% of the operating range, should be at least as large as the operating range (0.6V). In order to assess the noise, the measured noise is averaged over the operating range. This average should be compatible with the readout system resolution of 8bits over the operating range, which corresponds to 2.4mV Equivalent Input Noise (EIN) in the optical link.

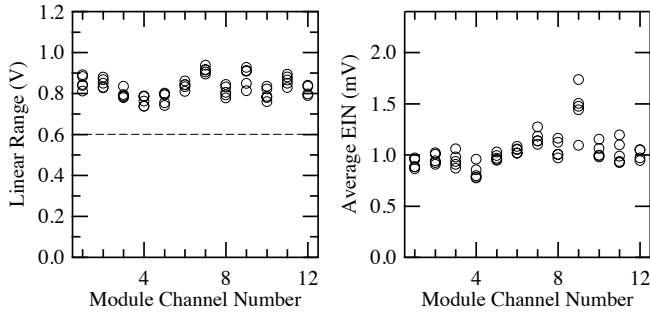

Fig. 4. Linear range and average Equivalent Input Noise (EIN) for pre-production receiver ASICs measured in-system.

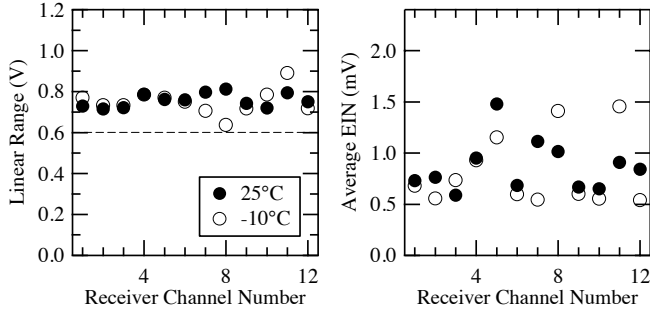

Fig. 5. Linear range and average Equivalent Input Noise (EIN) for the full optical link chain operating at room- and Tracker-nominal temperature.

Analogue link performance has also been demonstrated with final components operating as a full chain both in isolation and when incorporated into a full system with detector modules and off-detector digitisation. Fig. 5 shows the in-spec operation of 12 channels both at room temperature and the nominal Tracker operating temperature of -10°C in terms of the figures of merit described above. For this test a prototype analogue optohybrid was placed inside an environmental chamber while the ARx module was operated in a VME crate. These situations mimicked the final operation of the Tracker readout system with a full analogue optical link chain. Fig. 6 shows the output of a full Tracker readout system operating at room temperature. Full system testing has shown that the inclusion of the optical link has not increased the overall noise and has indeed improved the performance of the detector system by providing galvanic isolation and removing ground loops between front-end and back-end.

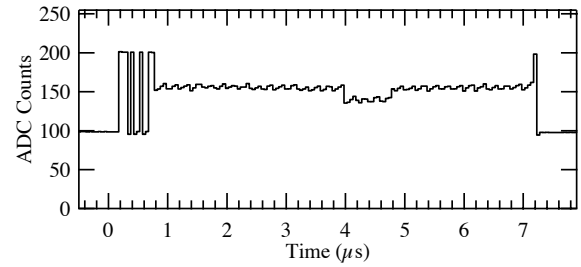

Fig. 6. Digitised data-frame from a single front-end amplifier (128 data values from one of the two multiplexed front-end ASICs) taken using a full Tracker readout system with detector module, optical link and prototype FED outputting 8bits. A negative-going calibration pulse can be seen at 4-5 μs .

IV. DIGITAL LINK PERFORMANCE

The digital control link based upon analogue link components has been evaluated against the system specifications in terms of detailed functionality. Fig. 7 shows the eye pattern obtained from a full system to be wide open, with the well defined crossing points indicating low jitter. A Bit Error Rate Tester (BERT) is used to characterise the detailed performance of the control link and assess the operating margins. By inserting additional attenuation between the front- and back-end components the BER can be measured as a function of optical power in the system. A typical such result is shown in Fig. 8. The operating margin is then given by comparing the typical operating range for the modulation signal with the saturation and sensitivity limits found from the measurement. The operating margin for the control link is in excess of 5dB, as shown in Fig.8.

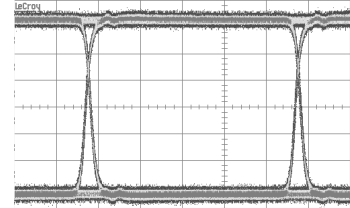

Fig. 7. Eye pattern of the LVDS output of the digital optohybrid. Horizontal scale is 5ns/div, Vertical scale is 100mV/div.

An issue with the commercial transceiver (DTRx) that we are targeting for use in the control link is one of operating speed. In line with most commercial components, the prototype transceivers are designed to operate at multi-Gb/s speeds – whereas the CMS Tracker control links transmit data at 40Mb/s and clock at 80Mb/s. In addition, the transmitter section of the DTRx must correctly transmit an absence of data over at least ten clock cycles to indicate to the front-end that a reset has been requested. Fig. 9 shows the correct recovery of a reset request by the digital optohybrid. This confirms the ability of the tested transceiver type to operate in the digital control system.

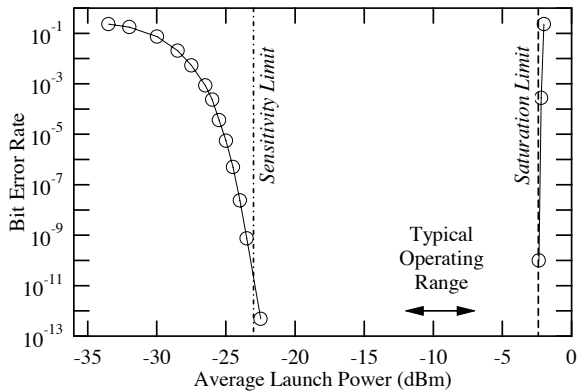

Fig. 8. Bit Error Rate plot for the front-end to back-end branch of the control link showing the operating range lying between sensitivity and saturation limits with good margin.

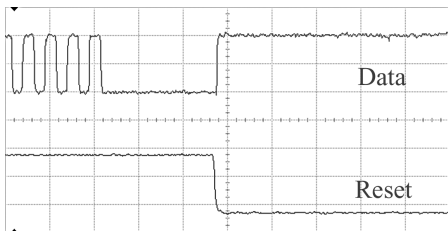

Fig. 9. Reset generation at the digital optohybrid. The transceiver has successfully sent the missing data pulses which have been decoded by the Rx40 receiver ASIC.

The prototype digital control link has been successfully incorporated in a full control ring with multiple CCUs and a prototype FEC. Similar systems are in use at various institutes within the CMS Tracker collaboration that are carrying out complete detector system tests.

V. RADIATION HARDNESS

Extensive studies have been carried out over a five-year period to measure the radiation response of all components (laser diodes, photodiodes, optical fibre/cable and connectors) that will be used in the radiation zone [7-11]. As an example, the effect of neutron irradiation on the laser transmitters used in both readout and control links is shown in Fig. 10. Particle irradiation of laser diodes causes an increase in laser threshold current and a decrease in light output efficiency, which have been found to anneal after irradiation as a function of forward current and temperature [8].

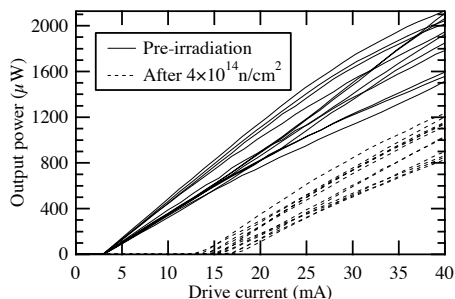

Fig. 10. Typical effect of neutron irradiation on the L-I curve of the edge-emitting lasers used in the CMS Tracker optical readout and control links.

Such studies have not only proven that the components are sufficiently radiation resistant to be used, but also allowed us to parameterise their response to allow prediction of the foreseen degradation due to radiation exposure within CMS (Fig. 11) [10]. This is significant since most radiation testing is carried out over timescales that are short (hours, days) by comparison to the radiation exposure that will occur over the nominal ten-year lifetime of the installed system. During the longer exposure at lower fluxes and dose rates more annealing (relative to short exposures) will occur, which our model is able to take into account. The LLD ASIC has been designed to have a programmable bias point in the range 0-45mA to compensate for the radiation-induced threshold increase.

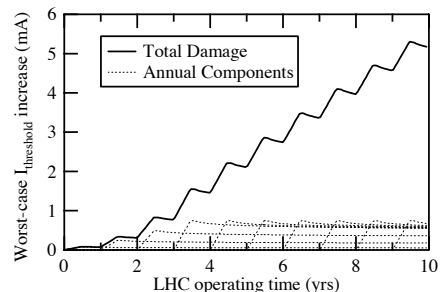

Fig. 11. Worst-case prediction of laser threshold change due to the radiation field within the CMS Tracker.

The Commercial Off-The-Shelf (COTS) single-mode fibre that will be deployed in our optical link systems has been found to be sufficiently radiation hard for our application [7]. Worst-case radiation-induced loss will be limited to 0.1dB over the few metres that will be exposed at CMS-like total dose and dose-rate. This loss equivalent to the re-connection uncertainty of one of the connection points in the optical link. Photodiodes for the control links show an increase in leakage current and a decrease in responsivity of up to 20% in the worst case [11]. The Rx40 ASIC is designed to sink the additional leakage current without affecting the sensitivity and a 20% (1dB) drop in signal amplitude does not significantly affect the operating margin of the control link.

The Single-Event Upset (SEU) behaviour of the Rx40 coupled to a prototype photodiode has been measured [12]. The sensitivity of the Rx40 ASIC (coupled to a prototype photodiode) has been limited by design to -20dBm to provide a threshold for the reset detection. This limit additionally guarantees that at the minimum optical power level of -20dBm the BER remains below 10^{-10} in the CMS Tracker particle field. At the typical in-system optical power level of -10dBm, a BER below 10^{-12} is predicted for operation under the Tracker particle flux of $10^6 \text{ cm}^{-2} \text{ s}^{-1}$, indicating the digital control link to be SEU tolerant to the required level.

VI. QUALITY ASSURANCE

Volume production of both analogue and digital links for the CMS Tracker brings new problems for quality assurance in a particle physics data transmission system. The stages of quality assurance activities for the project are shown in Fig.

12. By using COTS or COTS-based components purchased from industrial manufacturers we are able to benefit to a large extent from the routine quality testing carried out by the manufacturers. We can thus be confident that only known-good components are integrated into the optical links.

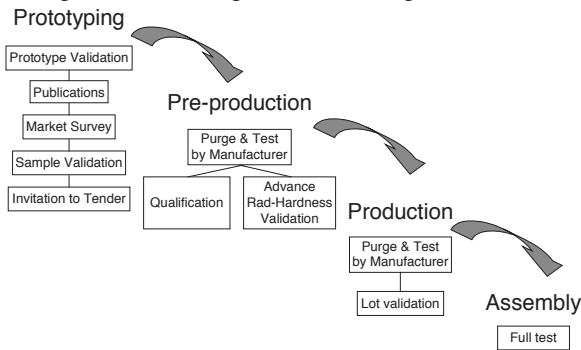

Fig. 12. Stages of QA activities from Prototyping to Assembly of the optical link systems within the CMS Tracker.

However, optical component vendors are in general unfamiliar with the use of their components in radiation environments and as such do not guarantee their products' radiation resistance. We have therefore put in place the Advance Validation Test (AVT) procedure shown in Fig. 13 to ensure that the final products used within CMS will be sufficiently radiation hard. The AVT concept has evolved from our extensive radiation-testing programme, which has given us evidence that components built from the same raw or base material are equally radiation resistant. This allows us to sample a laser diode wafer or optical fibre pre-form and on the basis of a single set of radiation tests to qualify all of the laser diodes from a particular wafer or all fibre from a particular pre-form for use in the CMS Tracker environment. We are thus able to extend the conventional idea of batch-level testing to radiation hardness assurance.

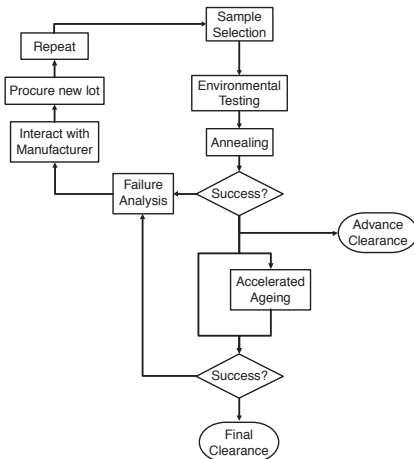

Fig. 13. Advance Validation Procedure. Environmental testing is radiation testing at gamma and neutron sources.

VII. CONCLUSION

The optical link concepts for both the analogue readout and digital control of the CMS Tracker have been reviewed. The performance of both optical link systems has been presented,

based upon the final prototypes received from the chosen manufacturers before the formal pre-production starts. The specified performance has been achieved for the two systems and we have good margins in both cases. System-level testing carried out within the CMS Tracker Collaboration has reinforced the standalone link testing.

The project is now entering the volume production phase with the first pre-production batches of active and passive components being qualified at CERN. Once production starts the test equipment and procedures are in place to accept each production lot upon receipt. Production of all optical link components will be complete by Q4 2004. This will allow the timely installation of the Tracker system inside the CMS detector, foreseen for 2006.

VIII. ACKNOWLEDGMENT

We acknowledge technical assistance of Christophe Sigaud and the CMS Tracker beam- and system-test teams for help in successfully integrating the optical links into their respective systems.

IX. REFERENCES

- [1] The Compact Muon Solenoid Technical Proposal, CERN/LHCC 94-38, Dec. 1994.
- [2] CMS Tracker Project Technical Design Report, CERN/LHCC 98-6, Apr. 1998, and Addendum, CERN/LHCC 2000-016, Feb. 2000.
- [3] F. Vasey, V. Arbet-Engels, J. Batten, G. Cervelli, K. Gill, R. Grabit, C. Mommaert, G. Stefanini, and J. Troska, "Development of radiation-hard optical links for the CMS tracker at CERN", *IEEE Trans. Nucl. Sci.*, vol. 45, no. 3, pp. 331-337, Jun. 1998.
- [4] G. Cervelli, A. Marchioro, P. Moreira, and F. Vasey, "A radiation tolerant laser driver array for optical transmission in the LHC experiments", *Proc. 7th Workshop on Electronics for LHC Experiments*, CERN/LHCC/2001-034, pp.155-159, Oct. 2001.
- [5] F. Faccio, P. Moreira, and A. Marchioro, "An 80Mbit/s radiation tolerant Optical Receiver for the CMS digital optical link", *Proc. SPIE*, vol. 4134, pp. 185-193, Oct. 2000.
- [6] "Optical Links for CMS", Available: <http://cern.ch/cms-opto>
- [7] J. Troska, J. Batten, K. Gill, and F.Vasey, "Radiation effects in commercial off-the-shelf single-mode optical fibers", *Proc. SPIE*, vol. 3440, pp. 112-119, Oct. 1998.
- [8] K. Gill, G. Cervelli, R. Grabit F. Jensen, and F. Vasey, "Radiation damage and annealing in 1310-nm InGaAsP/InP lasers for the CMS tracker", *Proc. SPIE*, vol. 4134, pp. 176-184, Oct. 2000.
- [9] K. Gill, C. Azevedo, J. Batten, G. Cervelli, R. Grabit F. Jensen, J. Troska, and F. Vasey, "Ageing tests of radiation damaged lasers and photodiodes for the CMS experiment at CERN", *IEEE Trans. Nucl. Sci.*, vol. 47, no. 3, pp. 667-674, Jun. 2000.
- [10] K. Gill, R. Grabit, J. Troska, and F. Vasey., "Combined radiation damage, annealing and ageing studies of InGaAsP/InP 1310nm lasers for the CMS Tracker optical links", *Proc. SPIE*, vol. 4823, in print.
- [11] K. Gill, C. Aguilar, V. Arbet-Engels, C. Azevedo, J. Batten, G. Cervelli, R. Grabit, F. Jensen, C. Mommaert, J. Troska, and F. Vasey, "Comparative Study of Radiation Hardness of Optoelectronic Components for the CMS Tracker Optical Links", *Proc. 4th Workshop on Electronics for LHC Experiments*, CERN/LHCC/1998-036, pp. 96-99, Sep. 1998.
- [12] F. Faccio, G. Berger, K. Gill, M. Huhtinen, A. Marchioro, P. Moreira, F. Vasey, "Single event upset tests of an 80Mbit/s optical receiver", *IEEE Trans. Nucl. Sci.*, vol. 48, no. 5, pp. 1700-1707, Oct. 2001.