

DO NOT SCALE FROM THIS PRINT

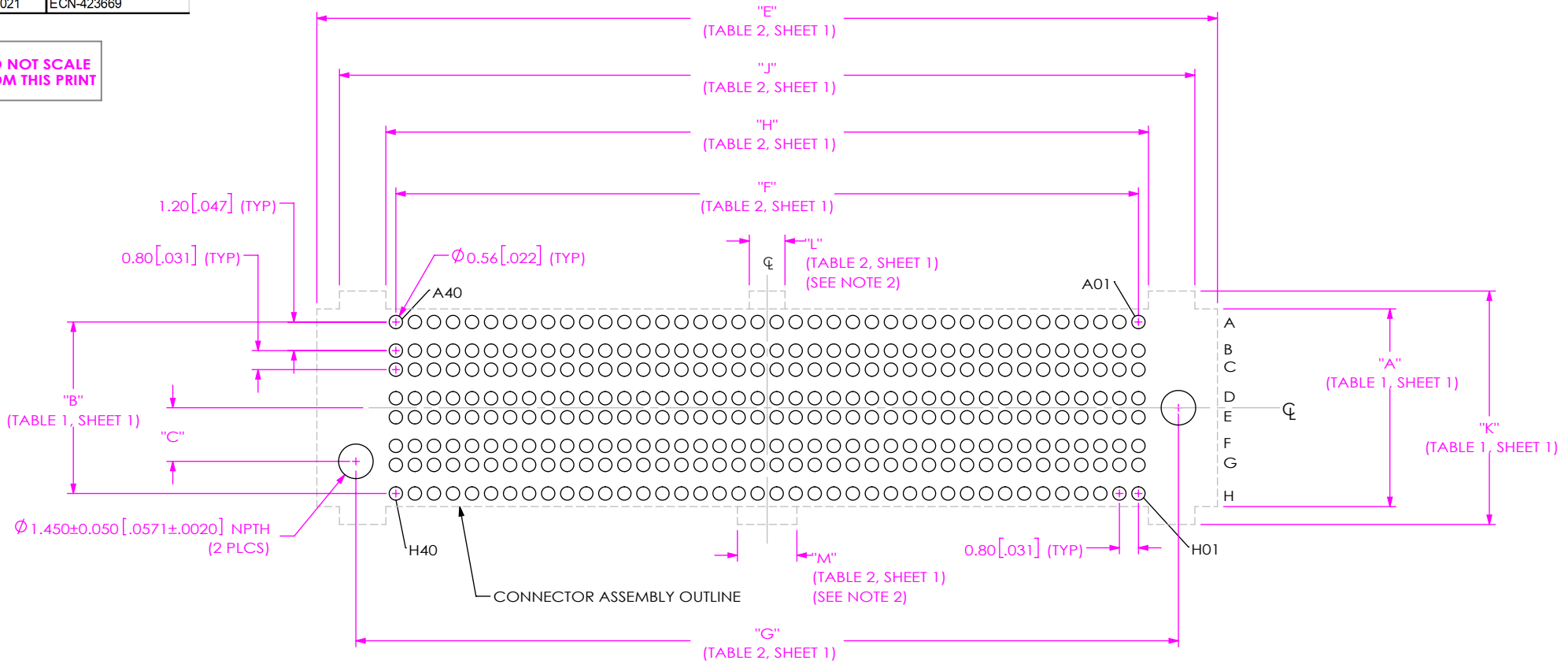

FIG 1  
SEAM8-XX-SXX.X-XXX-XX-1-XX-X-XX & SEAM8-XX-SXX.X-XXX-XX-3-XX-X-XX  
FOOTPRINTS SHOWN

TABLE 1

-No. OF ROWS	"A"	"B"	"C"	"K"
-04	4.30 [0.169]	3.20 [0.126]	1.25 [0.049]	5.80 [0.228]
-06	6.30 [0.248]	5.20 [0.205]	2.25 [0.089]	7.80 [0.307]
-08 (SEE NOTE 3)	8.30 [0.327]	7.20 [0.283]	2.25 [0.089]	9.80 [0.386]
-10 (SEE NOTE 3)	10.30 [0.406]	9.20 [0.362]	2.25 [0.089]	11.80 [0.465]

TABLE 2

No. OF POS. PER ROW	"E"	"F"	"G"	"H"	"J"	"L"	"M"	"N"	"P"
-10	13.84 [0.545]	7.20 [0.283]	10.56 [0.416]	8.04 [0.317]	11.94 [0.470]	N/A	N/A	17.70 [0.697]	21.34 [0.840]
-20	21.84 [0.860]	15.20 [0.598]	18.56 [0.731]	16.04 [0.631]	19.94 [0.785]	N/A	N/A	25.70 [1.012]	29.34 [1.155]
-30	29.84 [1.175]	23.20 [0.913]	26.56 [1.046]	24.04 [0.946]	27.94 [1.100]	N/A	N/A	33.70 [1.327]	37.34 [1.470]
-40	37.84 [1.490]	31.20 [1.228]	34.56 [1.361]	32.04 [1.261]	35.94 [1.415]	1.50 [0.059]	2.50 [0.098]	41.70 [1.642]	45.34 [1.785]
-50	45.84 [1.805]	39.20 [1.543]	42.56 [1.676]	40.04 [1.576]	43.94 [1.730]	1.50 [0.059]	2.50 [0.098]	49.70 [1.957]	53.34 [2.100]

NOTES:

1. ALL DIMENSIONS ARE SYMMETRIC ABOUT THE CENTERLINE.
2. CENTER MACHINE LUGS ONLY ON -S02.0 LEADSTYLE, -40 & -50 POSTIONS.
3. -08 & -10 ROW ARE RELEASED FOR NITROGEN ENVIRONMENT PROCESSING ONLY. NOT RECOMMENDED FOR AIR ONLY PROCESSING.
4. NOTE DELETED.

PROPRIETARY NOTE

THIS DOCUMENT CONTAINS CONFIDENTIAL AND PROPRIETARY INFORMATION AND ALL DESIGN, MANUFACTURING, REPRODUCTION, USE, PATENT RIGHTS AND SALES RIGHTS ARE EXPRESSLY RESERVED BY SAMTEC, INC. THIS DOCUMENT SHALL NOT BE DISCLOSED, IN WHOLE OR PART, TO ANY UNAUTHORIZED PERSON OR ENTITY NOR REPRODUCED, TRANSFERRED OR INCORPORATED IN ANY OTHER PROJECT IN ANY MANNER WITHOUT THE EXPRESS WRITTEN CONSENT OF SAMTEC, INC.



520 PARK EAST BLVD, NEW ALBANY, IN 47150  
PHONE: 812-944-6733 FAX: 812-948-5047  
e-Mail info@SAMTEC.com code 55322

NOTE:  
STENCIL TO BE 0.127 [.0050] THICK.

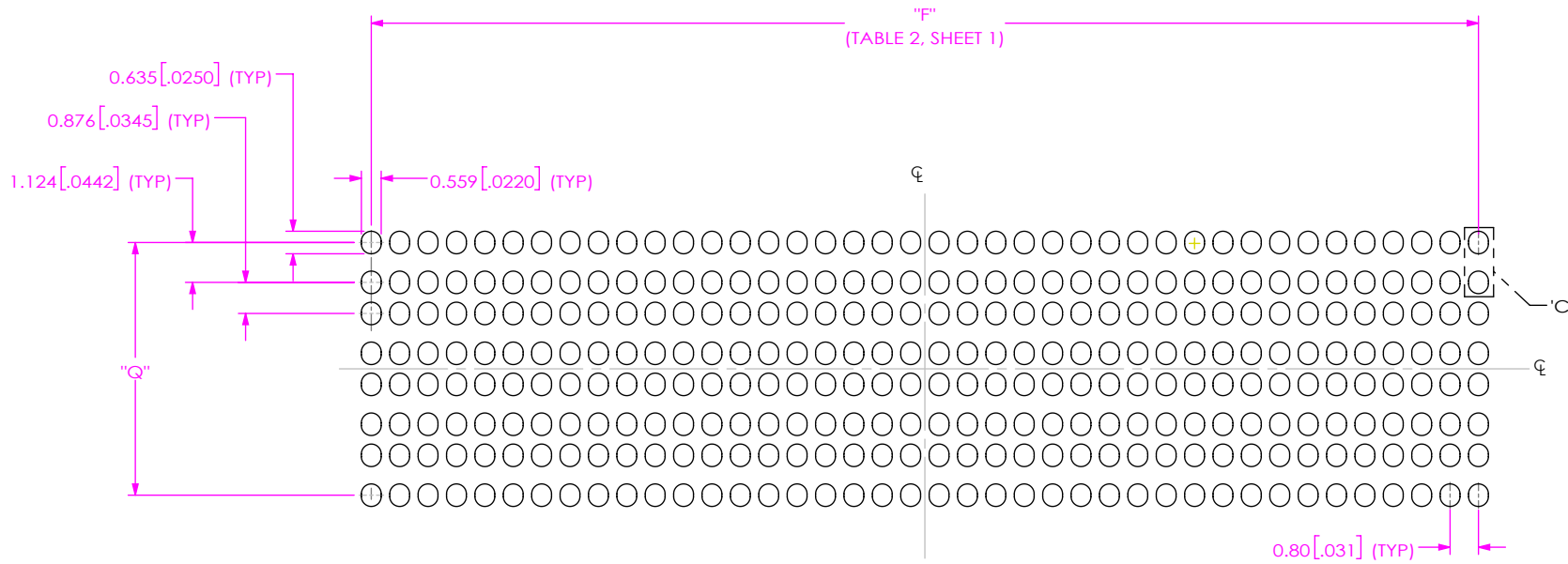

FIG 2  
SEAM8-XX-SXX.X-XXX-XX-1-XX-X-XX & SEAM8-XX-SXX.X-XXX-XX-3-XX-X-XX  
STENCIL SHOWN  
ALL DIMENSIONS ARE SYMMETRIC ABOUT THE CENTERLINE.

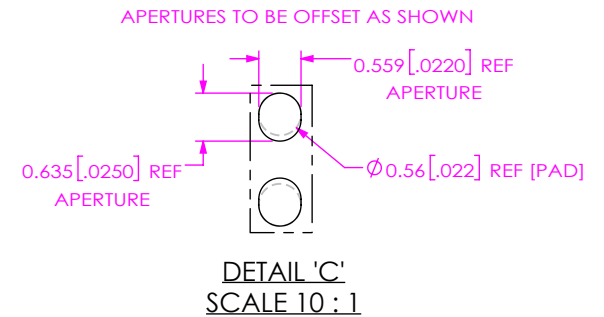

TABLE 3 (TYPE 1 & 3 SOLDER)	
No. OF ROWS	"Q"
-04	3.124 [0.1230]
-06	5.124 [0.2017]
-08 (SEE NOTE 3)	7.124 [0.2805]
-10 (SEE NOTE 3)	9.124 [0.3592]

**PROPRIETARY NOTE**  
THIS DOCUMENT CONTAINS CONFIDENTIAL AND PROPRIETARY INFORMATION AND ALL DESIGN, MANUFACTURING, REPRODUCTION, USE, PATENT RIGHTS AND SALES RIGHTS ARE EXPRESSLY RESERVED BY SAMTEC, INC. THIS DOCUMENT SHALL NOT BE DISCLOSED, IN WHOLE OR PART, TO ANY UNAUTHORIZED PERSON OR ENTITY NOR REPRODUCED, TRANSFERRED OR INCORPORATED IN ANY OTHER PROJECT IN ANY MANNER WITHOUT THE EXPRESS WRITTEN CONSENT OF SAMTEC, INC.



520 PARK EAST BLVD, NEW ALBANY, IN 47150  
PHONE: 812-944-6733 FAX: 812-948-5047  
e-Mail info@SAMTEC.com code 55322

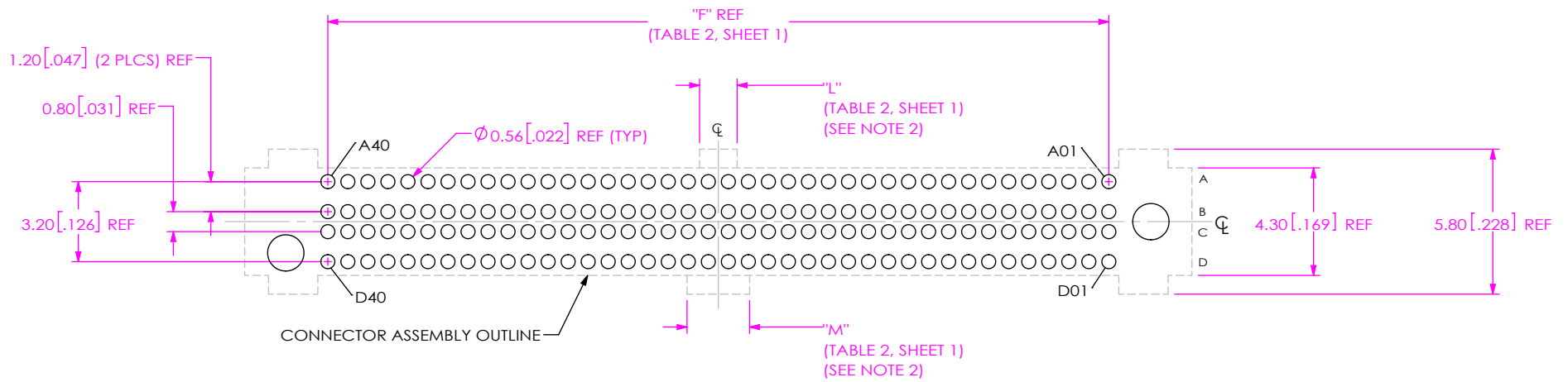

FIG 3  
SEAM8-40-SXX.X-XXX-04-1-XX-X-XX & SEAM8-40-SXX.X-XXX-04-3-XX-X-XX  
FOOTPRINTS SHOWN

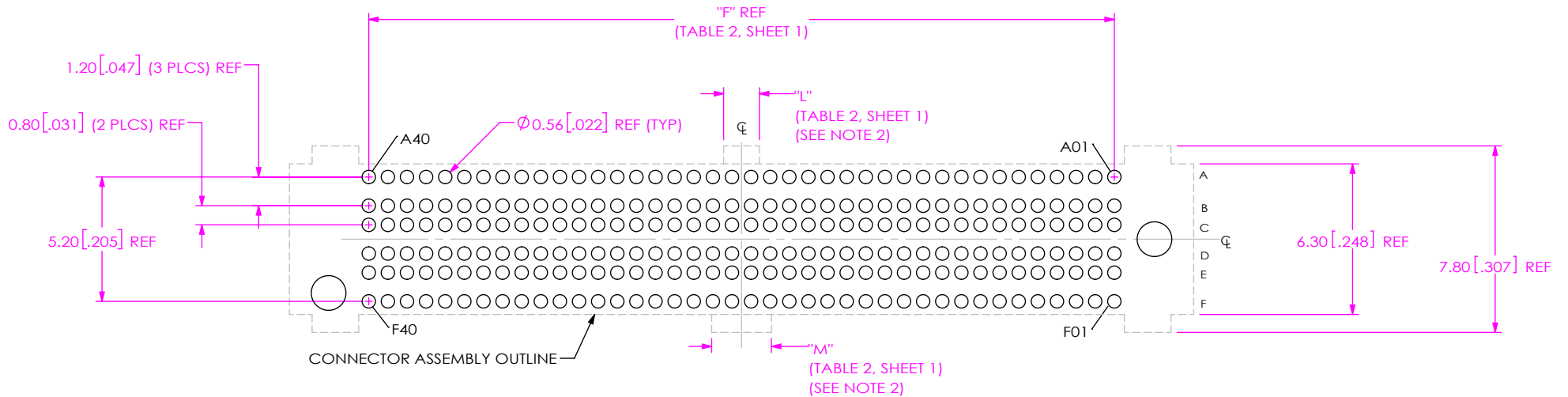

FIG 4  
SEAM8-40-SXX.X-XXX-06-1-XX-X-XX & SEAM8-40-SXX.X-XXX-06-3-XX-X-XX  
FOOTPRINTS SHOWN

**PROPRIETARY NOTE**  
THIS DOCUMENT CONTAINS CONFIDENTIAL AND PROPRIETARY INFORMATION AND ALL DESIGN, MANUFACTURING, REPRODUCTION, USE, PATENT RIGHTS AND SALES RIGHTS ARE EXPRESSLY RESERVED BY SAMTEC, INC. THIS DOCUMENT SHALL NOT BE DISCLOSED, IN WHOLE OR PART, TO ANY UNAUTHORIZED PERSON OR ENTITY NOR REPRODUCED, TRANSFERRED OR INCORPORATED IN ANY OTHER PROJECT IN ANY MANNER WITHOUT THE EXPRESS WRITTEN CONSENT OF SAMTEC, INC.



520 PARK EAST BLVD, NEW ALBANY, IN 47150  
PHONE: 812-944-6733 FAX: 812-948-5047  
e-Mail info@SAMTEC.com code 55322

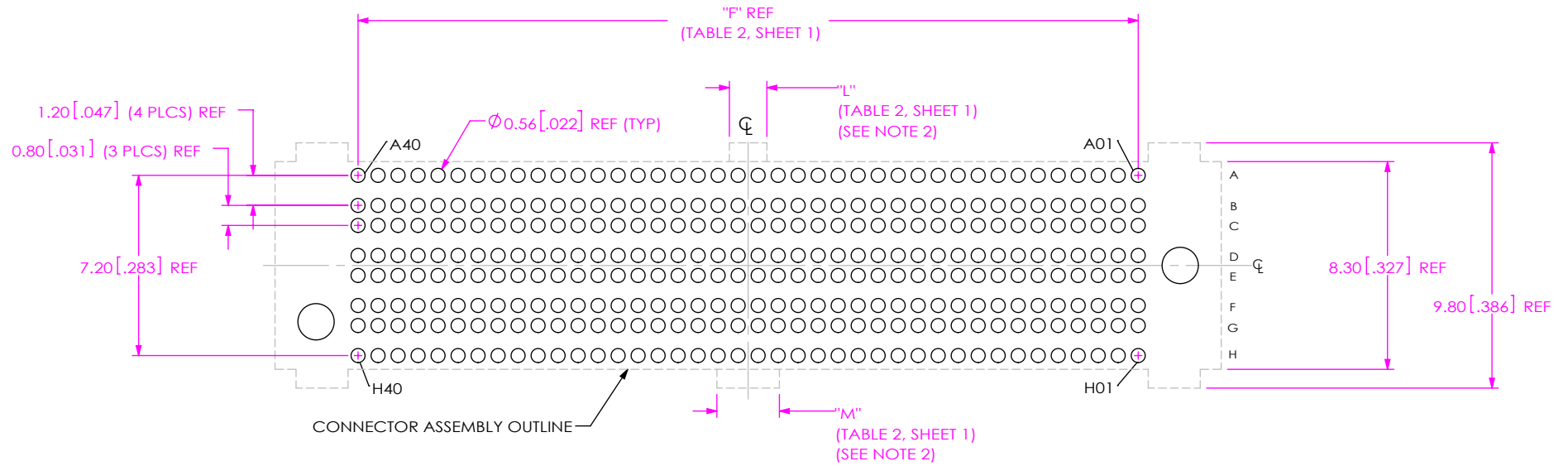

FIG 5  
SEAM8-40-SXX.X-XXX-08-1-XX-X-XX & SEAM8-40-SXX.X-XXX-08-3-XX-X-XX  
FOOTPRINT SHOWN

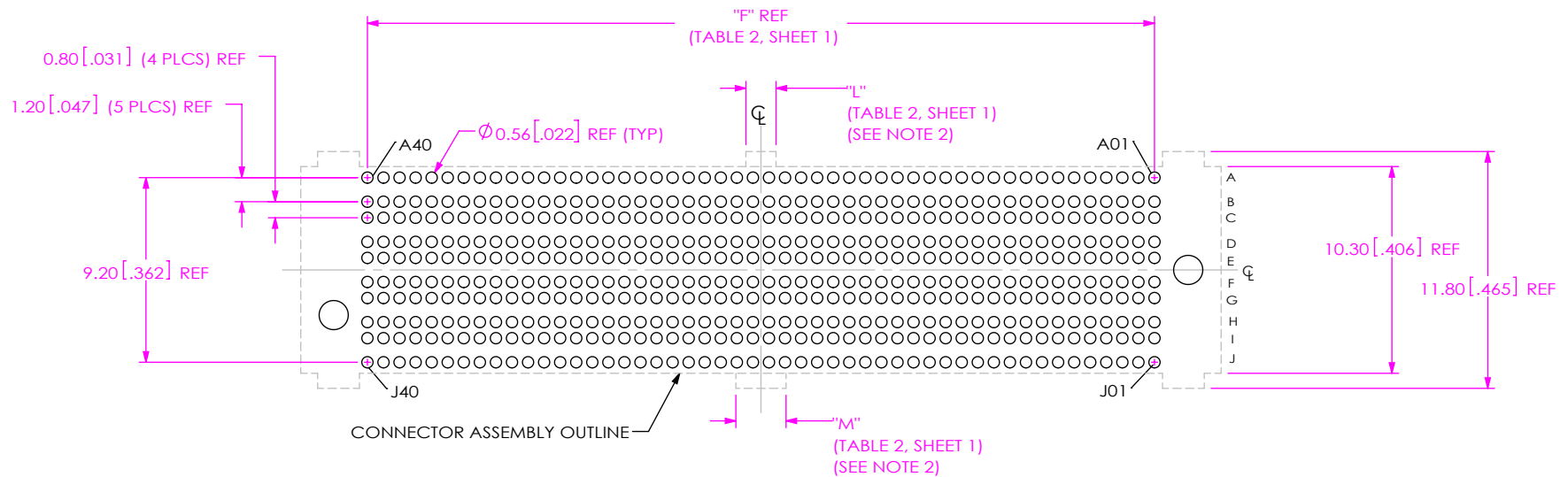
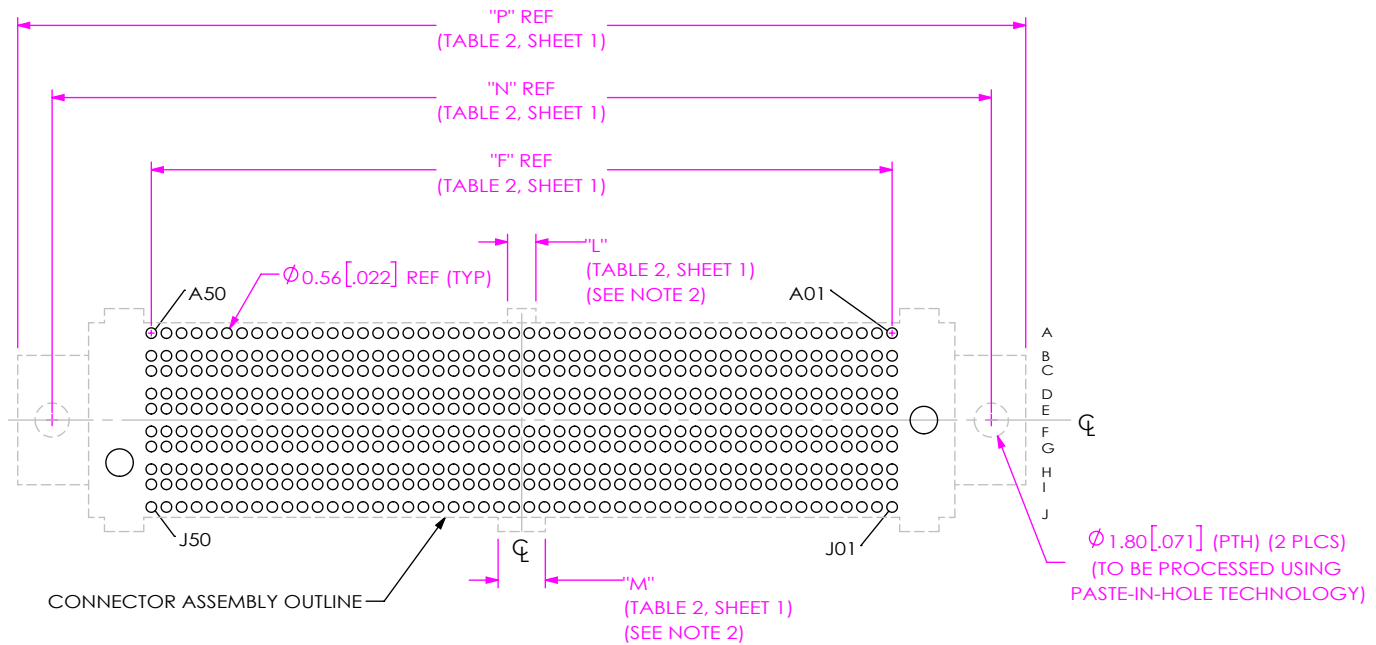

FIG 6  
SEAM8-40-SXX.X-XXX-10-1-XX-X-XX & SEAM8-40-SXX.X-XXX-10-3-XX-X-XX  
FOOTPRINT SHOWN

**PROPRIETARY NOTE**  
THIS DOCUMENT CONTAINS CONFIDENTIAL AND PROPRIETARY INFORMATION AND ALL DESIGN, MANUFACTURING, REPRODUCTION, USE, PATENT RIGHTS AND SALES RIGHTS ARE EXPRESSLY RESERVED BY SAMTEC, INC. THIS DOCUMENT SHALL NOT BE DISCLOSED, IN WHOLE OR PART, TO ANY UNAUTHORIZED PERSON OR ENTITY NOR REPRODUCED, TRANSFERRED OR INCORPORATED IN ANY OTHER PROJECT IN ANY MANNER WITHOUT THE EXPRESS WRITTEN CONSENT OF SAMTEC, INC.



520 PARK EAST BLVD, NEW ALBANY, IN 47150  
PHONE: 812-944-6733 FAX: 812-948-5047  
e-Mail info@SAMTEC.com code 55322



**FIG 7**  
 (GUIDE POST OPTION)  
 SEAM8-50-SXX.X-XXX-10-1-GP-X-XX & SEAM8-50-SXX.X-XXX-10-3-GP-X-XX  
 FOOTPRINTS SHOWN  
 (SAME AS FIGS 9, 11, 12, 13 & 14, EXCEPT AS SHOWN)

**PROPRIETARY NOTE**  
 THIS DOCUMENT CONTAINS CONFIDENTIAL AND PROPRIETARY INFORMATION AND ALL DESIGN, MANUFACTURING, REPRODUCTION, USE, PATENT RIGHTS AND SALES RIGHTS ARE EXPRESSLY RESERVED BY SAMTEC, INC. THIS DOCUMENT SHALL NOT BE DISCLOSED, IN WHOLE OR PART, TO ANY UNAUTHORIZED PERSON OR ENTITY NOR REPRODUCED, TRANSFERRED OR INCORPORATED IN ANY OTHER PROJECT IN ANY MANNER WITHOUT THE EXPRESS WRITTEN CONSENT OF SAMTEC, INC.

**samtec**  
 520 PARK EAST BLVD, NEW ALBANY, IN 47150  
 PHONE: 812-944-6733 FAX: 812-948-5047  
 e-Mail info@SAMTEC.com code 55322

NOTE:  
STENCIL TO BE 0.127 [.0050] THICK.



**FIG 8**  
(GUIDE POST OPTION)  
SEAM8-50-SXX.X-XXX-10-1-GP-X-XX & SEAM8-50-SXX.X-XXX-10-3-GP-X-XX  
STENCILS SHOWN  
(SAME AS FIG 10, EXCEPT AS SHOWN)  
ALL DIMENSIONS ARE SYMMETRIC ABOUT THE CENTERLINE.

**PROPRIETARY NOTE**  
THIS DOCUMENT CONTAINS CONFIDENTIAL AND PROPRIETARY INFORMATION AND ALL DESIGN, MANUFACTURING, REPRODUCTION, USE, PATENT RIGHTS AND SALES RIGHTS ARE EXPRESSLY RESERVED BY SAMTEC, INC. THIS DOCUMENT SHALL NOT BE DISCLOSED, IN WHOLE OR PART, TO ANY UNAUTHORIZED PERSON OR ENTITY NOR REPRODUCED, TRANSFERRED OR INCORPORATED IN ANY OTHER PROJECT IN ANY MANNER WITHOUT THE EXPRESS WRITTEN CONSENT OF SAMTEC, INC.

**samtec**  
520 PARK EAST BLVD, NEW ALBANY, IN 47150  
PHONE: 812-944-6733 FAX: 812-948-5047  
e-Mail info@SAMTEC.com code 55322

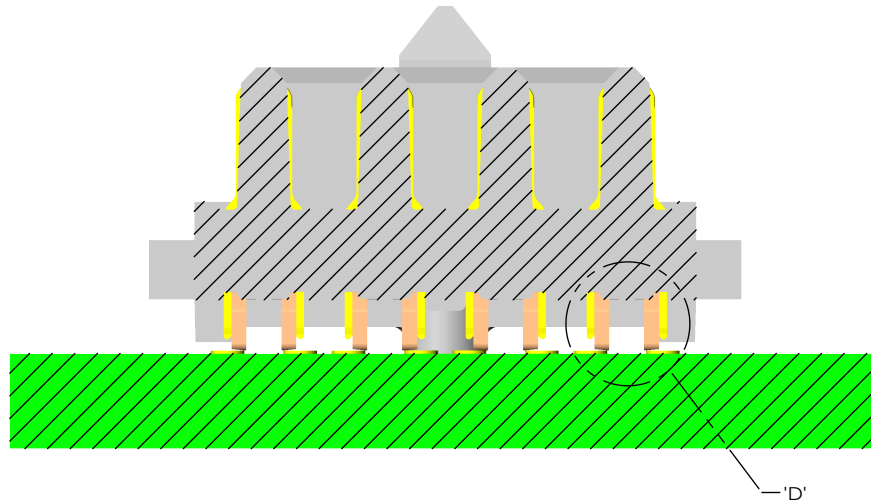

BEFORE SOLDER VIEW  
 SEAM8-XX-SXX.X-XXX-XX-1-XX-X-XX  
 & SEAM8-XX-SXX.X-XXX-XX-3-XX-X-XX ASSY SHOWN

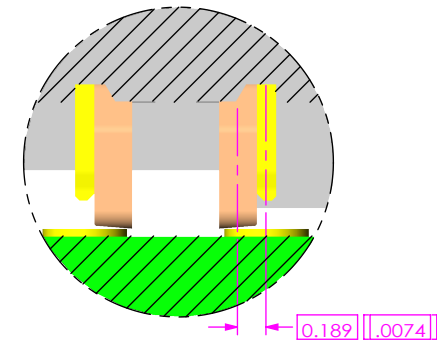

DETAIL 'D'  
 SCALE 20 : 1

**PROPRIETARY NOTE**  
 THIS DOCUMENT CONTAINS CONFIDENTIAL AND PROPRIETARY INFORMATION AND ALL DESIGN, MANUFACTURING, REPRODUCTION, USE, PATENT RIGHTS AND SALES RIGHTS ARE EXPRESSLY RESERVED BY SAMTEC, INC. THIS DOCUMENT SHALL NOT BE DISCLOSED, IN WHOLE OR PART, TO ANY UNAUTHORIZED PERSON OR ENTITY NOR REPRODUCED, TRANSFERRED OR INCORPORATED IN ANY OTHER PROJECT IN ANY MANNER WITHOUT THE EXPRESS WRITTEN CONSENT OF SAMTEC, INC.



520 PARK EAST BLVD, NEW ALBANY, IN 47150  
 PHONE: 812-944-6733 FAX: 812-948-5047  
 e-Mail info@SAMTEC.com code 55322

DESIGNED & DIMENSIONED  
IN MILLIMETERS [INCHES]

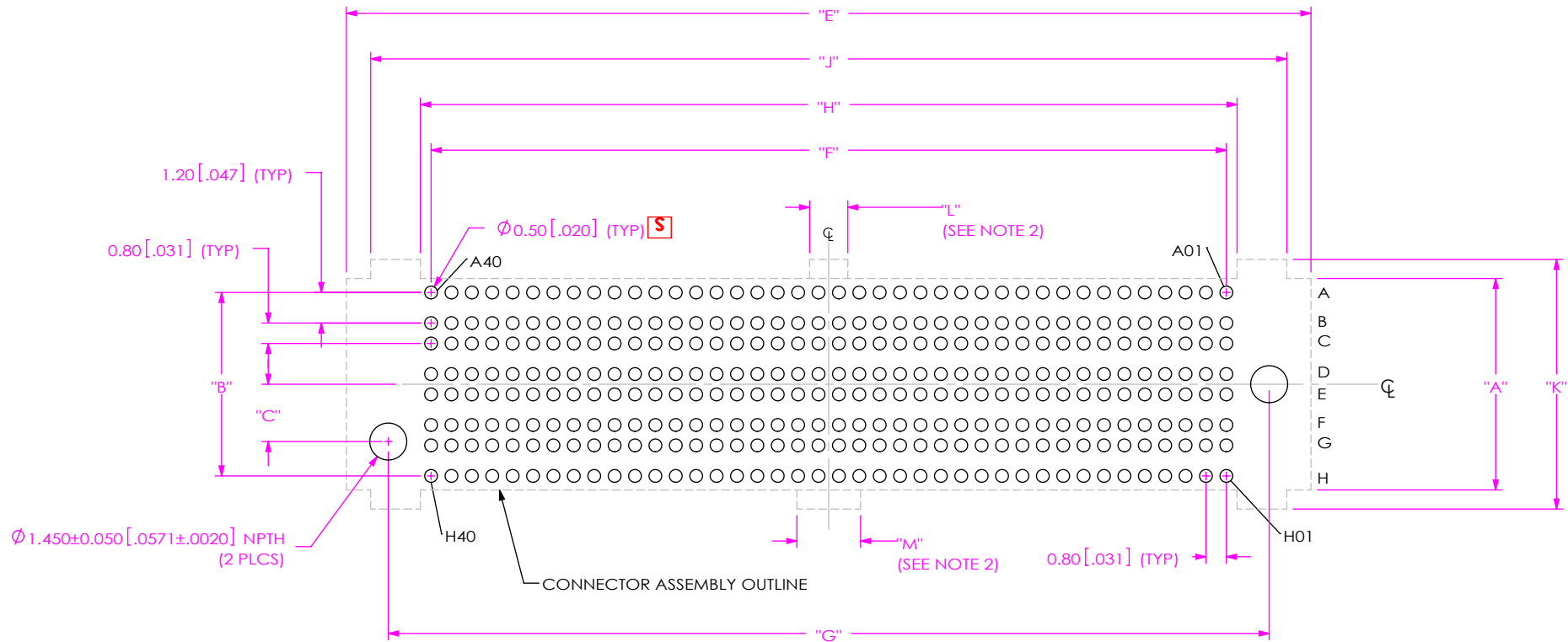

FIG 9  
SEAM8-XX-SXX.X-XXX-XX-2-XX-X-XX FOOTPRINT SHOWN

**PROPRIETARY NOTE**  
THIS DOCUMENT CONTAINS CONFIDENTIAL AND PROPRIETARY INFORMATION AND ALL DESIGN, MANUFACTURING, REPRODUCTION, USE, PATENT RIGHTS AND SALES RIGHTS ARE EXPRESSLY RESERVED BY SAMTEC, INC. THIS DOCUMENT SHALL NOT BE DISCLOSED, IN WHOLE OR PART, TO ANY UNAUTHORIZED PERSON OR ENTITY NOR REPRODUCED, TRANSFERRED OR INCORPORATED IN ANY OTHER PROJECT IN ANY MANNER WITHOUT THE EXPRESS WRITTEN CONSENT OF SAMTEC, INC.



520 PARK EAST BLVD. NEW ALBANY, IN 47150  
PHONE: 812-944-6733 FAX: 812-948-5047  
e-Mail info@SAMTEC.com code 55322



NOTE:  
STENCIL TO BE 0.127 [0.0050] THICK.

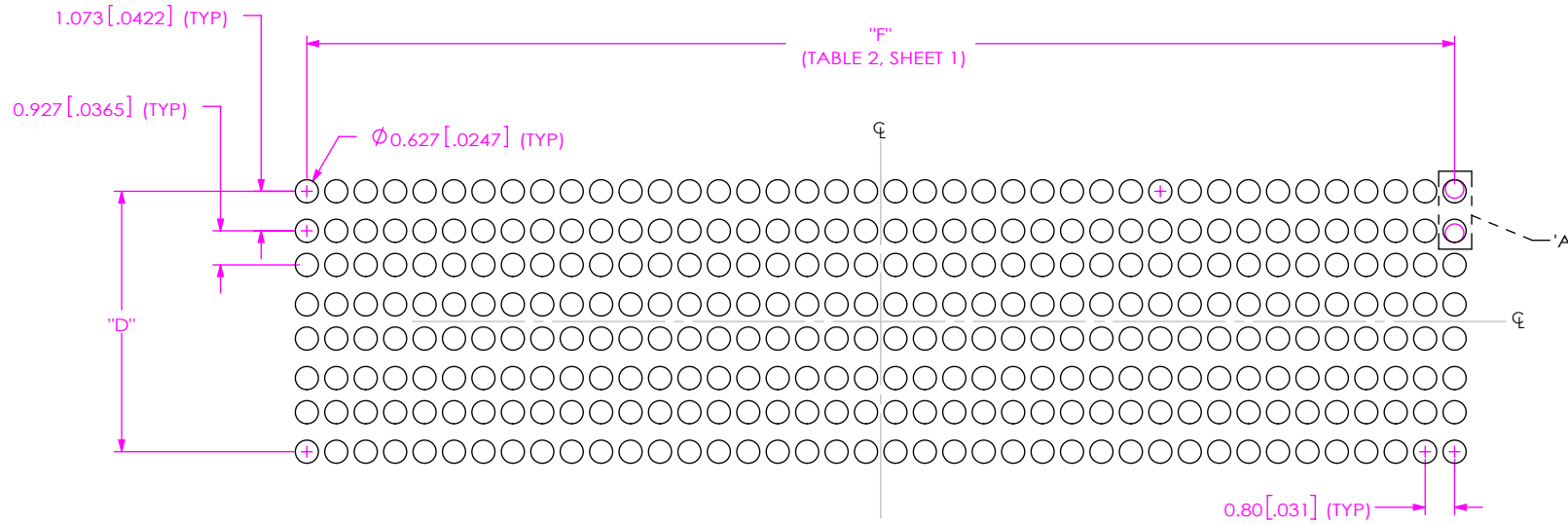

FIG 10  
SEAM8-XX-SXX.X-XXX-XX-2-XX-X-XX STENCIL SHOWN  
ALL DIMENSIONS ARE SYMMETRIC ABOUT THE CENTERLINE.

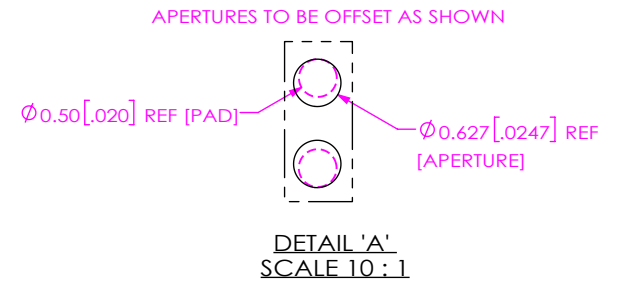

TABLE 4 (TYPE 2 SOLDER)	
No. OF ROWS	"D"
-04	3.073 [0.1210]
-06	5.073 [0.1997]
-08 (SEE NOTE 3)	7.073 [0.2785]
-10 (SEE NOTE 3)	9.073 [0.3572]

**PROPRIETARY NOTE**  
THIS DOCUMENT CONTAINS CONFIDENTIAL AND PROPRIETARY INFORMATION AND ALL DESIGN, MANUFACTURING, REPRODUCTION, USE, PATENT RIGHTS AND SALES RIGHTS ARE EXPRESSLY RESERVED BY SAMTEC, INC. THIS DOCUMENT SHALL NOT BE DISCLOSED, IN WHOLE OR PART, TO ANY UNAUTHORIZED PERSON OR ENTITY NOR REPRODUCED, TRANSFERRED OR INCORPORATED IN ANY OTHER PROJECT IN ANY MANNER WITHOUT THE EXPRESS WRITTEN CONSENT OF SAMTEC, INC.

**samtec**  
520 PARK EAST BLVD, NEW ALBANY, IN 47150  
PHONE: 812-944-6733 FAX: 812-948-5047  
e-Mail info@SAMTEC.com code 55322

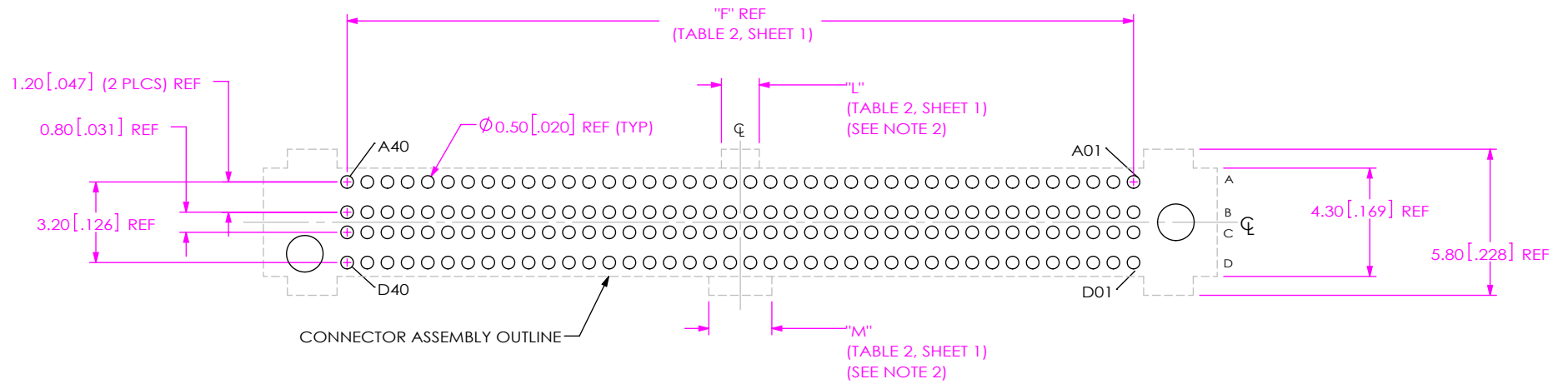

FIG 11  
SEAM8-40-SXX.X-XXX-04-2-XX-X-XX  
FOOTPRINT SHOWN

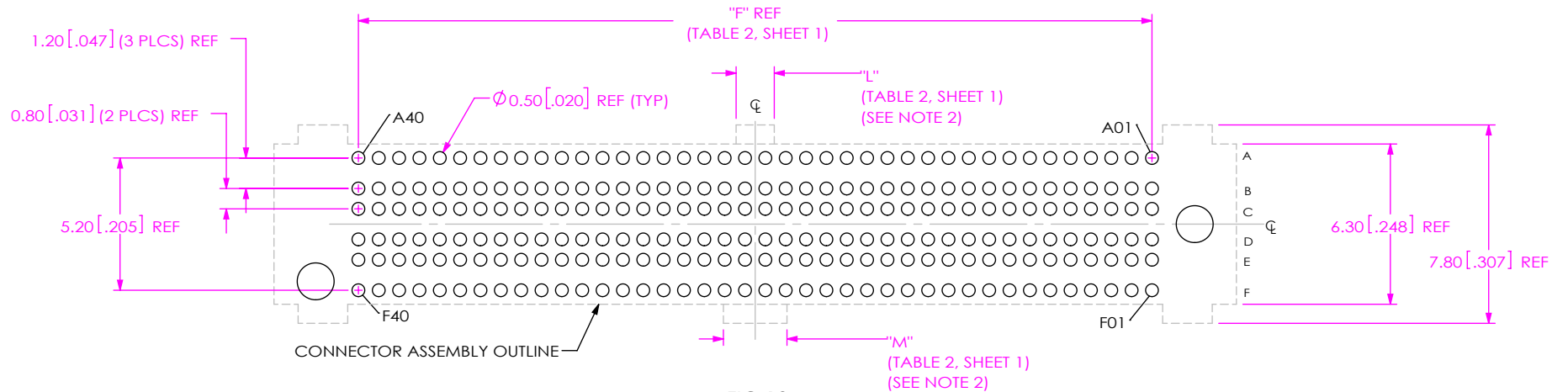

FIG 12  
SEAM8-40-SXX.X-XXX-06-2-XX-X-XX  
FOOTPRINT SHOWN

**PROPRIETARY NOTE**  
THIS DOCUMENT CONTAINS CONFIDENTIAL AND PROPRIETARY INFORMATION AND ALL DESIGN, MANUFACTURING, REPRODUCTION, USE, PATENT RIGHTS AND SALES RIGHTS ARE EXPRESSLY RESERVED BY SAMTEC, INC. THIS DOCUMENT SHALL NOT BE DISCLOSED, IN WHOLE OR PART, TO ANY UNAUTHORIZED PERSON OR ENTITY NOR REPRODUCED, TRANSFERRED OR INCORPORATED IN ANY OTHER PROJECT IN ANY MANNER WITHOUT THE EXPRESS WRITTEN CONSENT OF SAMTEC, INC.

**samtec**  
520 PARK EAST BLVD, NEW ALBANY, IN 47150  
PHONE: 812-944-6733 FAX: 812-948-5047  
e-Mail info@SAMTEC.com code 55322

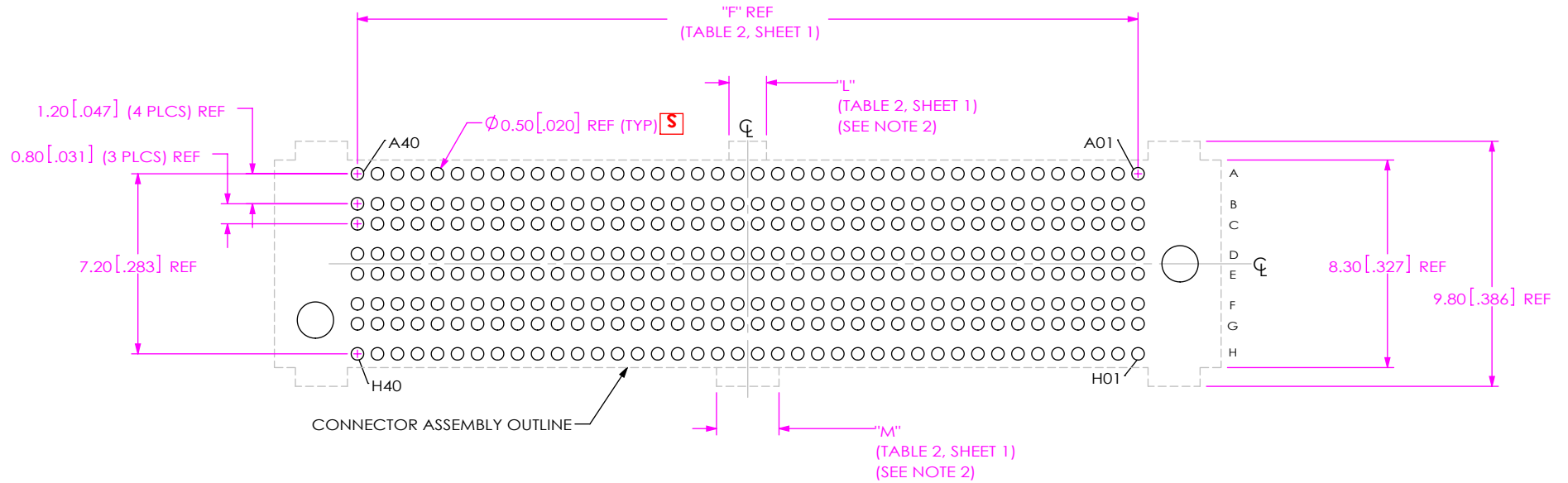

FIG 13  
SEAM8-40-SXX.X-XXX-08-2-XX-X-XX  
FOOTPRINT SHOWN

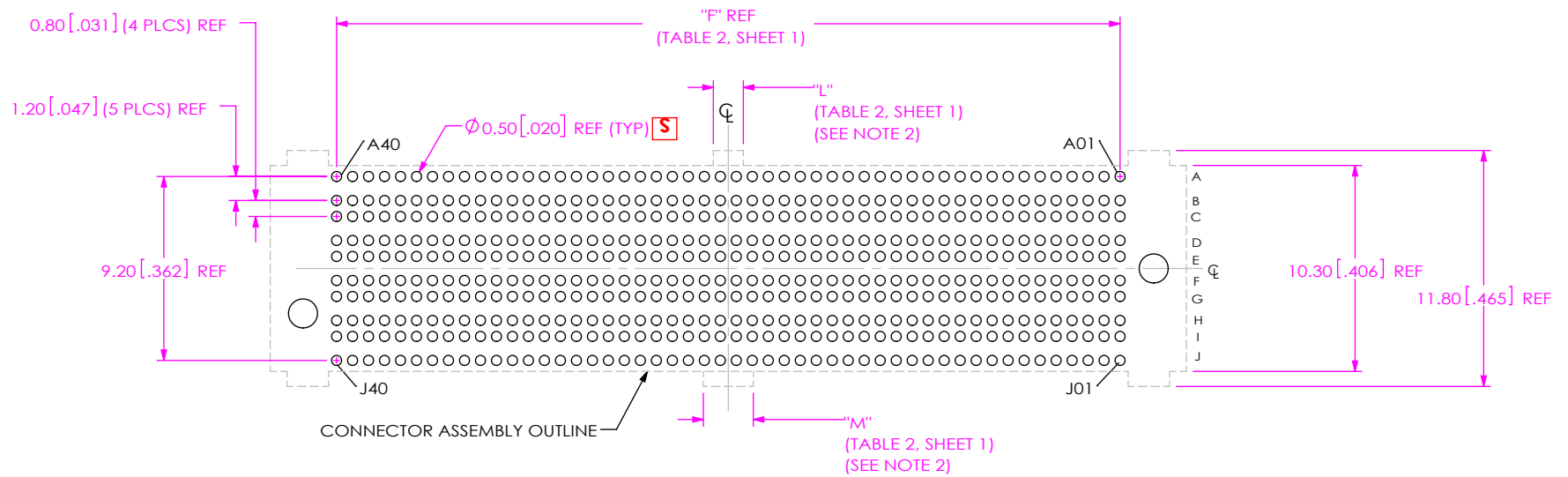

FIG 14  
SEAM8-40-SXX.X-XXX-10-2-XX-X-XX  
FOOTPRINT SHOWN

**PROPRIETARY NOTE**  
THIS DOCUMENT CONTAINS CONFIDENTIAL AND PROPRIETARY INFORMATION AND ALL DESIGN, MANUFACTURING, REPRODUCTION, USE, PATENT RIGHTS AND SALES RIGHTS ARE EXPRESSLY RESERVED BY SAMTEC, INC. THIS DOCUMENT SHALL NOT BE DISCLOSED, IN WHOLE OR PART, TO ANY UNAUTHORIZED PERSON OR ENTITY NOR REPRODUCED, TRANSFERRED OR INCORPORATED IN ANY OTHER PROJECT IN ANY MANNER WITHOUT THE EXPRESS WRITTEN CONSENT OF SAMTEC, INC.

**samtec**  
520 PARK EAST BLVD, NEW ALBANY, IN 47150  
PHONE: 812-944-6733 FAX: 812-948-5047  
e-Mail info@SAMTEC.com code 55322

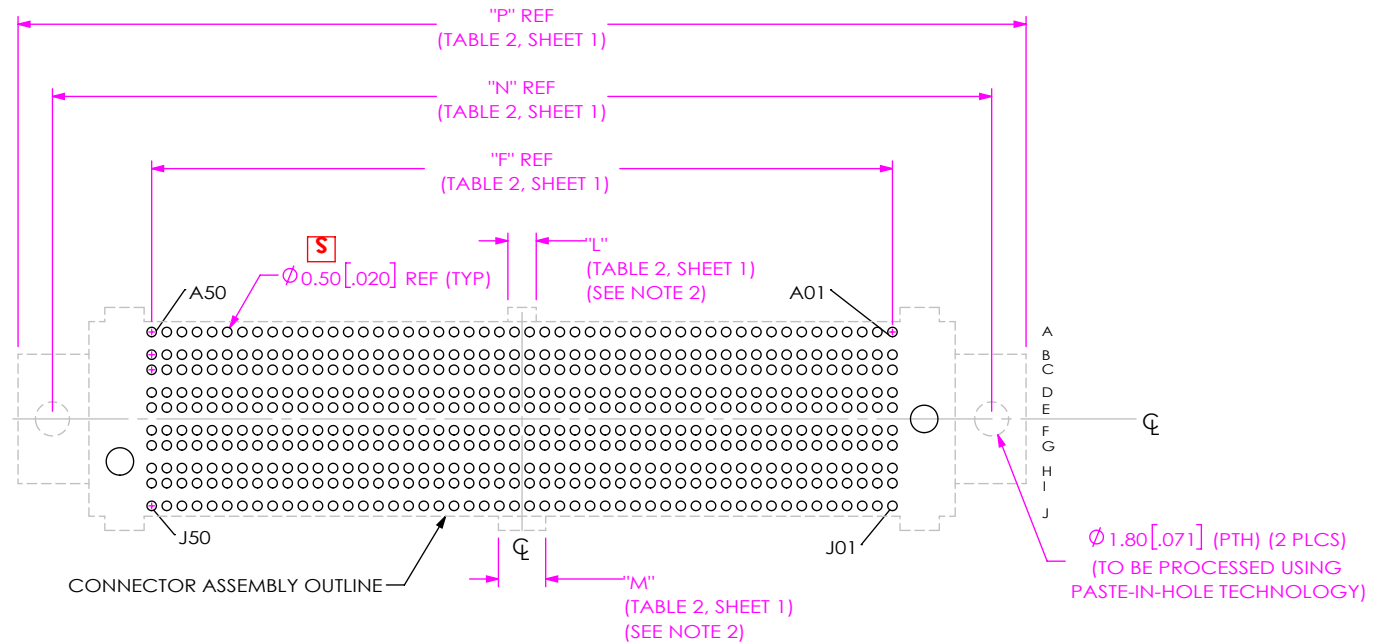

FIG 15  
(GUIDE POST OPTION)  
SEAM8-50-SXX.X-XXX-10-2-GP-X-XX FOOTPRINT SHOWN  
(SAME AS FIGS 1, 3, 4, 5 & 6, EXCEPT AS SHOWN)

**PROPRIETARY NOTE**

THIS DOCUMENT CONTAINS CONFIDENTIAL AND PROPRIETARY INFORMATION AND ALL DESIGN, MANUFACTURING, REPRODUCTION, USE, PATENT RIGHTS AND SALES RIGHTS ARE EXPRESSLY RESERVED BY SAMTEC, INC. THIS DOCUMENT SHALL NOT BE DISCLOSED, IN WHOLE OR IN PART, TO ANY UNAUTHORIZED PERSON OR ENTITY NOR REPRODUCED, TRANSFERRED OR INCORPORATED IN ANY OTHER PROJECT IN ANY MANNER WITHOUT THE EXPRESS WRITTEN CONSENT OF SAMTEC, INC.



520 PARK EAST BLVD, NEW ALBANY, IN 47150  
PHONE: 812-944-6733 FAX: 812-948-5047  
e-Mail info@SAMTEC.com code 55322

NOTE:  
STENCIL TO BE 0.127 [.0050] THICK.

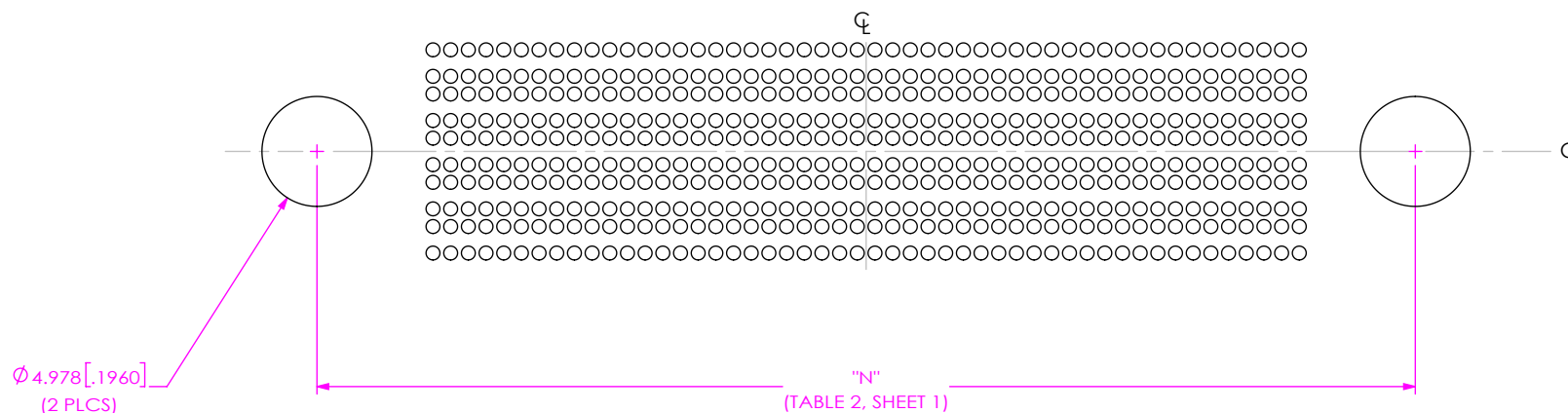
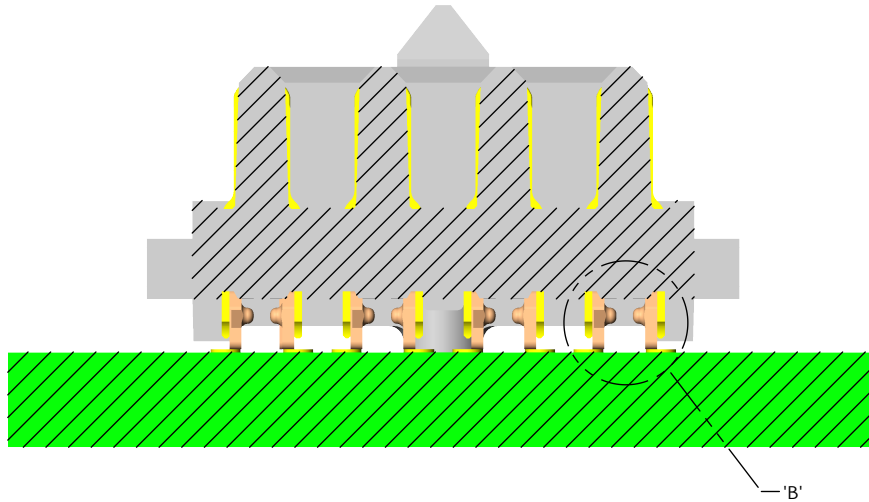

**FIG 16**  
(GUIDE POST OPTION)  
SEAM8-50-SXX.X-XXX-10-2-GP-X-XX STENCIL SHOWN  
(SAME AS FIG 2, EXCEPT AS SHOWN)  
ALL DIMENSIONS ARE SYMMETRIC ABOUT THE CENTERLINE.

**PROPRIETARY NOTE**  
THIS DOCUMENT CONTAINS CONFIDENTIAL AND PROPRIETARY INFORMATION AND ALL DESIGN, MANUFACTURING, REPRODUCTION, USE, PATENT RIGHTS AND SALES RIGHTS ARE EXPRESSLY RESERVED BY SAMTEC, INC. THIS DOCUMENT SHALL NOT BE DISCLOSED, IN WHOLE OR PART, TO ANY UNAUTHORIZED PERSON OR ENTITY NOR REPRODUCED, TRANSFERRED OR INCORPORATED IN ANY OTHER PROJECT IN ANY MANNER WITHOUT THE EXPRESS WRITTEN CONSENT OF SAMTEC, INC.



520 PARK EAST BLVD, NEW ALBANY, IN 47150  
PHONE: 812-944-6733 FAX: 812-948-5047  
e-Mail info@SAMTEC.com code 55322



BEFORE SOLDER VIEW  
SEAM8-XX-SXX.X-XXX-XX-2-XX-X-XX ASSY SHOWN

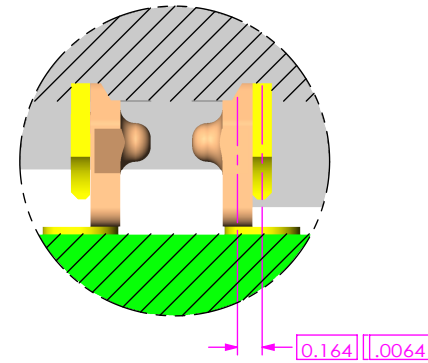

DETAIL 'B'  
SCALE 20 : 1

**PROPRIETARY NOTE**  
THIS DOCUMENT CONTAINS CONFIDENTIAL AND PROPRIETARY INFORMATION AND ALL DESIGN, MANUFACTURING, REPRODUCTION, USE, PATENT RIGHTS AND SALES RIGHTS ARE EXPRESSLY RESERVED BY SAMTEC, INC. THIS DOCUMENT SHALL NOT BE DISCLOSED, IN WHOLE OR PART, TO ANY UNAUTHORIZED PERSON OR ENTITY NOR REPRODUCED, TRANSFERRED OR INCORPORATED IN ANY OTHER PROJECT IN ANY MANNER WITHOUT THE EXPRESS WRITTEN CONSENT OF SAMTEC, INC.



520 PARK EAST BLVD, NEW ALBANY, IN 47150  
PHONE: 812-944-6733 FAX: 812-948-5047  
e-Mail info@SAMTEC.com code 55322