

DO NOT SCALE FROM THIS PRINT

DESIGNED & DIMENSIONED IN MILLIMETERS[INCHES]

SEAF8-XX-X-X-XX-X-RA-XX-XX

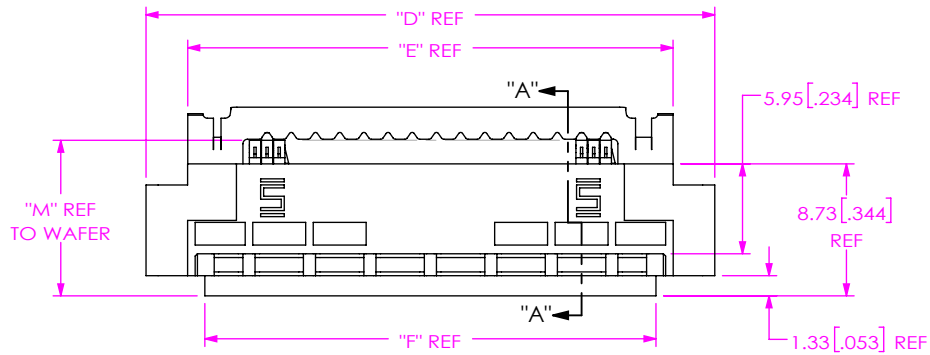

**No OF POSITIONS**  
 \*-10, -20, -30, -40, -50 (PER ROW)  
**LEAD STYLE**  
 -1  
**PLATING SPECIFICATION**  
 -S: 30µ" SELECTIVE GOLD IN CONTACT AREA, MATTE TIN ON TAIL (USE SUB-IM-C-293-XX-XX-S-X)  
**No OF ROWS**  
 -04: 4 ROWS (ONLY AVAILABLE IN 50 POSITION)  
 \*-06: 6 ROWS  
 -08: 8 ROWS (SEE NOTE 8)  
 -10: 10 ROWS (SEE NOTE 8)

**PACKAGING**  
 BLANK: TAPE & REEL (SEE NOTES 4, 6 & 9)  
 -FR: FULL REEL QTY TAPE & REEL (SEE NOTES 6 & 9)  
**OPTION**  
 -GP: GUIDE POST  
**RIGHT ANGLE**  
 -RA  
**SOLDER COMPOSITION & STYLE**  
 2: 95.5% TIN / 3.8% SILVER / 0.7% COPPER LEAD FREE CHARGE TAIL (USE SUB-IM-C-293-XX-XX-X-2)  
 (\* = NOT TOOLED)

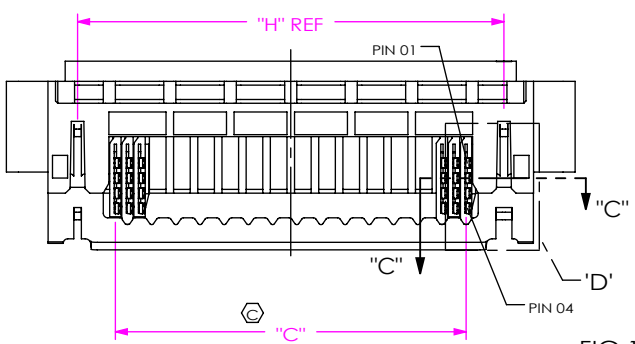
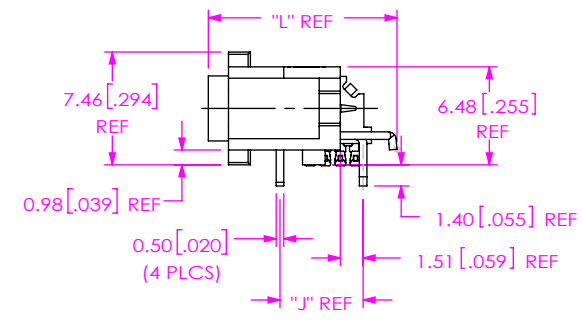
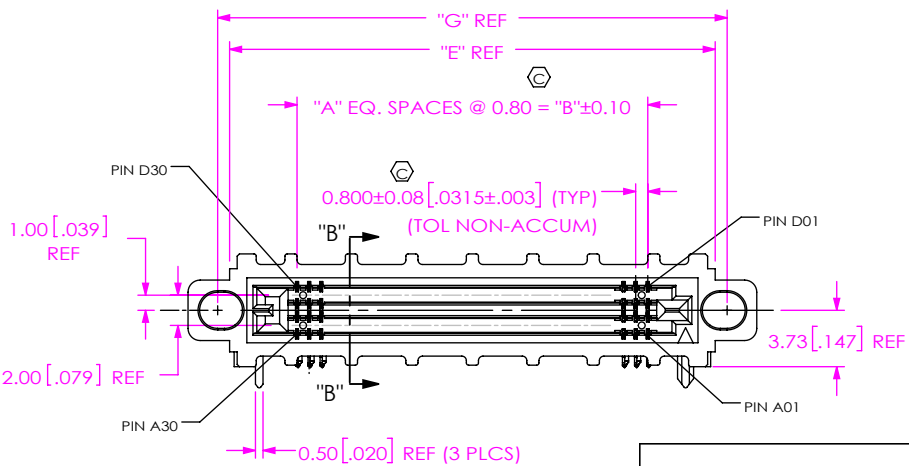

FIG 1 (SEAF8-30-1-X-04-X-RA-GP SHOWN) (SOME CENTER FEATURES REMOVED FOR CLARITY)

ROWS	"J"	"K"	"L"	"M"	"N"	"P"	"Q"	"R"
-04	5.50 [0.217]	9.42 [0.371]	12.48 [0.491]	10.29 [0.405]	10.24 [0.403]	0.55 [0.022]	0.21 [0.008]	0.71 [0.028]
-06	7.50 [0.295]	11.42 [0.450]	14.48 [0.570]	12.29 [0.484]	12.24 [0.482]	0.65 [0.026]	0.22 [0.009]	0.72 [0.028]
-08	9.50 [0.374]	13.42 [0.528]	16.48 [0.649]	14.29 [0.563]	14.24 [0.561]	0.65 [0.026]	0.22 [0.009]	0.72 [0.028]
-10	11.50 [0.453]	15.42 [0.607]	18.48 [0.728]	16.29 [0.641]	16.24 [0.639]	0.65 [0.026]	0.22 [0.009]	0.72 [0.028]

No. OF POS	"A"	"B"	"C"	"D"	"E"	"F"	"G"	"H"
-10	9	7.200 [0.2835]	7.20 [0.283]	21.62 [0.851]	16.12 [0.635]	13.84 [0.545]	17.70 [0.697]	12.20 [0.487]
-20	19	15.200 [0.5984]	15.20 [0.598]	29.62 [1.166]	24.12 [0.950]	21.84 [0.860]	25.70 [1.012]	20.20 [0.802]
-30	29	23.200 [0.9134]	23.20 [0.913]	37.62 [1.481]	32.12 [1.265]	29.84 [1.175]	33.70 [1.327]	28.20 [1.117]
-40	39	31.200 [1.2283]	31.20 [1.228]	45.62 [1.796]	40.12 [1.580]	37.84 [1.490]	41.70 [1.642]	36.20 [1.432]
-50	49	39.200 [1.5433]	39.20 [1.543]	53.62 [2.111]	48.12 [1.894]	45.84 [1.805]	49.70 [1.957]	44.20 [1.747]

- NOTES:
- ⊕ REPRESENTS A CRITICAL DIMENSION.
  - MINIMUM PUSHOUT FORCE: 2.22N [0.5 LB].
  - NOTE DELETED.
  - TAPE & REEL IS STANDARD PACKAGING.
  - NOTE DELETED.
  - ATTACH LABEL "SEAX-0001" TO EACH REEL.
  - MINIMUM PUSHOUT FORCE: 8.9N [2.0 LB.]
  - 08 & -10 ROW ARE RELEASED FOR NITROGEN ENVIRONMENT PROCESSING ONLY. NOT RECOMMENDED FOR AIR ONLY PROCESSING.
  - ORDERS WILL BE PACKAGED ACCORDING TO THE SAMTEC PACKAGING EFFICIENCY STANDARDS (SPES) FOUND ON WWW.SAMTEC.COM.

UNLESS OTHERWISE SPECIFIED, DIMENSIONS ARE IN MILLIMETERS[INCHES]. TOLERANCES ARE:  
 DECIMALS ANGLES  
 X.X: ±0.3 [0.1] 2°  
 X.XX: ±0.13 [0.05]  
 X.XXX: ±0.051 [0.020]

**PROPRIETARY NOTE**  
 THIS DOCUMENT CONTAINS CONFIDENTIAL AND PROPRIETARY INFORMATION AND ALL DESIGN, MANUFACTURING, REPRODUCTION, USE, PATENT RIGHTS AND SALES RIGHTS ARE EXPRESSLY RESERVED BY SAMTEC, INC. THIS DOCUMENT SHALL NOT BE DISCLOSED, IN WHOLE OR PART, TO ANY UNAUTHORIZED PERSON OR ENTITY NOR REPRODUCED, TRANSFERRED OR INCORPORATED IN ANY OTHER PRODUCT IN ANY MANNER WITHOUT THE EXPRESS WRITTEN CONSENT OF SAMTEC, INC.

**MATERIAL:** DO NOT SCALE DRAWING SHEET SCALE: 2:1  
 INSULATOR: LCP, UL-94V-0; COLOR: BLACK  
 CONTACT: COPPER ALLOY  
 WELD TAB: COPPER ALLOY

520 PARK EAST BLVD, NEW ALBANY, IN 47150  
 PHONE: 812-944-6733 FAX: 812-948-5047  
 e-Mail: info@SAMTEC.com code 55322

DESCRIPTION:  
 0.80MM PITCH RA SOCKET ARRAY ASSY

DWG. NO.  
 SEAF8-XX-X-X-XX-X-RA-XX-XX

BY: KNOWLDEN 7/9/2013 SHEET 1 OF 4

REVISION K

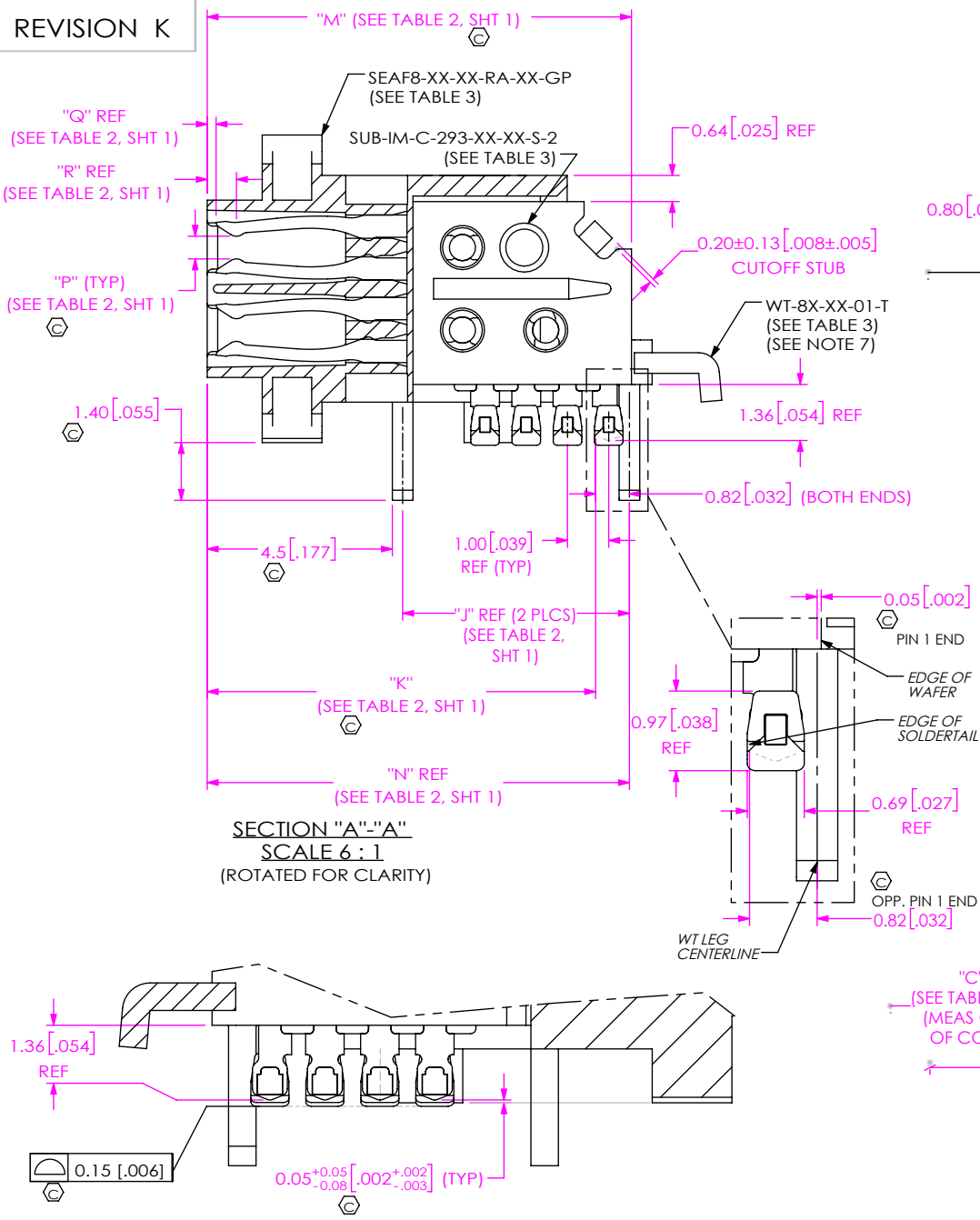

SECTION "A"-"A"  
SCALE 6:1  
(ROTATED FOR CLARITY)

SECTION "B"-"B"  
SCALE 8:1

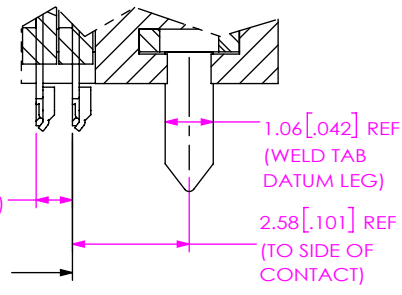

SECTION "C"-"C"  
SCALE 6:1

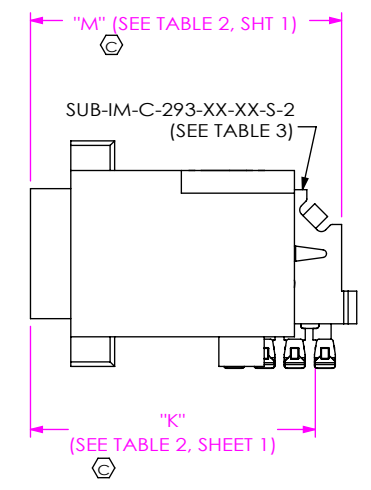
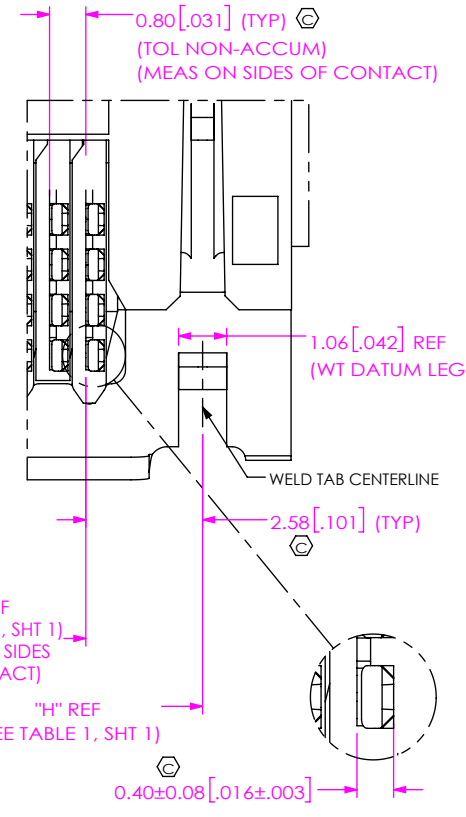

IN-PROCESS 1  
(FILL SUB-IM-C-293)  
(TYPICAL ALL WAFERS)

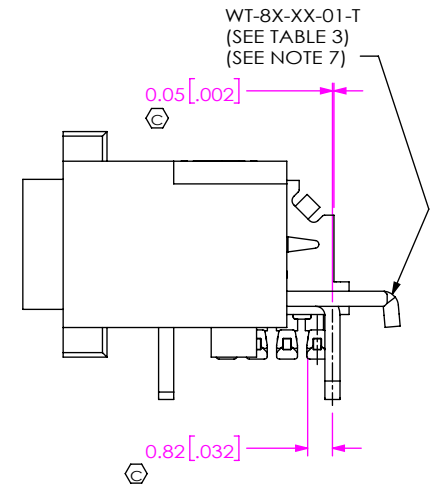

IN-PROCESS 2  
(FILL WT-8X-XX-T)

DETAIL 'D'  
SCALE 6:1

ROWS	"BODY CALLOUT"	"CONTACT WAFER"	"WELD TAB"
-04	SEAF8-XX-XX-RA-04-XX	SUB-IM-C-293-XX-04-XX	WT-82-XX-01-T
-06	SEAF8-XX-XX-RA-06-XX	SUB-IM-C-293-XX-06-XX	WT-82-XX-02-T
-08	SEAF8-XX-XX-RA-08-XX	SUB-IM-C-293-XX-08-XX	WT-85-XX-01-T
-10	SEAF8-XX-XX-RA-10-XX	SUB-IM-C-293-XX-10-XX	WT-85-XX-02-T

**PROPRIETARY NOTE**  
THIS DOCUMENT CONTAINS CONFIDENTIAL AND PROPRIETARY INFORMATION AND ALL DESIGN, MANUFACTURING, REPRODUCTION, USE, PATENT RIGHTS AND SALES RIGHTS ARE EXPRESSLY RESERVED BY SAMTEC, INC. THIS DOCUMENT SHALL NOT BE DISCLOSED, IN WHOLE OR PART, TO ANY UNAUTHORIZED PERSON OR ENTITY NOR REPRODUCED, TRANSFERRED OR INCORPORATED IN ANY OTHER PROJECT IN ANY MANNER WITHOUT THE EXPRESS WRITTEN CONSENT OF SAMTEC, INC.

DO NOT SCALE DRAWING  
SHEET SCALE: 2:1



520 PARK EAST BLVD, NEW ALBANY, IN 47150  
PHONE: 812-944-6733 FAX: 812-948-5047  
e-Mail: info@SAMTEC.com code 55322

DESCRIPTION:  
0.80MM PITCH RA SOCKET ARRAY ASSY  
DWG. NO.  
SEAF8-XX-X-X-XX-X-RA-XX-XX  
BY: KNOWLDEN 7/9/2013 SHEET 2 OF 4

REVISION K

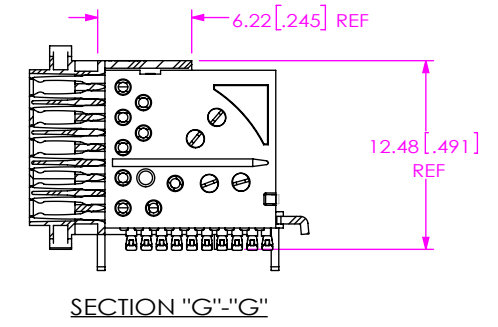
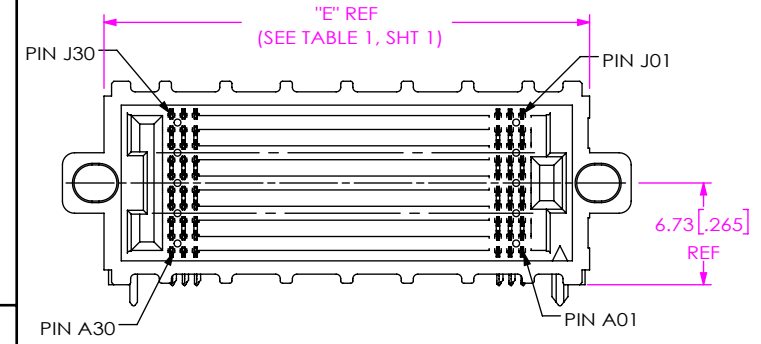
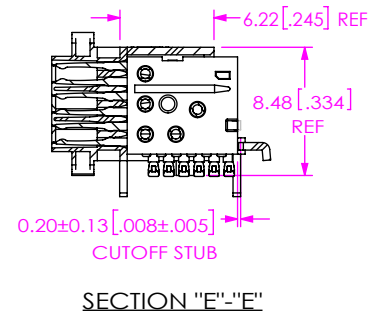
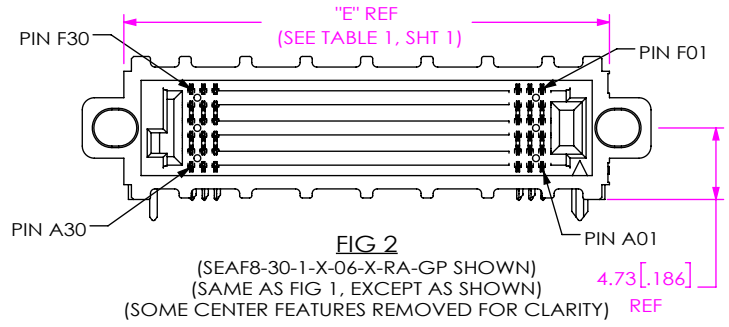
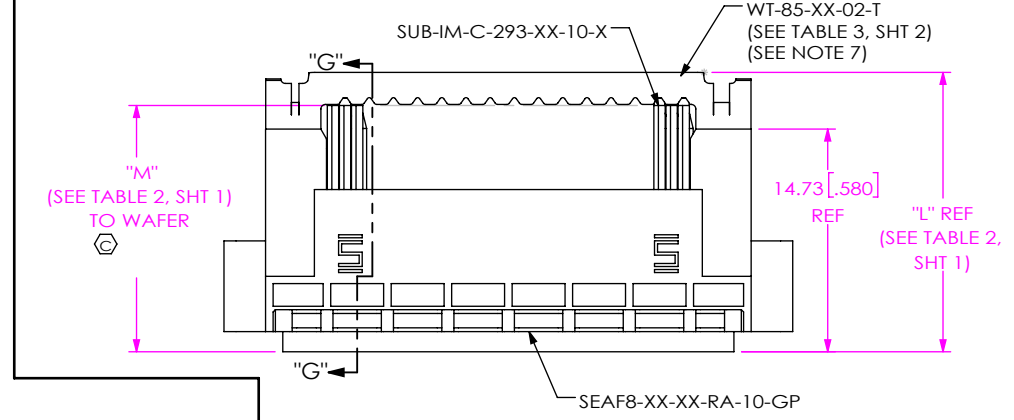
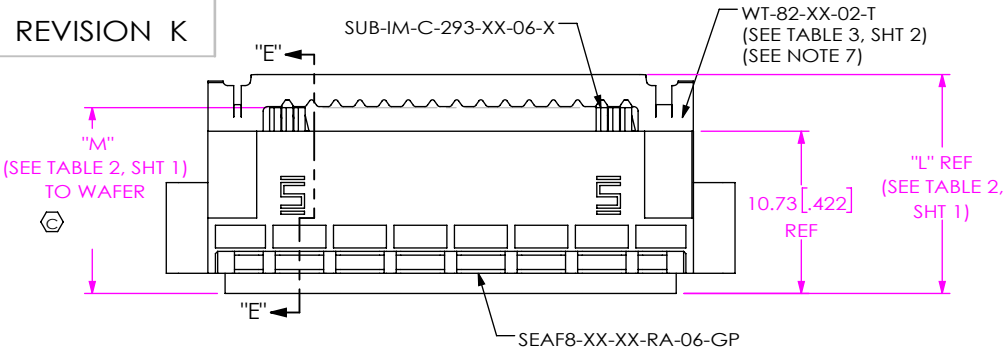
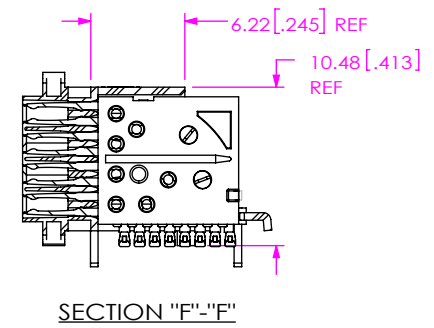
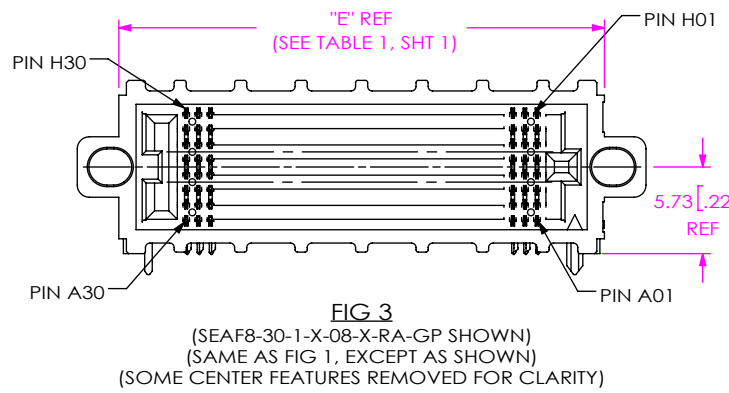
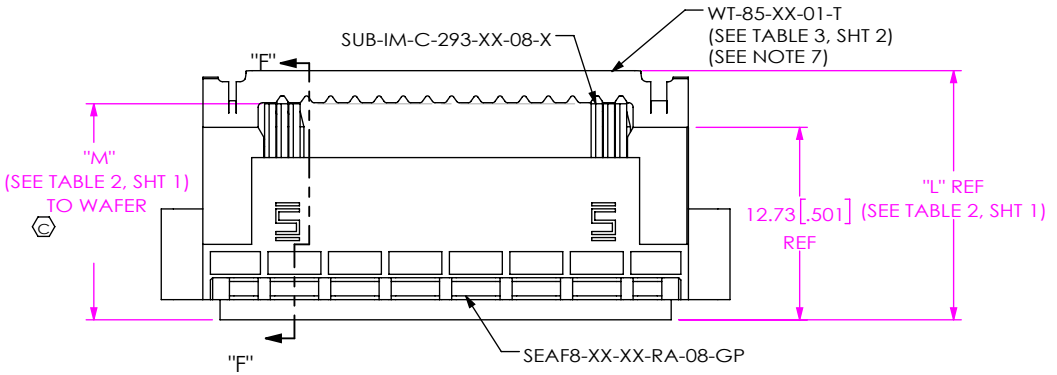

FIG 4  
(SEAF8-30-1-X-10-X-RA-GP SHOWN)  
(SAME AS FIG 1, EXCEPT AS SHOWN)  
(SOME CENTER FEATURES REMOVED FOR CLARITY)



**PROPRIETARY NOTE**  
THIS DOCUMENT CONTAINS CONFIDENTIAL AND PROPRIETARY INFORMATION AND ALL DESIGN, MANUFACTURING, REPRODUCTION, USE, PATENT RIGHTS AND SALES RIGHTS ARE EXPRESSLY RESERVED BY SAMTEC, INC. THIS DOCUMENT SHALL NOT BE DISCLOSED, IN WHOLE OR PART, TO ANY UNAUTHORIZED PERSON OR ENTITY NOR REPRODUCED, TRANSFERRED OR INCORPORATED IN ANY OTHER PROJECT IN ANY MANNER WITHOUT THE EXPRESS WRITTEN CONSENT OF SAMTEC, INC.

DO NOT SCALE DRAWING  
SHEET SCALE: 2:1

**samtec**  
520 PARK EAST BLVD, NEW ALBANY, IN 47150  
PHONE: 812-944-6733 FAX: 812-948-5047  
e-Mail info@SAMTEC.com code 55322

DESCRIPTION:  
0.80MM PITCH RA SOCKET ARRAY ASSY  
DWG. NO.  
SEAF8-XX-X-X-XX-X-RA-XX-XX  
BY: KNOWLDEN 7/9/2013 SHEET 3 OF 4

NO GUIDE POST VERSION

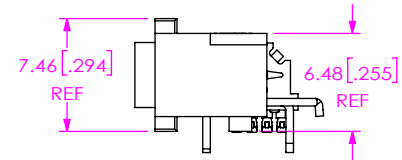
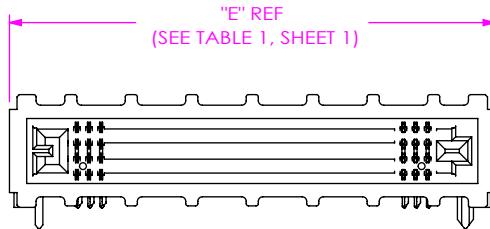
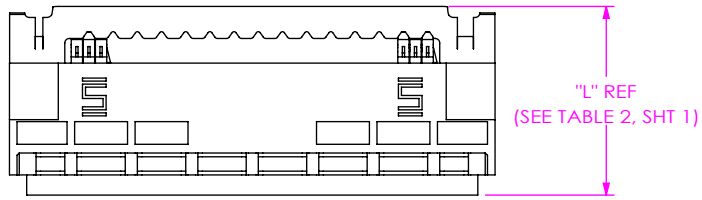

FIG 5  
 (SEAF8-30-1-X-04-X-RA SHOWN)  
 (SAME AS FIG 1, EXCEPT AS SHOWN)  
 (SOME CENTER FEATURES REMOVED FOR CLARITY)

**PROPRIETARY NOTE**  
 THIS DOCUMENT CONTAINS CONFIDENTIAL AND PROPRIETARY INFORMATION AND ALL DESIGN, MANUFACTURING, REPRODUCTION, USE, PATENT RIGHTS AND SALES RIGHTS ARE EXPRESSLY RESERVED BY SAMTEC, INC. THIS DOCUMENT SHALL NOT BE DISCLOSED, IN WHOLE OR PART, TO ANY UNAUTHORIZED PERSON OR ENTITY NOR REPRODUCED, TRANSFERRED OR INCORPORATED IN ANY OTHER PROJECT IN ANY MANNER WITHOUT THE EXPRESS WRITTEN CONSENT OF SAMTEC, INC.

DO NOT SCALE DRAWING

SHEET SCALE: 2:1



520 PARK EAST BLVD, NEW ALBANY, IN 47150  
 PHONE: 812-944-6733 FAX: 812-948-5047  
 e-Mail info@SAMTEC.com code 55322

DESCRIPTION:  
 0.80MM PITCH RA SOCKET ARRAY ASSY

DWG. NO.  
 SEAF8-XX-X-X-XX-X-RA-XX-XX

BY: KNOWLDEN 7/9/2013 SHEET 4 OF 4