

Technology Manual

G AND I SERIES DIGITAL THERMAL BASED MFC



Copyright © 2023 by MKS Instruments, Inc.

All rights reserved. No part of this work may be reproduced or transmitted in any form or by any means, electronic or mechanical, including photocopying and recording, or by any information storage or retrieval system, except as may be expressly permitted in writing by MKS Instruments, Inc.

Printed in the United States of America

Baratron® is a registered trademark of MKS Instruments, Inc.

Swagelok®, VCO®, and VCR® are registered trademarks of Swagelok Company, Solon, OH

Inconel® is a registered trademark of Inco Alloys, Inc. Huntington, WV

All other product names herein are used for identification purposes only and are recognized as properties (including trademarks, registered trademarks, and referenced copyrighted materials) of their respective companies.

Protected by U. S. patents pending and foreign patents pending.

Table of Contents

List of Figures	7
List of Tables	8
1 Warranty	11
2 Safety Information	12
2.1 Mass Flow Controller Safety Information	12
2.1.1 Symbols Used in This Instruction Manual	12
2.1.2 Symbols Found on the Unit	13
2.1.3 Safety Procedures and Precautions	13
2.2 Sicherheitshinweise für das Massenflussgerät	15
2.2.1 In dieser Betriebsanleitung vorkommende Symbole ual	15
2.2.2 Erklärung der am Gerät angebrachten Symbole	15
2.2.3 Sicherheitsvorschriften und Vorsichtsmaßnahmen	16
2.3 Informations de sécurité pour appareils de mesure/contrôle de débit massique	18
2.3.1 Symboles utilisés dans ce manuel d'utilisation	18
2.3.2 Symboles figurant sur l'unité	18
2.3.3 Mesures de sécurité et précautions	19
2.4 Medidas de seguridad del dispositivo de flujo de masa	21
2.4.1 Símbolos usados en este manual de instrucciones	21
2.4.2 Símbolos hallados en la unidad	21
2.4.3 Procedimientos y precauciones de seguridad	22
2.5 マスフロー機器の安全に関する情報	24
2.5.1 この取扱説明書で使用されているシンボル	24

- 2.5.2 本機器のマーク24
- 2.5.3 安全対策について25
- 2.6 질량 유량 장치 안전 정보27
 - 2.6.1 본 지침 매뉴얼에 사용되는 기호들27
 - 2.6.2 장치에 표시된 기호들27
 - 2.6.3 안전 절차 및 예방조치28
- 3 Overview31
 - 3.1 Product Support Documents32
 - 3.2 Manual References32
 - 3.3 Product Description Guide33
 - 3.4 General MFC Overview and Features35
 - 3.4.1 Performance35
 - 3.4.2 Multi Gas and Multi-Range Functions35
 - 3.4.3 User Interface and MFC Diagnostics36
 - 3.4.4 MFC Reliability36
 - 3.5 MFC Cleanliness37
 - 3.6 Specifications37
 - 3.7 Mechanical Dimensions41
- 4 Installation and MFC Setup45
 - 4.1 Considering the MFC Installation Environment45
 - 4.1.1 MFC Installation Environment45
 - 4.2 Pre-Installation Safety Considerations46
 - 4.3 Unpacking the MFC in a Clean Environment46

- 4.4 Mounting Hardware for Installing the MFC.....47
- 4.5 Checking the Leak Tight Seal for the MFC49
- 4.6 Applying Power and Signal Cables to the MFC49
 - 4.6.1 Analog Power and Control I/O Definitions.....51
 - 4.6.2 Digital I/O Connections.....53
- 4.7 Leak Checking the MFC Installation59
- 4.8 Setting Up and Configuring the MFC59
- 4.9 Zeroing the MFC60
 - 4.9.1 Check Temperature Stabilization60
 - 4.9.2 Establish a Proper “No Flow” Condition Across the MFC Control Valve60
- 5 MFC Product Code Definition and Design Configurations.....62
 - 5.1 G and I Series Elastomer Models62
 - 5.1.1 Elastomer Sealed G and I Series Product Code Structure62
 - 5.1.2 MFC Configuration Code – CCCCC62
 - 5.1.3 Gas Code – GGG.....62
 - 5.1.4 Flow Full Scale Range Designation – FFF.....63
 - 5.1.5 MFC Fittings – Y.....64
 - 5.1.6 MFC Power and Control I/O Connector – W.....65
 - 5.1.7 Elastomer Seal Materials – Z.....66
 - 5.1.8 Valve Type – V.....67
 - 5.1.9 Firmware Revision – AA.....67
 - 5.2 G and I Series Metal Sealed Model67
 - 5.2.1 Metal Sealed G and I Series Product Code Structure67
 - 5.2.2 MFC Configuration Code – CCCCC68

- 5.2.3 Gas Code – GGG68
- 5.2.4 Full Scale Range – FFF69
- 5.2.5 Fittings – Y70
- 5.2.6 Power and Control I/O Connector – W.....72
- 5.2.7 Valve Type – V73
- 5.2.8 Firmware Revision – AA.....74
- 6 Troubleshooting and Maintenance.....75
 - 6.1 MFC Setup and Function Troubleshooting75
 - 6.2 MFC Performance Troubleshooting84
 - 6.3 Digital Communication Troubleshooting86
 - 6.3.1 DeviceNet86
 - 6.3.2 RS485 Serial Communication88
 - 6.3.3 Profibus Communication89
 - 6.3.4 Ethercat Communication90
 - 6.3.5 Profinet Communication92
 - A. SEMI Gas Codes and MFC Flow Range Summary.....93
 - 6.4 G and I Series MFC Relationship with SEMI Gas Code Numbers93
 - B. MFC Web Browser108
 - Communicating with the MFC via Ethernet.....108
 - Opening the Web Browser – Monitor Mode.....112
 - Going to the Setup Mode114
 - Utilizing the Plot Page and Saving Data116
 - C. Electrical Cables and Accessories125
 - D. IP Rating for the I Series MFC and What It Means127

- E. Modbus Operation.....128
 - Enabling Modbus TCP/IP Control128
 - Modbus Labview Library128
 - MKS Example VI129
- F. Analog Optional Input.....131
 - Setup Mode: Optional Input Tab131
 - Optional Input Plot Page134

List of Figures

- Figure 1: MFCs G and I Series.....31
- Figure 2: MFC Mechanical Dimensions.....41
- Figure 3: Mounting Screw Holes Locations for In-Line Axial Gas Flow Compression Fittings48
- Figure 4: Mounting Bolt Holes Location for Non-Axial Gas Flow Compression Fittings49
- Figure 5: Analog I.O – 15 pin.....51
- Figure 6: Analog I.O – 9 pin.....51
- Figure 7: Analog I.O – 4-20 mA.....52
- Figure 8: RS485 Communication Protocol53
- Figure 9: DeviceNet Communication Protocol54
- Figure 10: DeviceNet 4-Position Rotary Switch55
- Figure 11: DeviceNet Pair of Rotary Switches56
- Figure 12: Profibus I/O Communications Protocol56
- Figure 13: EtherCat I/O Communications Protocol57
- Figure 14: Profinet I/O Communications Protocol58
- Figure 15: Basic Network Information109
- Figure 16: Local Area Connection Status.....109
- Figure 17: Internet Protocol Version 4.....110
- Figure 18: Properties111

Figure 19: IP Settings112

Figure 20: Device Page in Monitor Mode113

Figure 21: Enter Password to Change Settings114

Figure 22: Additional Tabs.....115

Figure 23: ToolWeb Folder117

Figure 24: Java Web Site118

Figure 25: Java Folder from Download119

Figure 26: Security Folder119

Figure 27: Java Policy Security Document in the Security Folder120

Figure 28: Java Policy Security Document.....121

Figure 29: Java Folder.....121

Figure 30: Security Tab122

Figure 31: Exception Site List.....123

Figure 32: Security Warning123

Figure 33: Security Window.....124

Figure 34: Configuration Page.....128

Figure 35: Configuration Page.....129

Figure 36: MKS Modbus MFC Example130

Figure 37: Basic Wiring Diagram for Optional Input (Downstream Control Example)132

Figure 38: Optional Input Page.....133

Figure 39: Optional Input Plot Page134

Figure 40: Optional Input Plot Page Example135

List of Tables

Table 1: G Series MFC33

Table 2: I Series MFC35

Table 3: General Performance and Design Specification37

Table 4: Electrical Specification.....39

Table 5: Mechanical and Material Specification39

Table 6: Fitting Design and MFC Length.....41

Table 7: Elastomer Sealed MFC Model Height Dimensions42

Table 8: Mounting Pattern Hardware: Fitting Types by Model	47
Table 9: MFC Configuration Code – CCCCC	62
Table 10: Flow Full Scale Range Designation – FFF	63
Table 11: MFC Fittings – Y	64
Table 12: Analog Control I/O	65
Table 13: Digital I/O Protocols	66
Table 14: Elastomer Seal Materials – Z	66
Table 15: Valve Type – V	67
Table 16: MFC Configuration Code – CCCCC	68
Table 17: Full Scale Range– FFF	69
Table 18: Fittings – Y	70
Table 19: Analog Control I/O	72
Table 20: Digital I/O	73
Table 21: Valve Type – V	73
Table 22: MFC Setup and Function Troubleshooting	75
Table 23: MFC Performance Troubleshooting	84
Table 24: DeviceNet Status LED	86
Table 25: Module (MOD) LED	87
Table 26: DeviceNet Connectivity	87
Table 27: RS485 LED Status	88
Table 28: RS485 Connectivity	88
Table 29: Profibus LED Status	89
Table 30: Profibus Connectivity	90
Table 31: Ethercat LED Status	90
Table 32: Ethercat Connectivity	91
Table 33: Profinet LED Status	92
Table 34: Profinet Connectivity	92
Table 35: SEMI Process Gas Definition	94
Table 36: Standard SEMI Gas Mixtures	99
Table 37: Non Standard Gas Mixtures	103
Table 38: Basic Features in the Setup Mode	115

Table 39: Analog Power and Signal I/O Cables125

1 Warranty

G and I Series Mass Flow Controllers

MKS Instruments, Inc. (MKS) warrants that for one (1) year from the date of shipment the equipment which is described above and manufactured by MKS, shall be free from defects in materials and workmanship.

For the period commencing with the date of shipment of this equipment and ending one (1) year later, MKS will, at its option, either repair or replace any part which is defective in materials or workmanship without charge to the purchaser. The foregoing shall constitute the exclusive and sole remedy of the purchaser for any breach of MKS of this warranty.

The purchaser, before returning any equipment covered by this warranty, which is asserted to be defective by the purchaser, shall make specific written arrangements with respect to the responsibility for shipping the equipment and handling any other incidental charges with the MKS Sales Representative or distributor from which the equipment was purchased or, in the case of a direct purchase from MKS, with the MKS home office in Andover, Massachusetts, USA.

This warranty does not apply to any equipment which has not been installed and used in accordance with the specifications recommended by MKS for the proper and normal use of the equipment. MKS shall not be liable under any circumstances for indirect, special, consequential, or incidental damages in connection with, or arising out of, the sale, performance, or use of the equipment covered by this warranty.

MKS recommends that all MKS pressure and flow products be calibrated periodically (typically) every 6 to 12 months) to ensure accurate readings. When a product is returned to MKS for this periodic re-calibration it is considered normal preventative maintenance not covered by any warranty.

THIS WARRANTY IS IN LIEU OF ALL OTHER RELEVANT WARRANTIES, EXPRESSED OR IMPLIED, INCLUDING THE IMPLIED WARRANTY OF MERCHANTABILITY AND THE IMPLIED WARRANTY OF FITNESS FOR A PARTICULAR PURPOSE, AND ANY WARRANTY AGAINST INFRINGEMENT OF ANY PATENT.

2 Safety Information

The following general safety precautions must be observed during all phases of operation of this instrument. Failure to comply with these precautions or with specific warnings elsewhere in this manual violates safety standards of intended use of the instrument and may impair the protection provided by the equipment. MKS Instruments, Inc. assumes no liability for the customer’s failure to comply with these requirements.

DO NOT SUBSTITUTE PARTS OR MODIFY INSTRUMENT

Do not install substitute parts or perform any unauthorized modification to the instrument. Return the instrument to an MKS Calibration and Service Center for service and repair to ensure that all safety features are maintained.

SERVICE BY QUALIFIED PERSONNEL ONLY

Operating personnel must not remove instrument covers. Component replacement and internal adjustments must be made by qualified service personnel only.

2.1 Mass Flow Controller Safety Information

2.1.1 Symbols Used in This Instruction Manual

The following are definitions of WARNING, CAUTION, and NOTE messages used throughout the manual.

NOTE

The NOTE sign denotes important information. It calls attention to a procedure, practice, condition, or the like, which is essential to highlight.

CAUTION











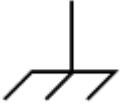

The CAUTION sign denotes a hazard. It calls attention to an operating procedure, practice, or the like, which, if not correctly performed or adhered to, could result in damage to or destruction of all or part of the product.

WARNING

The WARNING sign denotes a hazard. It calls attention to a procedure, practice, condition, or the like, which, if not correctly performed or adhered to, could result in injury to personnel.

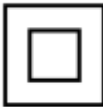
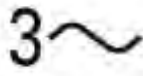
2.1.2 Symbols Found on the Unit

The following table describes symbols that may be found on the unit.

 <p>ON (Supply) IEC 417, No. 5007</p>	 <p>OFF (Supply) IEC 417, No. 5008</p>	 <p>Earth (ground) IEC 417, No. 5017</p>	 <p>Protective earth (ground) IEC 417, No. 5019</p>
 <p>Frame or Chassis IEC 417, No. 5020</p>	 <p>Equipotentiality IEC 417, No. 5021</p>	 <p>Direct current IEC 417, No. 5031</p>	 <p>Alternating current IEC 417, No. 5032</p>
 <p>Both direct and alternating current IEC 417, No. 5019</p>		 <p>Class II equipment IEC 417, No. 5172-a</p>	 <p>Three phase alternating current IEC 617-2, No. 020206</p>
 <p>Caution refer to accompanying documents ISO 3864, No. B.3 1</p>	 <p>Caution risk of electric shock ISO 3864, No. B.3 6</p>	 <p>Caution hot surface IEC 417, No. 5021</p>	

2.1.3 Safety Procedures and Precautions

Observe the following general safety precautions during all phase of operation of this instrument. Failure to comply with these precautions or with specific warnings elsewhere in this manual violates safety standards of intended use of the instrument and may impair the protection provided by the equipment. MKS Instruments, Inc. assumes no liability for the customer’s failure to comply with these requirements.

DO NOT SUBSTITUTE PARTS OR MODIFY INSTRUMENT

Do not install substitute parts or perform any unauthorized modification to the instrument. Return the instrument to an MKS Calibration and Service Center for service and repair to ensure that all safety features are maintained.

SERVICE BY QUALIFIED PERSONNEL ONLY

Operating personnel must not remove instrument covers. Component replacement and internal adjustments must be made by qualified service personnel only.

KEEP AWAY FROM LIVE CIRCUITS

Do not replace components with power cable connected. Under certain conditions, dangerous voltages may exist even with the power cable removed. To avoid injuries, always disconnect power and discharge circuits before touching them.

USE CAUTION WHEN OPERATING WITH HAZARDOUS MATERIALS

If hazardous materials are used, users must take responsibility to observe the proper safety precautions, completely purge the instrument when necessary, and ensure that the material used is compatible with sealing materials.

PURGE THE INSTRUMENT

After installing the unit, or before its removal from a system, be sure to purge the unit completely with a clean dry gas to eliminate all traces of the previously used flow material.

USE PROPER PROCEDURES WHEN PURGING

This instrument must be purged under a ventilation hood, and gloves must be worn to protect personnel. To purge this instrument properly, it must be purged in both the horizontal base down and horizontal base up configurations as defined in SEM spec. Device has trapped volume in pressure sensor where gas which is higher than air but still hazardous can accumulate.

DO NOT OPERATE IN AN EXPLOSIVE ENVIRONMENT

To avoid explosion, do not operate this product in an explosive environment unless it has been specifically certified for such operation.

USE PROPER FITTINGS AND TIGHTENING PROCEDURES

All instrument fittings must be consistent with instrument specifications, and compatible with the intended use of the instrument. Assemble and tighten fittings according to manufacturer's directions.

CHECK FOR LEAK-TIGHT FITTINGS

Before proceeding to instrument setup, carefully check all plumbing connections to the instrument to ensure leak-tight installation.

OPERATE AT SAFE INLET PRESSURES

This unit should never be operated at pressures higher than the rated maximum pressure (refer to the product specifications for the maximum allowable pressure).

INSTALL A SUITABLE BURST DISC

When operating from a pressurized gas source, a suitable burst disc should be installed in the vacuum system to prevent system explosion should the system pressure rise.

KEEP THE UNIT FREE OF CONTAMINANTS

Do not allow contaminants of any kind to enter the unit before or during use. Contamination such as dust, dirt, lint, glass chips, and metal chips may permanently damage the unit.

ALLOW PROPER WARM UP TIME FOR TEMPERATURE-CONTROLLED UNITS

Temperature-controlled unit will only meet specifications when sufficient time is allowed for the unit to meet, and stabilize at, the designed operating temperature. Do not zero or calibrate the unit until the warm up is complete.

2.2 Sicherheitshinweise für das Massenflussgerät

2.2.1 In dieser Betriebsanleitung vorkommende Symbole ual

Bedeutung der mit WARNUNG!, VORSICHT! und HINWEIS gekennzeichneten Absätze in dieser Betriebsanleitung.

HINWEIS

Das Symbol HINWEIS macht auf wichtige Informationen bezüglich eines Arbeitsablaufs, einer Arbeitsweise, eines Zustands oder einer sonstige Gegebenheit aufmerksam.

VORSICHT





Das Symbol VORSICHT! weist auf eine Gefahr für das Gerät hin. Es macht auf einen Bedienungsablauf, eine Arbeitsweise oder eine sonstige Gegebenheit aufmerksam, deren unsachgemäße Ausführung bzw. ungenügende Berücksichtigung zu einer Beschädigung oder Zerstörung des Gerätes oder von Teilen des Gerätes führen kann.









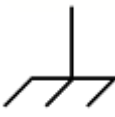

WARNUNG!

Das Symbol WARNUNG! weist auf eine Gefahr für das Bedienpersonal hin. Es macht auf einen Arbeitsablauf, eine Arbeitsweise, einen Zustand oder eine sonstige Gegebenheit aufmerksam, deren unsachgemäße Ausführung bzw. ungenügende Berücksichtigung zu Verletzungen führen kann.

2.2.2 Erklärung der am Gerät angebrachten Symbole

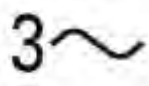
Nachstehender Tabelle sind die Bedeutungen der Symbole zu entnehmen, die am Gerät angebracht sein können.

			
Ein (Energie) IEC 417, No.5007	Aus (Energie)) IEC 417, No.5008	Erdanschluss IEC 417, No.5017	Schutzleiteranschluss IEC 417, No.5019

 <p>Masseanschluss IEC 417, No.5020</p>	 <p>Aquipotentialanschluss IEC 417, No 5021</p>	 <p>Gleichstrom IEC 417, No.5031</p>	 <p>Wechselstrom IEC 417, No.5032</p>
 <p>Gleich- oder Wechselstrom IEC 417, No.5019</p>	 <p>Durchgängige doppelte oder verstärkte Isolierung IEC 417, No.5172-a</p>	 <p>Dreileiter-Wechselstrom (Drehstrom) IEC 617-2, No.020206</p>	
 <p>Warnung vor einer Gefahrenstelle (Achtung, Dokumentation beachten) ISO 3864, No.B.3 1</p>	 <p>Warnung vor gefährlicher elektrischer Spannung ISO 3864, No.B.3 6</p>	 <p>Höhere Temperatur an leicht zugänglichen Teilen IEC 417, No.5021</p>	

2.2.3 Sicherheitsvorschriften und Vorsichtsmaßnahmen

Folgende allgemeine Sicherheitsvorschriften sind während allen Betriebsphasen dieses Gerätes zu befolgen. Eine Missachtung der Sicherheitsvorschriften und sonstiger Warnhinweise in dieser Betriebsanleitung verletzt die für dieses Gerät und seine Bedienung geltenden Sicherheitsstandards, und kann die Schutzvorrichtungen an diesem Gerät wirkungslos machen. MKS Instruments, Inc. haftet nicht für Missachtung dieser Sicherheitsvorschriften seitens des Kunden.

NIEMALS TEILE AUSTAUSCHEN ODER ÄNDERUNGEN AM GERÄT VORNEHMEN!

Ersetzen Sie keine Teile mit baugleichen oder ähnlichen Teilen, und nehmen Sie keine eigenmächtigen Änderungen am Gerät vor. Schicken Sie das Gerät zwecks Wartung und Reparatur an den MKS- Kalibrierungs- und -Kundendienst ein. Nur so wird sichergestellt, dass alle Schutzvorrichtungen voll funktionsfähig bleiben.

WARTUNG NUR DURCH QUALIFIZIERTE FACHLEUTE!

Das Auswechseln von Komponenten und das Vornehmen von internen Einstellungen darf nur von qualifizierten Fachleuten durchgeführt werden, niemals vom Bedienpersonal.

VORSICHT VOR STROMFÜHRENDEN LEITUNGEN!

Ersetzen Sie keine Komponente von Geräten, die an Netzstrom angeschlossen sind. Unter Umständen kann gefährliche Spannung auch dann bestehen, wenn das Netzanschlusskabel von der

Stromversorgung entfernt wurde. Um Verletzungen vorzubeugen sollten zuerst alle Geräte von der Stromversorgung getrennt und alle Stromkreisläufe entladen werden.

VORSICHT BEIM ARBEITEN MIT GEFÄHRLICHEN STOFFEN!

Wenn gefährliche Stoffe verwendet werden, muss der Bediener die entsprechenden Sicherheitsvorschriften genauestens einhalten, das Gerät, falls erforderlich, vollständig spülen, sowie sicherstellen, dass der Gefahrstoff die am Gerät verwendeten Materialien, insbesondere Dichtungen, nicht angreift.

SPÜLEN DES GERÄTES MIT GAS!

Nach dem Installieren oder vor dem Ausbau aus einem System muss das Gerät unter Einsatz eines reinen Trockengases vollständig gespült werden, um alle Rückstände des Vorgängermediums zu entfernen.

ANWEISUNGEN ZUM SPÜLEN DES GERÄTES

Das Gerät darf nur unter einer Ablufthaube gespült werden. Schutzhandschuhe sind zu tragen.

GERÄT NICHT ZUSAMMEN MIT EXPLOSIVEN STOFFEN, GASEN ODER DÄMPFEN BENUTZEN!

Um der Gefahr einer Explosion vorzubeugen, darf dieses Gerät niemals zusammen mit (oder in der Nähe von) explosiven Stoffen aller Art eingesetzt werden, sofern es nicht ausdrücklich für diesen Zweck zugelassen ist.

ANWEISUNGEN ZUM INSTALLIEREN DER ARMATUREN!

Alle Anschlussstücke und Armaturenteile müssen mit der Gerätespezifikation übereinstimmen, und mit dem geplanten Einsatz des Gerätes kompatibel sein. Der Einbau, insbesondere das Anziehen und Abdichten, muss gemäß den Anweisungen des Herstellers vorgenommen werden.

VERBINDUNGEN AUF UNDICHTIGKEITEN PRÜFEN!

Überprüfen Sie sorgfältig alle Verbindungen der Vakuumkomponenten auf undichte Stellen.

GERÄT NUR UNTER ZULÄSSIGEN ANSCHLUSSDRÜCKEN BETREIBEN!

Betreiben Sie das Gerät niemals unter Drücken, die den maximal zulässigen Druck (siehe Produktspezifikationen) übersteigen.

GEEIGNETE BERSTSCHEIBE INSTALLIEREN!

Wenn mit einer unter Druck stehenden Gasquelle gearbeitet wird, sollte eine geeignete Berstscheibe in das Vakuumsystem installiert werden, um eine Explosionsgefahr aufgrund von steigendem Systemdruck zu vermeiden.

VERUNREINIGUNGEN IM GERÄT VERMEIDEN!

Stellen Sie sicher, dass Verunreinigungen jeglicher Art weder vor dem Einsatz noch während des Betriebs in das Instrumenteninnere gelangen können. Staub- und Schmutzpartikel, Glassplitter oder Metallspäne können das Gerät dauerhaft beschädigen oder Prozess- und Messwerte verfälschen.

BEI GERÄTEN MIT TEMPERATURKONTROLLE KORREKTE ANWÄRMZEIT EINHALTEN!

Temperaturkontrollierte Geräte arbeiten nur dann gemäß ihrer Spezifikation, wenn genügend Zeit zum Erreichen und Stabilisieren der Betriebstemperatur eingeräumt wird. Kalibrierungen und Nulleinstellungen sollten daher nur nach Abschluss des Anwärmvorgangs durchgeführt werden.

2.3 Informations de sécurité pour appareils de mesure/contrôle de débit massique

2.3.1 Symboles utilisés dans ce manuel d'utilisation

Définitions des indications AVERTISSEMENT, ATTENTION, et REMARQUE utilisées dans ce manuel.

REMARQUE

L'indication REMARQUE signale une information importante. Elle attire l'attention sur une procédure, une pratique, une condition, ou toute autre situation, présentant un intérêt particulier.

ATTENTION

L'indication ATTENTION signale un danger pour l'appareil. Elle attire l'attention sur une procédure d'exploitation, une pratique, ou toute autre situation, présentant un risque de dégât ou de destruction partielle ou totale du produit, en cas d'exécution incorrecte ou de non-respect des consignes.









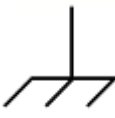

AVERTISSEMENT

L'indication AVERTISSEMENT signale un danger pour le personnel. Elle attire l'attention sur une procédure, une pratique, une condition, ou toute autre situation présentant un risque d'accident pour le personnel, en cas d'exécution incorrecte ou de non-respect des consignes.

2.3.2 Symboles figurant sur l'unité

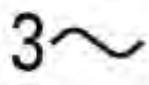
Le tableau suivant décrit les symboles pouvant apparaître sur l'unité.

			
Marche (sous tension) IEC 417, No.5007	Arrêt (hors tension) IEC 417, No.5008	Terre (masse) IEC 417, No.5017	Terre de protection (masse) IEC 417, No.5019

 <p>Masse IEC 417, No.5020</p>	 <p>quipotentialité IEC 417, No.5021</p>	 <p>Courant continu IEC 417, No.5031</p>	 <p>Courant alternatif IEC 417, No.5032</p>
 <p>Courant continu et alternatif IEC 417, No.5019</p>	 <p>Matériel de classe II IEC 417, No.5172-a</p>	 <p>Courant alternatif triphasé IEC 617-2, No.020206</p>	
 <p>Attention : se reporter à la documentation ISO 3864, No.B.3 1</p>	 <p>Attention : risque de choc électrique ISO 3864, No.B.3 6</p>	 <p>Attention : surface brûlante IEC 417, No.5021</p>	

2.3.3 Mesures de sécurité et précautions

Observer les précautions générales de sécurité suivantes pendant toutes les phases d'exploitation de cet appareil. Le non-respect de ces précautions ou des avertissements du manuel constitue une violation des normes de sécurité relatives à l'utilisation de l'appareil et peut compromettre la protection assurée par l'appareil. MKS Instruments, Inc. rejette toute responsabilité en cas de non-respect des consignes par les clients.

PAS DE REMPLACEMENT DE PIÈCES OU DE MODIFICATION DE L'APPAREIL

Ne pas installer de pièces de remplacement ni effectuer des modifications non autorisées sur l'appareil. Renvoyer l'appareil à un centre de service et de calibrage MKS pour tout dépannage ou réparation afin de garantir l'intégrité des dispositifs de sécurité.

DÉPANNAGE UNIQUEMENT PAR DU PERSONNEL QUALIFIÉ

Le personnel d'exploitation ne doit pas essayer de sortir les composants du boîtier ou faire des réglages internes. Le dépannage est réservé au personnel qualifié.

ÉLOIGNEMENT DES CIRCUITS SOUS-TENSION

Ne pas remplacer de composants lorsqu'un câble d'alimentation est branché. Dans certaines conditions, des tensions dangereuses peuvent être présentes même après le retrait du câble d'alimentation. Pour éliminer tout risque de blessure, procéder toujours à la déconnexion et décharger les circuits avant tout contact physique.

PRÉCAUTION EN CAS D'UTILISATION AVEC DES PRODUITS DANGEREUX

Si des produits dangereux sont utilisés, l'utilisateur est responsable du respect des mesures de sécurité appropriées, de la purge complète de l'appareil quand elle s'avère nécessaire, et doit s'assurer que les produits utilisés sont compatibles avec les matériaux d'étanchéité.

PURGE DE L'APPAREIL

Après l'installation de l'unité, ou avant son retrait d'un système, purger l'unité complètement avec un gaz propre et sec afin d'éliminer toute trace du produit de flux utilisé précédemment.

UTILISATION DES PROCÉDURES APPROPRIÉES POUR LA PURGE

Cet appareil doit être purgé sous une hotte de ventilation. Le personnel doit porter des gants de protection.

PAS D'EXPLOITATION DANS UN ENVIRONNEMENT EXPLOSIF

Pour éviter toute explosion, ne pas utiliser cet appareil dans un environnement explosif, sauf en cas d'homologation spécifique pour une telle exploitation.

UTILISATION D'ÉQUIPEMENTS ET PROCÉDURES DE SERRAGE APPROPRIÉS

Tous les équipements de l'appareil doivent être conformes à ses spécifications, et compatibles avec l'utilisation prévue de l'appareil. Assembler et serrer les équipements conformément aux directives du fabricant.

VÉRIFICATION DE L'ÉTANCHÉITÉ DES CONNEXIONS

Vérifier attentivement toutes les connexions des composants pour le vide afin de garantir l'étanchéité de l'installation.

EXPLOITATION AVEC DES PRESSIONS D'ENTRÉE NON DANGEREUSES

Ne jamais utiliser des pressions supérieures à la pression nominale maximum (se reporter aux spécifications de l'unité pour la pression maximum admissible).

INSTALLATION D'UN DISQUE D'ÉCHAPPEMENT ADAPTÉ

En cas d'exploitation avec une source de gaz pressurisé, installer un disque d'échappement adapté dans le système à vide, afin d'éviter une explosion du système en cas d'augmentation de la pression.

MAINTIEN DE L'UNITÉ À L'ABRI DES CONTAMINATIONS

Ne pas laisser des produits contaminants pénétrer dans l'unité avant ou pendant l'utilisation. Des produits contaminants tels que des poussières et des fragments de tissu, de verre et de métal peuvent endommager l'unité de manière permanente.

RESPECT DU TEMPS D'ÉCHAUFFEMENT APPROPRIÉ POUR LES UNITÉS À RÉGULATION DE TEMPÉRATURE

Les unités à régulation de température sont conformes à leurs spécifications uniquement quand on leur laisse un temps suffisant pour atteindre d'une manière stable la température d'exploitation. Ne pas remettre à zéro ou calibrer l'unité tant que l'échauffement n'est pas terminé.

2.4 Medidas de seguridad del dispositivo de flujo de masa

2.4.1 Símbolos usados en este manual de instrucciones

Definiciones de los mensajes de advertencia, precaución y de las notas usados en el manual.

NOTA

El símbolo de notas indica información de importancia. Este símbolo pone de relieve un procedimiento, práctica o condición cuyo conocimiento es esencial destacar.

PRECAUCIÓN









El símbolo de precaución indica la posibilidad de producir daños al equipo. Pone de relieve un procedimiento operativo, práctica, etc. que en caso de no realizarse o cumplirse correctamente puede causar daños o la destrucción total o parcial del equipo.





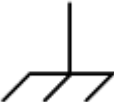

ADVERTENCIA

El símbolo de advertencia indica la posibilidad de que se produzcan daños personales. Pone de relieve un procedimiento, práctica, estado, etc. que en caso de no realizarse o cumplirse correctamente puede causar daños personales.

2.4.2 Símbolos hallados en la unidad

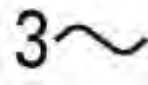
La tabla siguiente contiene los símbolos que puede hallar en la unidad.

 Encendido (alimentación eléctrica) IEC 417, N° 5007	 Apagado (alimentación eléctrica) IEC 417, N° 5008	 Puesta a tierra IEC 417, N° 5017	 Protección a tierra IEC 417, N° 5019
 Caja o chasis IEC 417, N° 5020	 Equipotencialidad IEC 417, N° 5021	 Corriente continua IEC 417, N° 5031	 Corriente alterna IEC 417, N° 5032

 <p>Corriente continua y alterna IEC 417, N° 5019</p>	 <p>Equipo de clase II IEC 417, N° 5172-a</p>	 <p>Corriente alterna trifásica IEC 617-2, N° 020206</p>
 <p>Precaución. Consulte los documentos adjuntos ISO 3864, N° B.3 1</p>	 <p>Precaución. Riesgo de descarga eléctrica ISO 3864, N° B.3 6</p>	 <p>Precaución. Superficie caliente IEC 417, N° 5021</p>

2.4.3 Procedimientos y precauciones de seguridad

Las medidas generales de seguridad descritas a continuación deben observarse durante todas las etapas de funcionamiento del instrumento. La falta de cumplimiento de dichas medidas de seguridad o de las advertencias específicas a las que se hace referencia en otras partes de este manual, constituye una violación de las normas de seguridad establecidas para el uso previsto del instrumento y podría anular la protección proporcionada por el equipo. Si el cliente no cumple dichas precauciones y advertencias, MKS Instruments, Inc. no asume responsabilidad legal alguna.

NO UTILICE PIEZAS NO ORIGINALES O MODIFIQUE EL INSTRUMENTO

No instale piezas que no sean originales ni modifique el instrumento sin autorización. Para asegurar el correcto funcionamiento de todos los dispositivos de seguridad, envíe el instrumento al Centro de servicio y calibración de MKS toda vez que sea necesario repararlo o efectuar tareas de mantenimiento.

LAS REPARACIONES DEBEN SER EFECTUADAS ÚNICAMENTE POR TÉCNICOS AUTORIZADOS

Los operarios no deben retirar las tapas del instrumento. El reemplazo de los componentes y las tareas de ajuste deben ser realizadas únicamente por personal autorizado.

MANTÉNGASE ALEJADO DE LOS CIRCUITOS ACTIVOS

No reemplace componentes con el cable de alimentación eléctrica conectado. En algunos casos, puede haber presente alto voltaje aun con el cable de alimentación eléctrica desconectado. Para evitar lesiones personales, desconecte siempre el cable y descargue los circuitos antes de entrar en contacto con los mismos.

TENGA CUIDADO CUANDO TRABAJE CON MATERIALES TÓXICOS

Cuando se utilicen materiales tóxicos, es responsabilidad de los operarios tomar las medidas de seguridad correspondientes, purgar totalmente el instrumento cuando sea necesario y comprobar que el material utilizado sea compatible con los materiales de sellado.

PURGUE EL INSTRUMENTO

Una vez instalada la unidad o antes de retirarla del sistema, purgue completamente la unidad con gas limpio y seco para eliminar todo resto de la sustancia líquida empleada anteriormente.

USE PROCEDIMIENTOS ADECUADOS PARA REALIZAR LA PURGA

El instrumento debe purgarse debajo de una campana de ventilación y deben utilizarse guantes protectores.

NO HAGA FUNCIONAR EL INSTRUMENTO EN AMBIENTES CON RIESGO DE EXPLOSIÓN

Para evitar que se produzcan explosiones, no haga funcionar este instrumento en un ambiente con riesgo de explosiones, excepto cuando el mismo haya sido certificado específicamente para tal uso.

USE ACCESORIOS ADECUADOS Y REALICE CORRECTAMENTE LOS PROCEDIMIENTOS DE AJUSTE

Todos los accesorios del instrumento deben cumplir las especificaciones del mismo y ser compatibles con el uso que se debe dar al instrumento. Arme y ajuste los accesorios de acuerdo con las instrucciones del fabricante.

COMPRUEBE QUE LOS ACCESORIOS SEAN A PRUEBA DE FUGAS

Antes de proceder con la instalación del instrumento, inspeccione cuidadosamente todas las conexiones de las tuberías para comprobar que hayan sido instaladas a prueba de fugas.

HAGA FUNCIONAR EL INSTRUMENTO CON PRESIONES DE ENTRADA SEGURAS

No haga funcionar nunca el instrumento con presiones superiores a la máxima presión nominal (en las especificaciones del instrumento hallará la presión máxima permitida).

INSTALE UNA CÁPSULA DE SEGURIDAD ADECUADA

Cuando el instrumento funcione con una fuente de gas presurizado, instale una cápsula de seguridad adecuada en el sistema de vacío para evitar que se produzcan explosiones cuando suba la presión del sistema.

MANTENGA LA UNIDAD LIBRE DE CONTAMINANTES

No permita el ingreso de contaminantes en la unidad antes o durante su uso. Los productos contaminantes tales como polvo, suciedad, pelusa, lascas de vidrio o virutas de metal pueden dañar irreparablemente la unidad.

CALIENTE ADECUADAMENTE LAS UNIDADES CONTROLADAS POR MEDIO DE TEMPERATURA

Las unidades controladas por medio de temperatura funcionarán de acuerdo con las especificaciones sólo cuando se las caliente durante el tiempo suficiente para permitir que lleguen y se establezcan a la temperatura de operación indicada. No calibre la unidad y no la ponga en cero hasta que finalice el procedimiento de calentamiento.

2.5 マスフロー機器の安全に関する情報

2.5.1 この取扱説明書で使用されているシンボル

本マニュアルでは警告、注意、ポイントのマークを用いて重要な事項を記載しています。

ポイント

この表示は手順や使用方法、条件などに関する重要な情報が記載されていることを示しています。必ずお読みください。

注意









この表示を無視して誤った取り扱い(手順や使用方法など)をすると、製品が損傷する可能性が想定される内容を示しています。必ずお読みください。

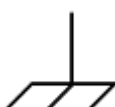

警告

この表示を無視して誤った取り扱い(手順や使用方法、条件など)をすると、人が重傷を負う可能性が想定される内容を示しています。必ずお読みください。

2.5.2 本機器のマーク

以下の表では、本機器に使用されているマークについて説明いたします。

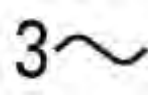
			
オン(電源) IEC 417, No. 5007	オフ(電源) IEC 417, No. 5008	接地(アース) IEC 417, No. 5017	保護接地(アース) IEC 417, No. 5019
			
フレームまたはシャーシ IEC 417, No. 5020	等電位 IEC 417, No. 5021	直流 IEC 417, No. 5031	交流 IEC 417, No. 5032

 <p>直流と交流 IEC 417, No. 5019</p>	 <p>クラス 2 機器 IEC 417, No. 5172-a</p>	 <p>三相交流 IEC 617-2, No. 020206</p>
 <p>注意 (付属書を参照) ISO 3864, No. B.3 1</p>	 <p>注意 (感電の危険あり) ISO 3864, No. B.3 6</p>	 <p>注意 (表面が熱くなっています) IEC 417, No. 5021</p>

2.5.3 安全対策について

本機器を使用する際は、必ず以下の安全対策を守ってください。これらの安全対策や本マニュアルの警告を無視すると、機器本来の用途の安全基準を侵害することになり、機器が提供する保護機能が損なわれる可能性があります。MKS Instruments, Inc. は、顧客側の安全対策の不履行に対しては一切責任を負いかねます。

勝手に部品を変えたり、本体を改造しないこと

本機器に代用部品を使用したり、不正な改造を加えないでください。すべての安全システムを正しく機能させるための修理やメンテナンスが必要な場合は、本機器を MKS Calibration and Service Center まで戻してください。

修理は必ず専門の修理サービスを利用すること

オペレータは絶対に本機器を分解しないでください。部品の交換や内部の調整は必ず専門の修理サービスを利用してください。

電流が通じている回路から切断すること

電源ケーブルを接続したままで部品を交換しないでください。特定の状況では、電源ケーブルを取り外した状態でも危険な電圧が残っている場合があります。感電などの事故を防ぐため、回路に触れる前に必ず電源から切断し、放電してください。

危険な材料を使用する場合は慎重に機器を使用すること

危険な材料を使用する場合は、使用者は各自の責任の元で適切な安全対策を講じてください。必要に応じて本機器を浄化してください。また、使用する材料に対するシーリング材の耐久性を確認してください。

機器を浄化すること

本機器を取り付けた後やシステムから取り外す前に、きれいな乾燥ガスで本機器を浄化し、使用した材料を完全に除去してください。

浄化する場合は適切な手順で行うこと

本機器の浄化は換気フードの下で行う必要があります。また、浄化作業を行う人は必ず手袋を着用してください。

爆発の危険性のある環境で機器を使用しないこと

爆発が起きるのを防ぐため、本機器を爆発の危険性のある環境で使用しないでください。ただし、そのような環境での使用が特別に保証されている場合は除きます。

適切な金具類を使用し、手順に従って金具の締めを行うこと

金具類は本機器の仕様と一致し、機器本来の用途に適合したものである必要があります。金具類の取り付けや締めは、製造業者の指示に従ってください。

液体の漏れがないよう接続箇所を確認すること

本機器を設定する前に、すべての配管の接続を慎重に確認し、液体が漏れないようにしてください。
マスフロー機器の安全に関する情報

安全なインレット圧力で使用すること

定格の最大圧力を超える圧力の下で本機器を絶対に使用しないでください (最大許容圧力については仕様書を参照)。

適切なバーストディスクを取り付けること

圧力のかかったガスを使用する場合は、万一システムが爆発した場合にシステムの圧力が上昇するのを防ぐため、真空システムに適切なバーストディスクを取り付けてください。

本機器に異物やゴミが混入しないようにすること

本機器の使用前または使用中に、ほこりやゴミ、繊維、ガラスの破片、金属片などの異物やゴミが混入しないようにしてください。本機器が損傷する可能性があります。

温度調整された機器を十分に温めてから使用すること

温度調整された機器が適切な作動温度にならないうちに使用すると、仕様通りの動作をしないことがあります。本機器が十分に温まるまでは目盛りをゼロに合わせたり、較正しないでください

2.6 질량 유량 장치 안전 정보

2.6.1 본 지침 매뉴얼에 사용되는 기호들

매뉴얼 전체에 사용되는 경고, 주의 및 참고 메시지의 정의.

참고

この表示は手順や使用方法、条件などに関する重要な情報が記載されていることを示しています。必ずお読みください。

注意

この表示を無視して誤った取り扱い(手順や使用方法など)をすると、製品が損傷する可能性が想定される内容を示しています。必ずお読みください。







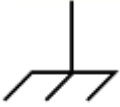

경고

경고 표시는 위험을 나타냅니다. 이 표시는 올바르게 수행되거나 지켜지지 않을 경우, 사람에게 상해를 입힐 수 있는 절차, 수행지침, 상태 또는 이와 유사한 상황들에 대한 주의를 환기시킵니다.

2.6.2 장치에 표시된 기호들

다음 표는 장치에서 볼 수 있는 기호들을 설명합니다.

			
컴 (전원) IEC 417, No. 5007	콤 (전원) IEC 417, No. 5008	접지(지면) IEC 417, No. 5017	보호 접지(지면) IEC 417, No. 5019

 프레임 또는 새시 IEC 417, No. 5020	 등전위성 IEC 417, No. 5021	 직류 IEC 417, No. 5031	 교류 IEC 417, No. 5032
 직류와 교류 모두 IEC 417, No. 5019	 클래스 II 장비 IEC 417, No. 5172-a	 3상 교류 IEC 617-2, No. 020206	
 주의 (동봉 문서 참조) ISO 3864, No. B.3 1	 주의, 감전 위험 ISO 3864, No. B.3 6	 주의, 표면이 뜨거움 IEC 417, No. 5021	

2.6.3 안전 절차 및 예방조치

본 기계의 모든 작동 시에 다음의 일반 안전 예방조치를 준수하십시오. 아래 예방조치를 준수하지 않거나 본 매뉴얼의 다른 부분에 있는 특정 경고를 준수하지 않을 경우, 기계 사용 목적의 안전 기준을 위반하는 것이 되며, 장비가 제공하는 보호기능을 손상시킬 수 있습니다. MKS Instruments, Inc.는 고객이 본 요건을 준수하지 않는 경우에 대해서는 어떠한 책임도 지지 않습니다.

부품을 교체하거나 기계를 개조하지 마십시오

교체 부품을 설치하거나 기계에 허가되지 않은 어떠한 수정도 가하지 마십시오. 서비스와 수리가 필요한 경우에는 모든 안전 특성이 유지되도록 기계를 MKS 보정 서비스 센터(MKS Calibration and Service Center)로 보내주십시오.

자격이 있는 사람에게만 서비스를 받으십시오

작동하는 사람은 기계 겉면을 제거해서는 안됩니다. 부품 교체 및 내부 조정은 자격이 있는 서비스 기사에게만 받으실 수 있습니다.

전류가 통하는 회로에서 분리해 보관하십시오

전원 케이블을 연결한 채로 부품을 교체하지 마십시오. 일부 환경에서는 전원 케이블을 제거한 상태라도 위험 전압이 존재할 수 있습니다. 부상을 방지하려면, 전원을 항상 분리하고 회로를 만지기 전에 회로를 방전시키십시오.

위험한 물질과 함께 작동할 때는 주의를 기울이십시오

위험한 물질이 사용되는 경우, 사용자는 필요시 기계를 완전히 청소하여, 적절한 안전 예방조치를 준수할 책임을 지키고, 사용된 물질이 봉인 물질과 함께 사용해도 무방하다고 보증할 수 있어야 합니다.

기계를 청소하십시오

장치를 설치한 후나 시스템에서 장치를 제거하기 전에는 반드시 깨끗한 건조성 기체로 장치를 완전히 청소하여 이전에 사용된 유량 물질의 모든 흔적을 제거하십시오.

청소 시에는 적절한 절차를 사용하십시오

본 기계는 환기 후드 아래에서 청소되어야 하며, 인체 보호를 위해 장갑을 착용해야 합니다.

폭발성 환경에서 작동하지 마십시오

폭발을 방지하려면, 폭발성 환경에서 작동하도록 특별히 승인받지 않은 경우 본 제품을 폭발성 환경에서 작동하지 마십시오.

적절한 조립부품과 조임 절차를 사용하십시오

모든 기계 조립부품은 제품 사양과 일치해야 하고, 기계의 사용 목적에 부합해야 합니다. 제조업체의 지시에 따라 조립부품을 조립하고 조이십시오.

누출방지 조립부품을 점검하십시오

기계 설치를 진행하기 전에 기계의 모든 연관 연결부를 점검해 누출방지 설치가 되었는지 확인하십시오.

안전한 흡입 압력에서 작동하십시오

이 장치는 절대 정격 최대 압력보다 높은 압력에서 작동해서는 안 됩니다(최대 허용 압력에 대해서는 제품 사양을 참조하십시오).

적합한 안전 파열판을 설치하십시오

가압 가스 공급원에서 작동시, 시스템 폭발이 시스템 압력 상승을 일으키는 것을 방지하기 위해 적합한 안전 파열판이 진공 시스템에 설치되어야 합니다.

장치를 오염이 없는 곳에 보관하십시오

장치를 사용하기 전이나 사용 중에는 어떠한 종류의 오염 물질도 허용해서는 안됩니다. 먼지, 때, 보풀, 유리 조각, 금속 조각과 같은 오염 물질은 영구적으로 장치를 손상시킬 수 있습니다.

온도 제어 장치의 경우 알맞은 시동 시간을 두십시오

온도 제어 장치는 장치가 설계 작동 온도와 일치하고 이 온도에서 안정화될 수 있도록 충분한 시간을 허용해야만 사양에 맞게 작동합니다. 시동이 완료될 때까지 장치를 영점 설정하거나 보정하지 마십시오.

3 Overview

The MKS G and I Series family of thermal based mass flow controller (MFC) technologies represents state of the art MFC technology in a cost effective, reliable, and versatile design platform that allows for easy integration into new applications. Advances in the three major design components of the traditional thermal based MFC (flow sensor, by-pass, and control valve) combined with an enhanced feedback control algorithm have yielded improvements in performance and accuracy for the multi-gas/multi-range G and I Series MFCs. Features that are common to the G and I product lines are:

- Fast flow control settling times for set point startup and during process step changes.
- External communications port that allows users to access the embedded software to verify MFC functionality or change MFC flow conditions without removing from its installation location.
- Multi-gas, multi-range availability in the embedded software that allows immediate reconfiguration of the MFC for changing process requirements, minimizing inventory for a variety of process conditions.

Enhanced I series environmental design features include:

- IP66 design for severe moisture and dust protection in severe process environments.



Figure 1: MFCs G and I Series

3.1 Product Support Documents

Product support documents and additional detailed information about various I/O specifications can be found on the MKS web site for the G and I Series MFC products. These documents include:

- MFC data sheets
- Quick start guides to establish communication to the device over TCP/IP for MFC configuration
- Step files
- DeviceNet specification
- Profibus specification
- RS 485 communication specification
- Ethercat specification
- Profinet specification

3.2 Manual References

The documents listed below are referenced throughout this manual.

- [1] “DeviceNet Specification, Volume I: DeviceNet Communication Model and Protocol”, Open DeviceNet Vendors Association, Inc. Release 2.0. ERRATA 4.0
- [2] “DeviceNet Specification, Volume II: DeviceNet Profiles and Object Library”, Open DeviceNet Vendors Association, Inc. Release 2.0. ERRATA 4.0
- [3] “Sensor/Actuator Network Common Device Model”, SEMI Standards Document E54.1-0097.
- [4] “Sensor/Actuator Network Communications Standard for DeviceNet”, SEMI Standards Draft Document E54.4-0097.
- [5] “Sensor/Actuator Network Specific Device Model for Mass Flow Devices”, SEMI Standards Draft Document #2253C.
- [6] “Sensor/Actuator Network Standard”, SEMI Standards Document E54-0097.
- [7] SEMI E17-00-0060 Guideline for Mass Flow Controller Transient Characteristics Tests
- [8] SEMI E18-00-0091. Guideline for Temperature Specifications of the Mass Flow Controller
- [9] SEMI E27-00-0092. Standard for Mass Flow Controller and Mass Flow Meter Linearity
- [10] SEMI E28-00-0092. Guideline for Pressure Specifications of the Mass Flow Controller
- [11] SEMI E56-00-1296. Test Method for Determining Accuracy, Linearity, Repeatability, Short Term Reproducibility, Hysteresis, and Dead Band of Thermal Mass Flow Controllers
- [12] SEMI Standards Document E52-95.

- [13] SEMI E80-00-0299. Test Method Determining Attitude Sensitivity of Mass Flow Controllers
- [14] SEMI Standards Document E52-95. Practice for Referencing Gases and Gas Mixtures Used in Digital Mass Flow Controllers
- [15] Instruction Manual, G / I-Series MFC, RS845 Supplement
- [16] Instruction Manual, G / I-Series MFC, DeviceNet Supplement
- [17] Instruction Manual, G / 1 -Series MFC, Profibus Supplement
- [18] Modbus Communications Supplement
- [19] Ethercat Supplement
- [20] Profinet Supplement

3.3 Product Description Guide

Table 1: G Series MFC

G Series Model	MFC Seal	Flow Range (sccm)	Multi-Gas/Multi-Range	Design Features	Applications
GE50A	E lastomer Sealed	10-50000	Model based gas table. Able to re-range the MFC 40 to 60% depending on bin size.	Standard 1.5" form factor. Wetted surfaced 316 SS with 16 Ra surface finish. One elastomer O-ring. Wide range of analog and digital I/Os.	Designed for use with inert, non-toxic/non-corrosive gases.
GM50A	M etal Sealed	10-50000	Model based gas table. Able to re-range the MFC 40 to 60% depending on bin size.	Standard 1.5" form factor. Wetted surfaced 316 SS with 10 Ra surface finish. Wide range of analog and digital I/Os.	Designed to be compatible with all gases.

G Series Model	MFC Seal	Flow Range (sccm)	Multi-Gas/Multi-Range	Design Features	Applications
GV50A	Elastomer Sealed / Designed with an integral positive Shut-off Valve	10-50000	Model based gas table. Able to re-range the MFC 40 to 60% depending on bin size.	Standard 1.5" form factor. Wetted surfaced 316 SS with 16 Ra surface finish. One elastomer O-ring. Wide range of analog and digital I/Os.	Designed for use with inert, non-toxic/non-corrosive gases.
GM51A	Metal Sealed	10-50000	Model based gas table. Able to re-range the MFC 40 to 60% depending on bin size.	Standard 1.125" form factor, compatible with tight gas panel designs. Wetted surfaced 316 SS with 10 Ra surface finish. Wide range of analog and digital I/Os.	Designed to be compatible with all gases.
GM100A	Metal Sealed	1000000	Model based gas table. Able to re-range the MFC 50%.	Standard 1.5" form factor, compatible with tight gas panel designs. Wetted surfaced 316 SS with 10 Ra surface finish. Wide range of analog and digital I/Os.	Designed to be compatible with all gases.

Table 2: I Series MFC

I Series Model	MFC Seal	Flow Range (sccm)	Multi-Gas/Multi-Range	Design Features	Applications
IE 50A	E lastomer Sealed	10-50000	Model based gas table. Able to re-range the MFC 40 to 60% depending on bin size.	Standard 1.5" form factor. Wetted surfaced 316 SS with 16 Ra surface finish. One elastomer O-ring. Wide range of analog and digital I/Os. IP 66 rating for severe environmental conditions.	General industrial applications. Designed for use with inert, non-toxic/non-corrosive gases.
IM 50A	M etal Sealed	10-50000	Model based gas table. Able to re-range the MFC 40 to 60% depending on bin size.	Standard 1.5" form factor. Wetted surfaced 316 SS with 10 Ra surface finish. Wide range of analog and digital I/Os. IP 66 rating for severe environmental conditions.	Industrial applications where external environmental factors influence performance. Designed to be compatible with all gases.

3.4 General MFC Overview and Features

3.4.1 Performance

G and I series mass flow controller technology has brought together a combination of patented flow sensor technology and high speed single processor digital architecture to provide control feedback to a fast response solenoid valve design. The result of this design effort is to provide an MFC with a typical flow control response time less than 750 milliseconds over a wide dynamic control range from 5 to 100% Full Scale (FS) of the device. For time critical flow transitions the flow control response of the G and I series MFC can be tailored exactly to the required process steps with easily configured ramp and set point delay functions available in the embedded MFC Browser Interface.

3.4.2 Multi Gas and Multi-Range Functions

The latest generation two-element sensing circuit provides accurate, repeatable performance even in low flow ranges (< 10 sccm). Understanding the physics of the active flow path (sensor and bypass) has resulted in the development of a model based multi-gas algorithm that is more accurate for both

linear and non-linear process gases as compared to the application of the traditional linear Gas Correction Factor (GCF). New gas tables can be immediately created on board the MFC from a list with new calibration tables for the selected gas being derived from a single accurate N2 manufacturing calibration gas table created using NIST traceable primary standards. Once selected from the Browser Interface, the new gas table can be re-scaled based upon the automatically defined N2 equivalent minimum and maximum flow values without affecting:

- New gas table accuracy
- Control range of the MFC (2% to 100% FS)
- Closed conductance leak integrity of the control valve (.2% FS for the selected gas table)

3.4.3 User Interface and MFC Diagnostics

All of the G and I Series models have an external LAN port on the side of the MFC body. Connecting the host computer or a remote laptop to this port using a standard Ethernet cable gives the user the ability to open and use the embedded browser to:

- Configure the device for users application
 - Change and create gases from the extensive gas table list
 - Set the full scale flow and flow units
 - Execute a flow zero function to re-zero the sensor
 - Set ramp rates or delay times for the set point to optimize process steps
- Upgrade in the field as new features are added to MFC
 - Upload updated firmware and new gas tables directly to the MFC
- Diagnose and troubleshoot MFC issues before removing the MFC from service
 - Utilize the plot page to graph key MFC variables at data rates up to 100 Hz

3.4.4 MFC Reliability

G and I Series MFC designs utilize a low mechanical and electronic components count in an effort to ensure the reliability of the device.

Mechanical and electrical “stress” tests have been used by the engineering design team including:

- STRIFE, including temperature cycling and vibration (sine and random tests)
- EMC Directive 2004/108/EC for CE Mark compliance (with a metal braided, shielded cable, properly grounded at both ends)

DeviceNet hardware and software compliance testing includes:

- ODVA Compliance Certification

NOTE

All MFC Models are RoHS compliant designs.

3.5 MFC Cleanliness

The mechanical design of the G and I Series MFC has been engineered to minimize internal wetted surface area and virtual leaks allowing rapid dry-down during purge process steps. All MFC wetted surfaces go through an MKS proprietary cleaning process making them compatible for O₂ service.

Elastomer sealed MFC models have a machined 16 Ra surface finish, while the metal sealed MFC models are manufactured with a precision machined 10 Ra max surface finish and electro-polished wetted surfaces to enhance the cleanliness of the GM and IM models.

A variety of internal valve plug materials are available for the elastomer sealed GE and IE models. Selection of plug material is dependent on the type of gas to which the MFC will be exposed during operation. The internal valve control plug of the metal sealed GM and IM MFCs is Teflon due to its chemical stability and other materials properties such as low outgassing and particle generation from the precision polished plug.

3.6 Specifications

Table 3: General Performance and Design Specification

Model and Specification	MFCA	MFCA	MFCMA
Performance			
Full Scale Flow (N ₂ equivalent)	10-50000 sccm	10-50000 sccm	100000 sccm
Accuracy	± 1% of setpoint for > 20 to 100% F.S.	± 1% of setpoint for > 20 to 100% F.S.	± 1% of setpoint for > 20 to 100% F.S.
	± 0.2% of FS for 2 to 20% F.S.	± 0.2% of FS for 2 to 20% F.S.	± 0.2% of FS for 2 to 20% F.S.
Control Range	2% to 100% of F.S.	2% to 100% of F.S.	2% to 100% of F.S.
Typical Controller Settling Time (per SEMI Guideline E17-0600)	~ 750 milliseconds (typical above 5% F.S.)	~ 750 milliseconds (typical above 5% F.S.)	~ 750 milliseconds (typical above 10% F.S.)

Model and Specification	MFCA	MFCA	MFCMA
Repeatability	± 0.3% of Reading	± 0.3% of Reading	± 0.3% of Reading
Resolution	0.1% of Full Scale	0.1% of Full Scale	0.1% of Full Scale
Operation Ratings			
Normal Operating Pressure Differential (with atmospheric pressure at the MFC outlet)	10 to 5000 sccm: 10 to 40 psid	10 to 5000 sccm: 10 to 40 psid	50000 - 100000 sccm: 40 to 80 psid
	10000 to 20000 sccm: 15 to 40 psid	10000 to 20000 sccm: 15 to 40 psid	
	30000 to 50000 sccm: 25 to 40 psid	30000 to 50000 sccm: 25 to 40 psid	
Proof Pressure	1000 psig	1000 psig	1000 psig
Burst Pressure	1500 psig	1500 psig	1500 psig
Temperature Coefficients			
Zero	<0.05% F.S./°C	<0.05% F.S./°C	<0.05% F.S./°C
Span	<0.08% Reading/°C	<0.08% Reading/°C	<0.08% Reading/°C
Inlet Pressure Coefficient	< 0.02% of Reading./psi	< 0.02% of Reading./psi	< 0.02% of Reading./psi
Warm-Up Time	< 30 min	< 30 min	< 30 min
Normal Operating Temperature Range	10°C to 50°C	10°C to 50°C	10°C to 50°C
Storage Humidity	0 to 95% Relative Humidity, non-condensing	0 to 95% Relative Humidity, non-condensing	0 to 95% Relative Humidity, non-condensing
Storage Temperature	-20°C to 65°C (-4°F to 149°F)	-20°C to 65°C (-4°F to 149°F)	-20°C to 65°C (-4°F to 149°F)
ROHS Compliant	Yes	Yes	Yes

Model and Specification	MFCA	MFCA	MFCMA
Electromagnetic Compatibility	CE Compliant 2004/108/EC	CE Compliant 2004/108/EC	CE Compliant 2004/108/EC

Table 4: Electrical Specification

I/O Type	Electrical Connections	MFC Connector Design	Power Supply and Consumption
Analog	9 pin / 15 pin Male D sub	Power and Device Control	+15- 24V, < 4 Watts
RS 485	9 pin Male D sub	Power and Digital Communication	+15- 24V, < 4 Watts
DeviceNet	5 pin Male Trunkline Connector	Power and Digital Communication	+11- 24V, < 4 Watts
Profibus	1 9 pin Female D sub (communication) 1 9 pin Male D sub (power)	Power and Digital Communication	+15- 24V, < 4 Watts
Ethercat	5 pin M8 Connector	Power only	+24 V (+/-10%), < 5 Watts
Profinet	5 pin M8 Connector	Power only	+24 V (+/-10%), < 5 Watts

Table 5: Mechanical and Material Specification

	GE50A, GV50A. IE50A – Elastomer Sealed	GM50A, IM50A – Metal Sealed	GM100A - Metal Sealed	GM51A - Metal Sealed
Valve Type	Normally Closed / Normally open / No valve (Meter only)			
Leak Integrity				
External (scc/sec He)	< 1 x 10 ⁻⁹	< 1 x 10 ⁻¹⁰	< 1 x 10 ⁻¹⁰	< 1 x 10 ⁻¹⁰

	GE50A, GV50A. IE50A – Elastomer Sealed	GM50A, IM50A – Metal Sealed	GM100A - Metal Sealed	GM51A - Metal Sealed
Through closed valve	< 10K Valve - < 0.1% for F.S. at 40 psig inlet to atm > 10K Valve - < 1% FS @ 40 psig inlet to atm	< 1% for F.S. at 40 psig inlet to atm	< 1% for F.S. at 40 psig inlet to atm	< 1% for F.S. at 40 psig inlet to atm
Through shut-off valve	<4x 10-09 atm-cc/sec He (GV50A model only)	Not Applicable	Not Applicable	Not Applicable
Wetted Materials				
Standard	316L S.S. VAR (equivalent to 316 S.S. SCQ for semiconductor quality), 316 S.S., Elgiloy, Nickel	316L S.S. VAR (equivalent to 316 S.S. SCQ for semiconductor quality), 316 S.S., Elgiloy, KM-45	316L S.S. VAR (equivalent to 316 S.S. SCQ for semiconductor quality), 316 S.S., Elgiloy, KM-45	316L S.S. VAR (equivalent to 316 S.S. SCQ for semiconductor quality), 316 S.S., Elgiloy, KM-45
Seals and Valve Seat	Viton, Buna, Neoprene, EPDM, Kalrez	SS / PTFE	SS / Viton, Buna, Neoprene, EPDM, Kalrez	SS / PTFE
Surface Finish	16 μin Ra	10 μin Ra, Electropolished	10 μin Ra, Electropolished	10 μin Ra, Electropolished
Weight	≤ 3 lbs (1.4 kg)	≤ 3 lbs (1.4 kg)	≤ 3 lbs (1.4 kg)	≤ 3 lbs (1.4 kg)

3.7 Mechanical Dimensions

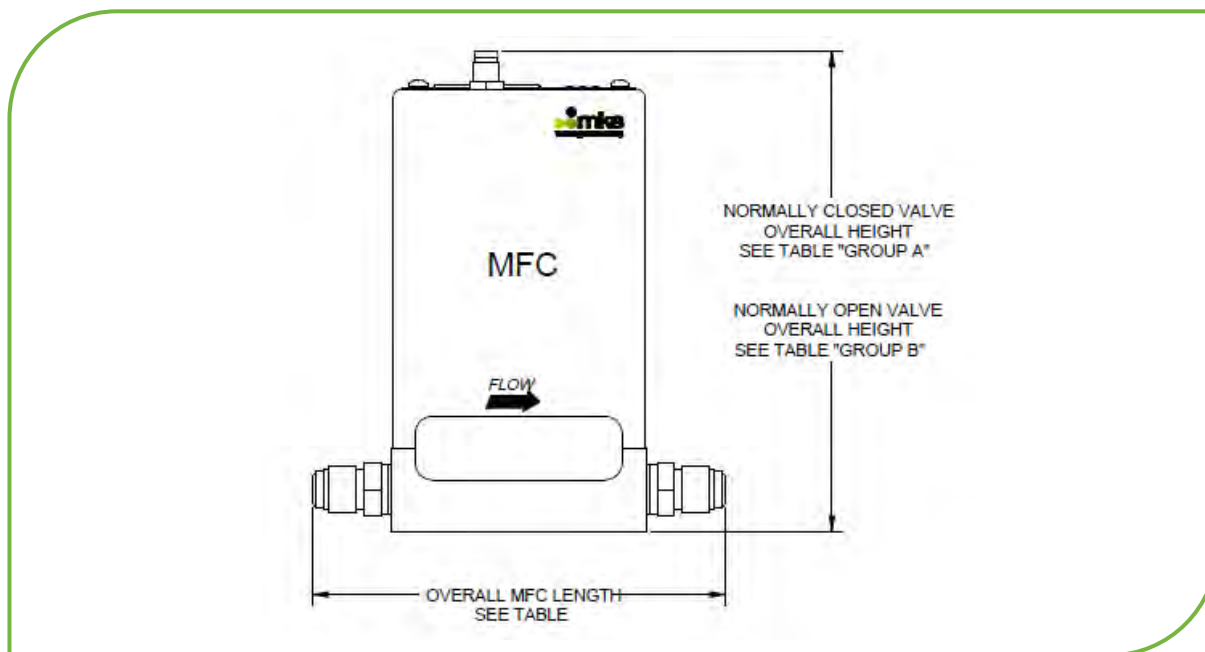

Figure 2: MFC Mechanical Dimensions

Table 6: Fitting Design and MFC Length

Fitting Design	MFC Length (inches / mm)	
Swaglok 4 VCR Male	4.88	124
Swaglok 8 VCR Male	5.28	134.1
1/8" Swaglok	4.44	112.8
1/4" Swaglok	4.44	112.8
3/8" Swaglok	4.72	120
1/2" Swaglok	4.72	120
6 mm	4.44	112.8
8 mm	4.72	120
10 mm	4.72	120

Fitting Design	MFC Length (inches / mm)	
	12 mm	4.72
C Seal Surface Mount	4.14	105.2
W Seal Surface Mount	4.14	105.2
4 VCO Male	4.56	115.8
8 VCO Male	4.9	124.5
KF 16	4.88	124

Table 7: Elastomer Sealed MFC Model Height Dimensions

G and I Series Height Dimensions for Elastomer Sealed MFC Models						
MFC Model		I/O	MFC Height - Group A (inches / mm)		MFC Height Group B (inches / mm)	
GE50A	GM50A	15 pin D sub	5.49	139.4	6.12	155.4
		9 pin D sub	5.49	139.4	6.12	155.4
		15 pin 4-20mA	5.49	139.4	6.12	155.4
		RS 485	5.49	139.4	6.12	155.4
		DeviceNet	5.65	143.6	6.26	159
		Profibus	5.49	139.4	6.12	155.4
		Ethercat	5.69	144.5	6.32	160.6
		Profinet	5.69	144.5	6.32	160.6

G and I Series Height Dimensions for Elastomer Sealed MFC Models						
MFC Model		I/O	MFC Height - Group A (inches / mm)		MFC Height Group B (inches / mm)	
IE50A	IM50A	15 pin D sub	5.64	143.2	6.26	159

G and I Series Height Dimensions for Elastomer Sealed MFC Models

MFC Model	I/O	MFC Height - Group A (inches / mm)		MFC Height Group B (inches / mm)	
	9 pin D sub	N/A	N/A	N/A	N/A
	15 pin 4-20mA	5.64	143.2	6.26	159
	RS485	N/A	N/A	N/A	N/A
	DeviceNet	N/A	N/A	N/A	N/A
	Profibus	5.64	143.2	6.26	159
	Ethercat	N/A	N/A	N/A	N/A
	Profinet	N/A	N/A	N/A	N/A
GV50A	15 pin D sub	5.61	142.5	N/A	N/A
	9 pin D sub	5.61	142.5	N/A	N/A
	15 pin 4-20mA	5.61	142.5	N/A	N/A
	RS 485	5.61	142.5	N/A	N/A
	DeviceNet	5.78	146.8	N/A	N/A
	Profibus	5.63	143	N/A	N/A
	Ethercat	5.82	147.7	N/A	N/A
	Profinet	5.82	147.7	N/A	N/A

G and I Series Height Dimensions for Elastomer Sealed MFC Models

MFC Model	I/O	MFC Height - Group A (inches / mm)		MFC Height Group B (inches / mm)	
GM51A	15 pin D sub	5.48	139.2	N/A	N/A
	9 pin D sub	5.48	139.2	N/A	N/A

G and I Series Height Dimensions for Elastomer Sealed MFC Models

MFC Model	I/O	MFC Height - Group A (inches / mm)		MFC Height Group B (inches / mm)	
	DeviceNet	5.66	143.8	N/A	N/A
	RS485	5.49	139.4	N/A	N/A
	Ethercat	5.68	144.2	N/A	N/A
	Profinet	5.68	144.2	N/A	N/A
GM100A	15 pin D sub	5.58	141.8	N/A	N/A
	9 pin D sub	5.58	141.8	N/A	N/A
	15 pin 4-20mA	5.58	141.8	N/A	N/A
	RS-485	5.58	141.8	N/A	N/A
	DeviceNet	5.79	147	N/A	N/A
	Profibus	5.58	141.8	N/A	N/A
	Ethercat	5.77	146.6	N/A	N/A
	Profinet	5.77	146.6	N/A	N/A

4 Installation and MFC Setup

This chapter describes techniques and details on how to properly handle a newly acquired G or I series MFC in an effort to prepare the gas system and the MFC for a safe and clean installation. Installation process steps described are:

- Considering the MFC Installation Environment, below
- Unpacking the MFC in a Clean Environment, page 46
- Mounting Hardware for Installing the MFC, page 47
- Checking the Leak Tight Seal for the MFC, page 49
- Applying Power and Signal Cables to the MFC, page 49
- Leak Checking the MFC Installation, page 54
- Setting Up and Configuring the MFC, page 59
- Zeroing the MFC, page 60

NOTE

All documented procedures for installation and safety checks for installation of a new MFC by the end user supersede any procedural recommendations by MKS Instruments in this manual.

4.1 Considering the MFC Installation Environment

4.1.1 MFC Installation Environment

The area around where the MFC is installed should have adequate ventilation and control of the ambient humidity and temperature to meet the suggested manufacturing specification for proper operating temperatures between 10°C and 50°C.

Careful consideration should be given to the design of the installation to minimize any shock and vibration during actual operation while still allowing the user:

- Easy access to control switches and communication ports available on the top and sides of the MFC
- Ability to purge and remove the device should the device require servicing

Installation of an upstream particle filter is recommended to help protect the flow sensor and valve area from potential foreign material entering the MFC during operation and adversely affecting the performance of the instrument.

Note that the control valve of the MFC is not designed to be a shut off valve and the MFC has an acceptable closed conductance leak specification across the valve when the MFC is idle. It is highly recommended that positive pneumatic shut off valves be installed on the inlet and outlet of the MFC to

properly isolate the MFC when it is idle. These types of valves also provide the means to execute a recommended proper zero routine when required by the process.

4.2 Pre-Installation Safety Considerations

Safety is the paramount consideration while installing the MFC so it is necessary to make sure all gas lines have been purged with high purity, dry Nitrogen or other high purity dry inert gas to ensure that the lines are free of potentially harmful gases (toxic, flammable), organic contaminants, moisture, and oxygen.

WARNING

PERSONAL SAFETY HAZARDS!

Gas systems can contain toxic, explosive, combustible, corrosive or other gases that can present life-threatening hazards.

ALWAYS use appropriate personal protection equipment.

NEVER open a gas line unless the system has been properly purged of harmful gases.

Certain gas system components may contain hazardous residuals if not properly prepared. Consult with your facility safety engineers prior to working on any gas delivery system and notify all personnel in adjacent areas to take appropriate personal safety precautions BEFORE working on the equipment.

4.3 Unpacking the MFC in a Clean Environment

Each device is built and leak tested with helium in a cleanroom environment. The instrument is double-packaged using vacuum to ensure maintenance of its particle-free condition during shipment.

To maintain the integrity of the manufacturing MFC packaging procedures, follow clean room protocols while removing the device from the second vacuum sealed bag. Inside the second sealed bag is the Calibration Certificate for your records and traceability. This official document summarizes the MFC accuracy of the N₂ manufacturing calibration utilizing NIST traceable primary standards.

Remove the MFC out of the cleanroom sealed bag, carefully inspect the MFC for any sign of mechanical damage to the enclosure, gas connector fittings, electrical connectors, etc. If damage is noted on the MFC, notify your carrier and MKS Service immediately. If the MFC needs to be returned to MKS for repair, two forms must be completed:

- RMA Request Form to properly document the reason for return. This form is available on the MKS web site at: <http://www.mksinst.com/service/serviceeraform.aspx>

- Health and Safety Form to ensure the safety of handling the MFC once it is in a MKS Service Center. This form is available on the MKS web site at:
<http://www.mksinst.com/service/HealthAndSafetyForms.aspx>

Once MKS Service receives the completed forms, we will provide an RMA number and contact details for shipping the device back to MKS.

4.4 Mounting Hardware for Installing the MFC

The G and I MFC stainless steel bodies are designed with in-line fittings or with a down mount designed C seal or W seal (model dependent) that are used to secure the MFC in a gas panel location.

A summary of the fitting types by model and mounting pattern hardware are shown in Table 8 and , and dimensional drawings are shown in Figures 3 and 4.

Table 8: Mounting Pattern Hardware: Fitting Types by Model

MFC Model	Fitting Design	Mounting Pattern Hardware
GM50A / IM50A	In-Line VCR / Compression	2 - # 8/32 UNC2B, 2-M4
	Down Mount C / W Seal	4 - M5 - .8 x 30 mm long
GE50A / IE50A	In-Line VCR / Compression	2 - # 8/32 UNC2B, 2-M4
GM51A	In-Line VCR / Compression	4 - # 8/32 UNC2B, 2-M4
	Down Mount C / W Seal	4 - M4 - .7 x 30 mm long
GM100A	In-Line VCR / Compression	2 - # 8/32 UNC2B, 2-M4
	Down Mount C / W Seal	4 - M5 - .8 x 30 mm lo
GV50A	In-Line VCR / Compression	Pre-mounts base plate with slots

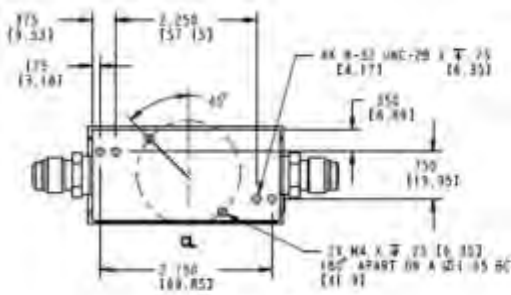

GM50A / IM50A

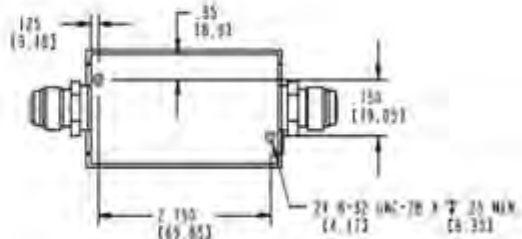

GE50A / IE50A

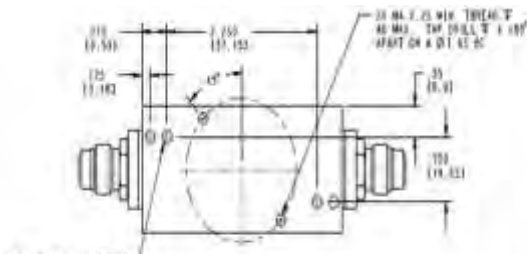

GM100A

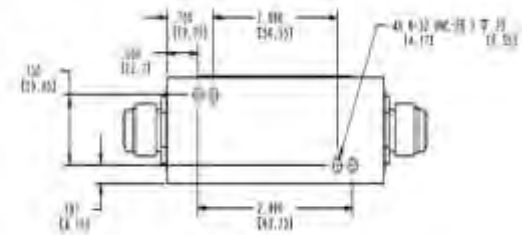

GM51A

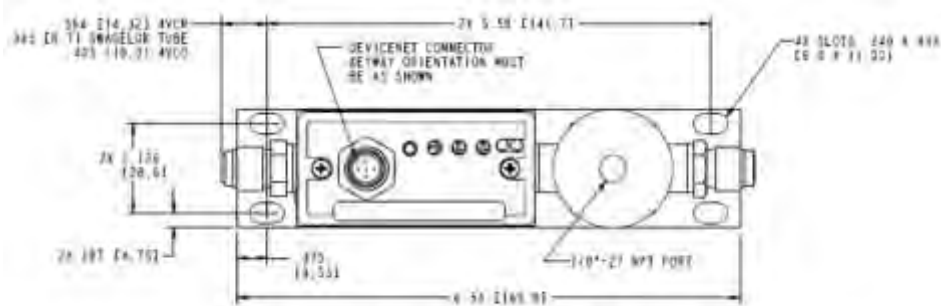

GV50A - Mounting Plate Slot Location

Figure 3: Mounting Screw Holes Locations for In-Line Axial Gas Flow Compression Fittings

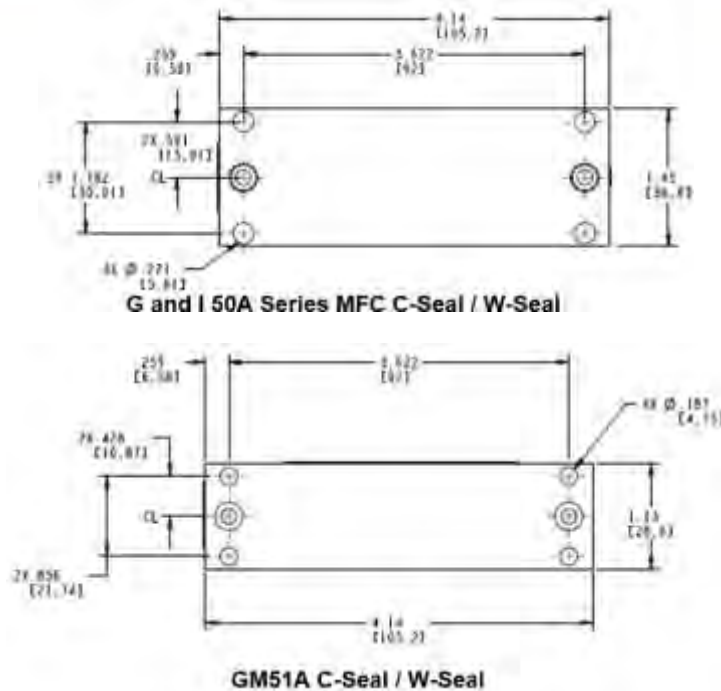

Figure 4: Mounting Bolt Holes Location for Non-Axial Gas Flow Compression Fittings

4.5 Checking the Leak Tight Seal for the MFC

With the MFC body mounted in its gas panel location, connect the external gas line fittings using the appropriate gasket type and material for the MFC process application.

Install and tighten the gasket material according to the fitting manufacturer’s instructions and specifications.

4.6 Applying Power and Signal Cables to the MFC

Connect the appropriately designed power and signal cables to the MFC interface. Secure the cable to posts on each side of the MFC connector.

CAUTION

Before connecting any cable to the MFC, verify that the power supply being used for this application meets the MKS’s recommendation for voltage and current ratings. **DO NOT** submit the MFC to an over voltage condition in order to avoid damaging the MFC during power up.

NOTE

One important aspect of determining the appropriate cable design for 15 and 9 pin analog I/O is to review and understand how the MFC signal commons and power common are going to be tied together for the system installation. It is extremely important that these electrical commons are tied at one location between the power source and the MFC in order to avoid potential ground loops which can result in analog flow signal offsets and even increased noise in the flow signal.

NOTE

Before connecting any cable to the MFC, verify that all pinouts for power and signals match those for the I/O type being used. Pertinent information is provided in Analog Power and Control I/O Definitions, below, and Digital I/O Connections, page 25).

NOTE

Cables and other accessories manufactured by MKS for the G and I Series MFCs are listed in Appendix C.

If you choose to manufacture your own cables, use the following guidelines for cable construction:

1. The cable must have an overall metal braided shield, covering all wires. Neither aluminum foil nor spiral shielding will be as effective; using either may nullify regulatory compliance.
2. The connectors must have a metal case with direct contact to the cable shield on the whole circumference of the cable. The inductance of a flying lead or wire from the shield to the connector will seriously degrade the shields effectiveness. Ground the shield to the connector before its internal wires exit.
3. With very few exceptions, the connector(s) must make good contact to the device's case (ground). Good contact is about 0.01 ohms and the ground should surround all wires. Contact to ground at just one point may not suffice.
4. For shielded cables with flying leads at one or both ends; it is important to ground the shield at each such end before the wires exit. Make this ground with absolute minimum length. (A $\frac{1}{4}$ inch piece of #22 wire may be undesirably long since it has approximately 5 nH of inductance, equivalent to 31 ohms at 1000 MHz). After picking up the braid ground, keep wires and braid flat against the case. With very few exceptions, grounded metal covers are not required over terminal strips. If one is required, it will be stated in the Declaration of Conformity.

NOTE

Special considerations must be given to the design of the connector for the I series MFC in order to ensure a water and dust proof seal is generated at the connector interface for the IP66 rated I series MFC. See Appendix C for additional details.

4.6.1 Analog Power and Control I/O Definitions

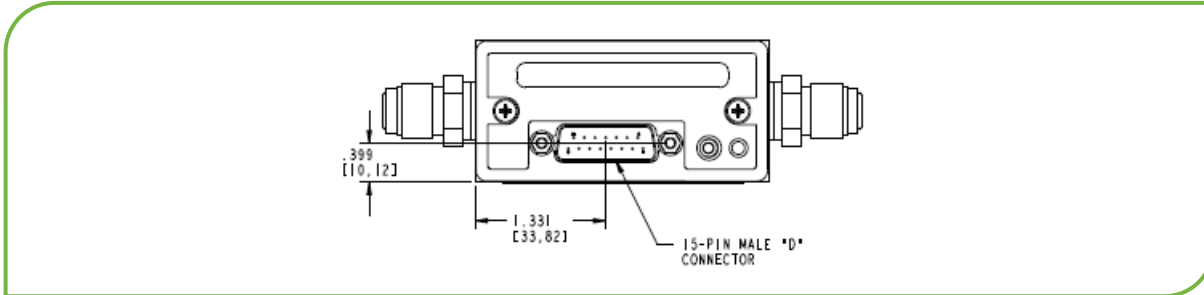

15-PIN ANALOG (I/O TYPE 'B')	
PIN	SIGNAL
1	VALVE TEST POINT
2	FLOW SIGNAL OUTPUT
3	VALVE CLOSE
4	VALVE OPEN
5	POWER COMMON
6	NO CONNECTION
7	+15 TO +24 VDC
8	SETPOINT INPUT
9	NO CONNECTION
10	OPTIONAL INPUT
11	SIGNAL COMMON
12	SIGNAL COMMON
13	NO CONNECTION
14	NO CONNECTION
15	CHASSIS GROUND

15-PIN ANALOG (I/O TYPE 'M')	
PIN	SIGNAL
1	VALVE TEST POINT
2	FLOW SIGNAL OUTPUT
3	VALVE CLOSE
4	VALVE OPEN
5	POWER COMMON
6	NO CONNECTION
7	+15 TO +24 VDC
8	SETPOINT INPUT
9	NO CONNECTION
10	OPTIONAL INPUT
11	SIGNAL COMMON
12	SIGNAL COMMON
13	NO CONNECTION
14	NO CONNECTION
15	CHASSIS GROUND

15-PIN BROOKS PINOUT (I/O TYPE 'E')	
PIN	SIGNAL
1	SIGNAL COMMON
2	FLOW SIGNAL OUT
3	NO CONNECTION
4	NO CONNECTION
5	+15 TO +24 VDC
6	NO CONNECTION
7	VALVE TEST POINT
8	SETPOINT INPUT
9	POWER COMMON
10	SIGNAL COMMON
11	NO CONNECTION
12	VALVE OVERRIDE
13	NO CONNECTION
14	CHASSIS GROUND
15	OPTIONAL INPUT

15-PIN CELERITY UDU45 PINOUT (I/O TYPE 'U')	
PIN	SIGNAL
1	SIGNAL COMMON
2	NO CONNECTION
3	NO CONNECTION
4	+15 TO +24 VDC
5	NO CONNECTION
6	FLOW SIGNAL OUT
7	POWER COMMON
8	CHASSIS GROUND
9	VALVE CLOSE
10	NO CONNECTION
11	NO CONNECTION
12	VALVE TEST POINT
13	SIGNAL COMMON
14	SIGNAL COMMON
15	SETPOINT INPUT

Figure 5: Analog I.O – 15 pin

NOTE

I/O Type M has pins 11 and 12 signal commons tied to pin 5 power common internally in the MFC.

Brooks and Celerity compatible 15 pin I/O's available for GE50/GM50/GV50/GM100 models.

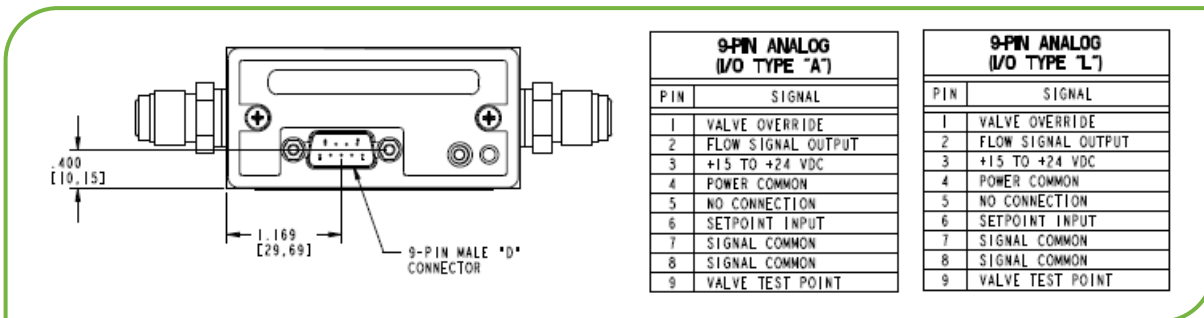

9-PIN ANALOG (I/O TYPE 'A')	
PIN	SIGNAL
1	VALVE OVERRIDE
2	FLOW SIGNAL OUTPUT
3	+15 TO +24 VDC
4	POWER COMMON
5	NO CONNECTION
6	SETPOINT INPUT
7	SIGNAL COMMON
8	SIGNAL COMMON
9	VALVE TEST POINT

9-PIN ANALOG (I/O TYPE 'L')	
PIN	SIGNAL
1	VALVE OVERRIDE
2	FLOW SIGNAL OUTPUT
3	+15 TO +24 VDC
4	POWER COMMON
5	NO CONNECTION
6	SETPOINT INPUT
7	SIGNAL COMMON
8	SIGNAL COMMON
9	VALVE TEST POINT

Figure 6: Analog I.O – 9 pin

NOTE

I/O Type L has pins 11 and 12 signal commons tied to pin 5 power common internally in the MFC.

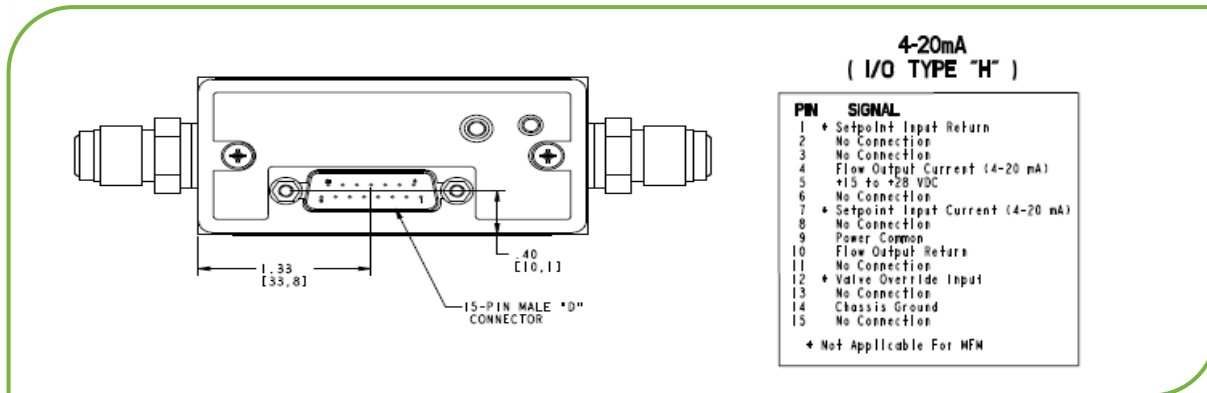

Figure 7: Analog I.O – 4-20 mA

NOTE

For set point input, the current source should have enough compliance voltage to be able to account for drops in transmission lines and drive the set point circuit with a shunt resistance of 175 ohms (protection circuit – 25 ohms, set point circuit - 150 ohms) to generate the appropriate a 4 – 20mA current signal.

Important G and I Series Design Features for the Analog MFC

Status LED — Located on the top of the MFC cover, the status light confirms that power has been applied correctly and the MFC has successfully completed an initialization routine by turning solid green several seconds after power is connected to the device. After powering up, if the indicator light remains solid red after power up, contact MKS service.

Zero Button — Just to the left of the LED status indicator is a zero button. To execute a MFC zero from this location, depress and hold the button down for 3 seconds. Refer to *Zeroing the MFC*, page 60, for the basic procedures to follow to execute a proper zero for the flow sensor.

NOTE

Due to the dust and moisture requirements for the IP 66 rating, these features are not visible or accessible on the I Series MFC.

Valve Override — All analog connectors have pin locations that allow the execution of a valve override close or valve override open. The wiring requirements for the connector pin(s) to drive a valve closed or open are dependent on whether the MFC I/O is a 9 or 15 pin D-dub design.

- 9 pin — The voltage between pin 1 (valve override) and pin 4 (power common) floats at 2.5V when the device is powered up. To execute a valve close, pull pin 1 to ground. To execute a valve open, pull pin 1 to 5V.
- 15 pin — To execute a valve close, pull pin 3 to ground. To execute a valve open, pull pin 4 to ground.

Optional Input (15 pin only) — This feature has been used extensively as a means to take an external pressure signal, feed it back into the instrument on pin 10 to modulate the valve, and effectively turn the MFC into a pressure controller. Additional details on how to set up the MFC for optional input pressure control are available in Appendix A.

4.6.2 Digital I/O Connections

RS485 Communication Description

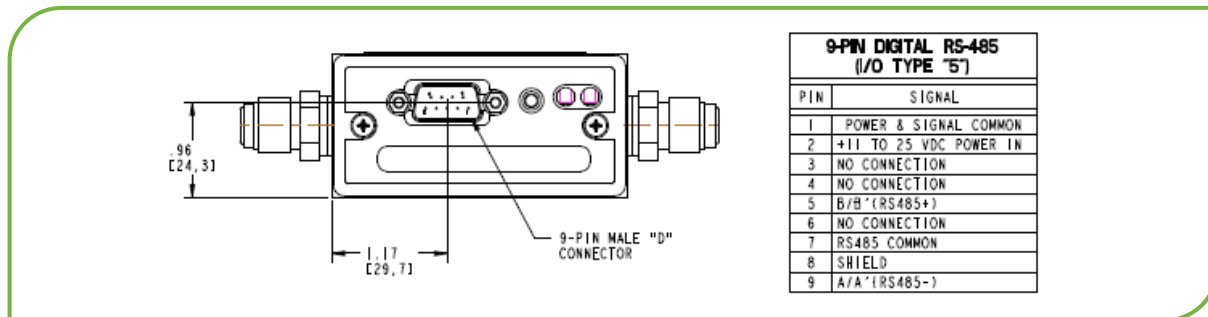

Figure 8: RS485 Communication Protocol

- G and I Series MFC serial communication uses drivers to send digital messages based on a variable length ASCII format that sends a message to a specific address and then waits for the MFC's response before trying to communicate with the next device.
- This format has been used in MKS legacy MFC RS485 devices such as the 1179 and 1479, and makes the integration of the G and I series into existing 1179/ 1479 applications easier for the end user.
- RS485 communication supports multi-device bus drop designs.
- MKS Document MKS G-Series MFC, RS485 Supplement (1046411-001) provides additional information on RS485 command structure and MFC features supported by the Type 5 RS485 specification.

G Series RS485 MFC Features

LED Status Indicators — There are two LED lights for error and communication. When you apply power to the digital MFD, a series of steps occur as the unit is initializes. As each step occurs, the COMM LED on the top of the unit illuminates. During MFC initialization, the two device LEDs will blink 3 times after which the COMM LED will stay solid amber. The COMM LED sequence, which takes about 10 seconds, must be completed before any communication commands are issued. Refer to *DeviceNet*, page 86, for additional information about LED status definitions.

Zero Button — Just to the right of the connector is a zero button. To execute an MFC zero from this location, depress and hold the button down for 3 seconds. Refer to *Zeroing the MFC*, page 60, for the basic procedures to follow to execute a proper zero for the flow sensor.

Selectable Serial Baud Rate — G series RS485 supports baud rates of 9600, 19200, and 38400. The factory default is 9600 and can be changed using setup commands over RS485 (see *G-Series MFC, RS485 Supplement* (1046411-001) for additional command details). Baud rates also can be selected using the “Setup Mode” of the MFC embedded web browser.

Selectable RS485 Address — Each MFC connected serially in a RS485 network must have a unique address. The G Series default address is 254 and can be changed using setup commands over RS485 (see *G-Series MFC, RS485 Supplement* (1046411-001) for command details). The RS485 address may be changed using the “Setup Mode” of the MFC embedded web browser. Refer to the Appendix B tutorial for the establishing Ethernet communications to the G Series MFC web browser and to enter the “Setup Mode” for access to MFC variables.

G and I Series DeviceNet Communication Description

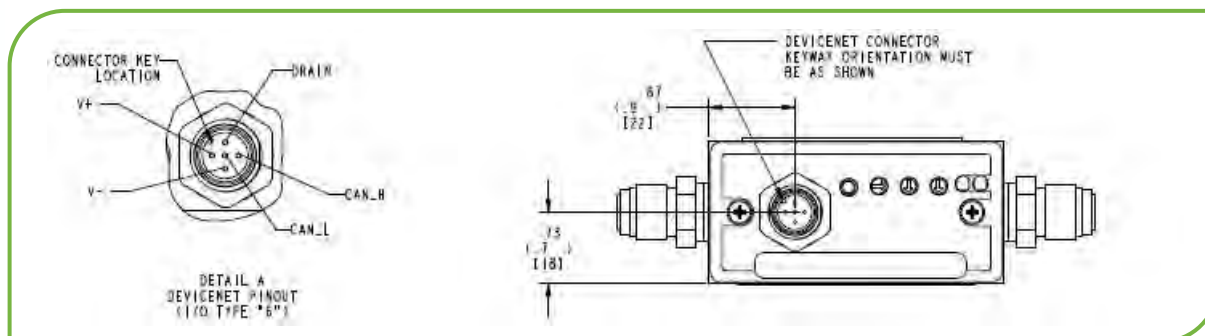

Figure 9: DeviceNet Communication Protocol

- DeviceNet communication is a master/slave (MFC) relationship comprised of a physical layer that makes up the trunk-line topology connecting devices and the data-link layer that is automatically capable of arbitrating message traffic between the master and the MFC slave.
- The G and I Series MFC DeviceNet Mass Flow Device complies with the ODVA DeviceNet Specification Volume I and Volume II [1, 2], and the SEMI Standards Common and Specific Device

Models [3, 4]. Refer to those documents for a complete functional description of the MFC Mass Flow Device along with the *MKS G-Series MFC DeviceNet Supplement* (1046412-001).

G and I DeviceNet MFC Features

LED Status Indicators — Two bi-color LED status indicators are located on the top of the MFC enclosure for network (NET) and module (MOD) status. During MFC initialization, the NET and MOD will toggle green and red for 2 seconds, and the MOD light will remain solid green. Once a DeviceNet network has been detected by the MFC, the NET LED will begin blinking green. Once connected to the DeviceNet network, the NET LED will be solid green. Refer to *DeviceNet*, page 86, for additional information about LED status definitions.

Zero Button — Just to the right of the connector is a zero button. To execute a MFC zero from this location, depress and hold the button down for 3 seconds. The MFC can also be zeroed using commands over primary I/O messaging or via the Ethernet web browser. Refer to *Zeroing the MFC*, page 60, for the basic procedures to follow to execute a proper zero for the flow sensor.

Baud Rate Selection — Default factory baud rate is 500 kps. Baud rate selection can be physically selected by using the 4-position rotary switch on the top of the MFC enclosure to select one of the three allowable choices (125, 250, 500 kps) or by placing the switch to PGM and using DeviceNet programming commands (the value is read from the non-volatile memory).

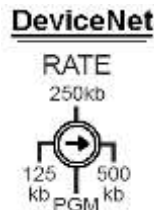

Figure 10: DeviceNet 4-Position Rotary Switch

DeviceNet MAC ID (Node Address) Switches — A pair of rotary switches located on the top of the MFC enclosure are used to set a unique node address for every device on the network. The factory default is 55. Valid switch positions for a DeviceNet network are from 00 to 63. The MSD (most significant digit) (MSD switch represents an increment of 10 (0, 10, 20, etc...60), while the LSD (least significant digit) switch represents an increment of 1 (0-9).

It is also possible to use the PGM position on the MSD switch and set the node address using DeviceNet commands. The master will read the node address from non-volatile memory.

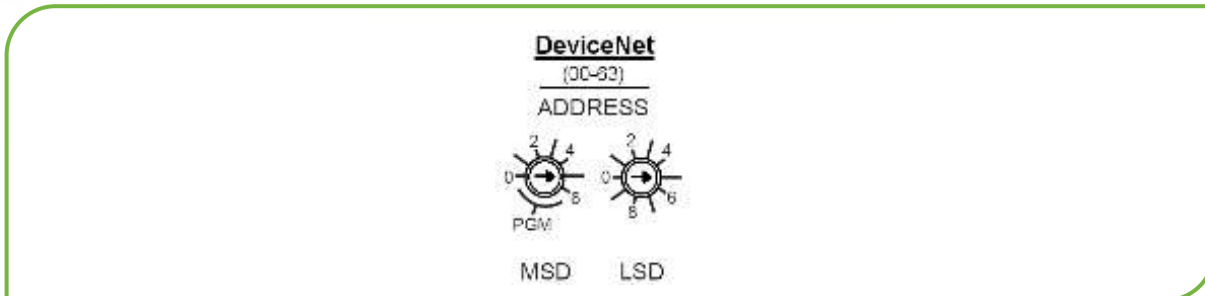

Figure 11: DeviceNet Pair of Rotary Switches

NOTE

Due to the dust and moisture requirements for the IP 66 rating, these features are not visible or accessible on the I Series MFC. All set up of these parameters must be accomplished using DeviceNet commands or over Ethernet communications using the web browser.

G and I Series Profibus Communication

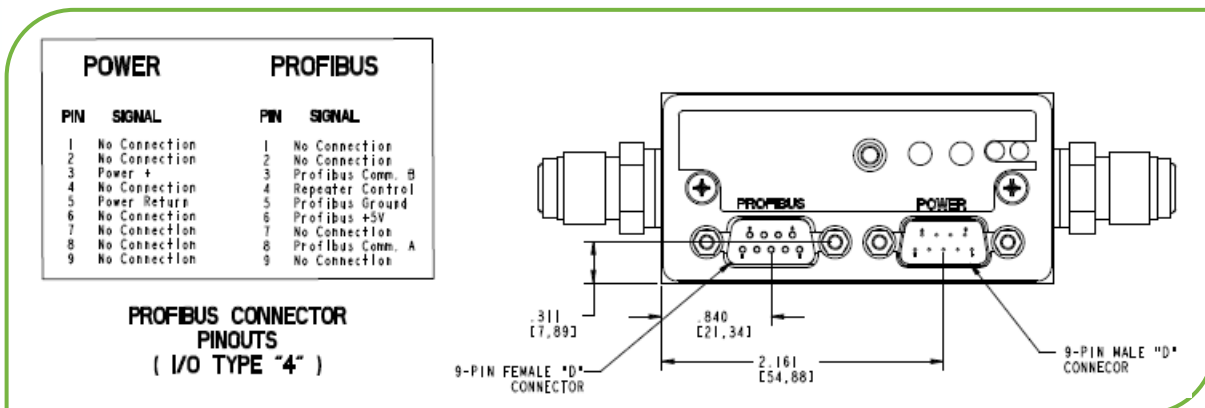

Figure 12: Profibus I/O Communications Protocol

- Master/slave (MFC) field bus communication protocol uses a serial approach to control bit transmission between the master and slave. With one master to control the network, the master sends an output message to a slave device that must provide input information immediately back to the master before the master will query another network device.
- Refer to the complete functional description of the MFC Mass Flow device along with the *MKS G-Series MFC, Profibus Supplement (1046413-001)*.

NOTE

Profibus model code has firmware revisions 3 and 4 available for G series MFC. See **Model Code Configuration** for additional details to determine the proper revision for the application.

G and I Series Profibus MFC Features

The two 9-pin D-sub connector design has a male connector for Profibus communication and female connector for MFC power.

LED Status Indicators — The MFC is designed with two standard bi-color (amber/red) Profibus status LEDs for network (NET) and module (MOD) status located on the top of the MFC enclosure. When power is supplied to the 9 pin male power connector on the MFC, the LED will toggle green and red during initialization for a few seconds before the MOD LED turns solid green. When the 9-pin female Profibus communication connector is connected and recognized by the master, the NET LED will begin to blink green. Refer to *DeviceNet*, page 86, for additional information about LED status definitions.

Zero Button — Just to the right of the connector is a zero button. To execute a MFC zero from this location, depress and hold the button down for 3 seconds. The MFC can also be zeroed using commands over primary I/O messaging or via the Ethernet web browser. Refer to *Zeroing the MFC*, page 60, for the basic procedures to follow to execute a proper zero for the flow sensor.

G Series Ethercat Communication

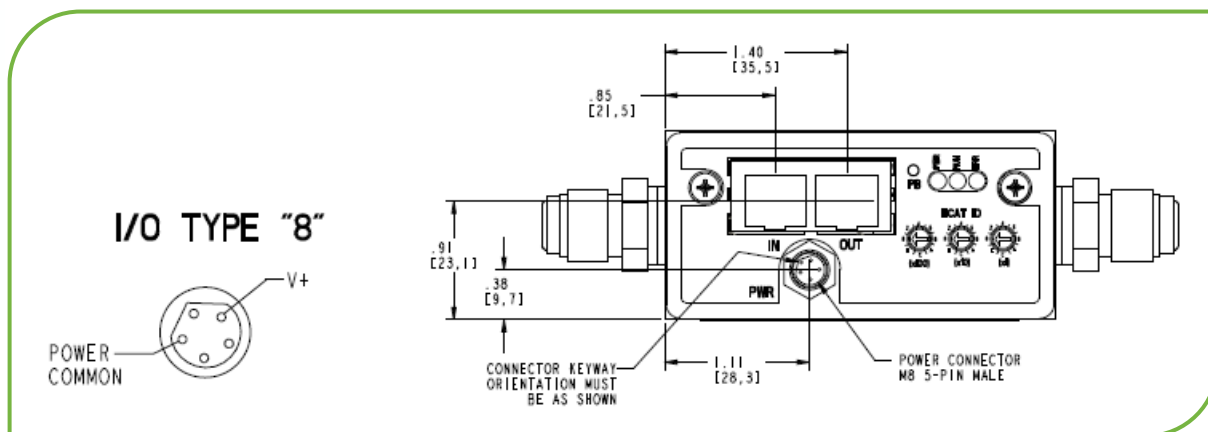

Figure 13: EtherCat I/O Communications Protocol

- Ethercat is a high performance Ethernet based fieldbus network protocol that takes advantage of the efficient way messages between the master and slave devices propagate through the network. Messages or instructions from the master are “passed through” each slave device (node), and corresponding data from the slave device is added to the output message that is going to the next node in the network. This process continues throughout the network and, when the message arrives

back at the master, every slave has received new input data from the master and returned new output data to the master.

- Ethercat requires an ESI file that provides the master with an appropriate configuration file specific to a G Series MFC.
- A detailed device specific profile for the G Series MFC has been created for Ethercat communication in document ETG.5003.2020 S (R) V1.0.0.

G Series Ethercat MFC Features

Two Ethernet ports marked <IN> and <OUT> are used to propagate messages from the master (IN), adding any data to the string and then allowing message to pass to the next slave or node (OUT).

Push button (PB) can be used to zero the MFC flow. To execute a MFC zero from this location, depress and hold the button down for 3 seconds.

There are three LEDs for Power (PWR), Network communication (RUN), and network issues (ERR).

LED status indicators function as follows:

- When power has been established, the PWR LED will turn solid green.
- The RUN LED will remain dark until a network connection between the master and slave has been established and the device has been put in an operational mode by the master. At this time, the slave device will respond to messages from the master and the LED is solid green.
- The ERR LED stays dark as long as there are no issues between the master and the slave. If an issue is detected, the LED will flash red.

ECAT ID consists of three rotary switches that provide an option of manually setting the node address (function is normally automatic from the master). A maximum of 4095 distinct addresses can be set by these rotary switches and it is important to note that these switches are in HEX (max setting FFF = 4095 decimal).

G Series Profinet Communications

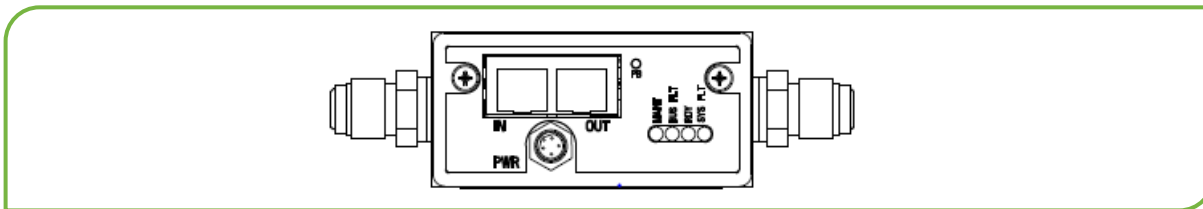

Figure 14: Profinet I/O Communications Protocol

- Profinet is a master (I/O controller) / slave (I/O device) communication protocol designed to provide a high level of automation over an industrial Ethernet network with data exchange rates on the order of a few milliseconds. Cyclic data exchange is point to point between the I/O controller and I/O device.
- Profinet requires that the MFC device characteristics be defined in a GSDML file and provides the I/O supervisor software with configuration information about the G Series MFC.

G Series MFC Features

Two Ethernet ports marked <IN> and <OUT> are used to propagate cyclic messages back and forth from the I/O controller and the I/O device.

Push button (PB), which is located next to the <OUT> Ethernet port, can be used to zero the MFC flow. To execute a MFC zero from this location, depress and hold the button down for 3 seconds.

There are four LEDs to verify successful communication between the I/O controller and I/O device:

- MAINT (Maintenance) — Not used by MKS (dark).
- BUS FLT (Bus Fault) — Red on power up and dark when a TPS-1 (I/O controller) link is established.
- RDY (Ready) — Solid Green on power up and when a TPS-1 link is established.
- SYS FLT (System Fault) — Dark on power up and red if an issue is detected.

4.7 Leak Checking the MFC Installation

Perform leak checks on gas lines and MFC connections to verify the integrity of the gas seals before introducing any process gas to the MFC using appropriate Helium leak detection equipment or other methodology specified by the gas panel designer.

4.8 Setting Up and Configuring the MFC

Connect the G/I Series MFC to a desktop computer or laptop using a standard Ethernet cable in order to utilize the embedded web browser interface to verify that the as-received configuration from the manufacturer matches the MFC gas and full scale flow rate designated on the MFC label attached to its enclosure.

Details on how to set up the computer in order to establish communication to the MFC and the functionality of the web browser are described in Appendix B.

Changes to the configuration of the MFC can also be initiated and completed over the web browser interface including:

- Re-ranging the full scale of the current nameplate gas
- Creating a new gas type

- Changing the factory IP address of the device if you have multiple devices on a multiport hub or switch
- Setting ramps rates and set point delay times for process requirements

4.9 Zeroing the MFC

Proper zeroing of the MFC is one of the most critical steps to ensure that the MFC performs correctly in any application.

The two most important considerations when zeroing an MFC are making sure:

- The MFC has reached a stable internal temperature in the orientation (attitude) that is being used for the application, and
- No differential pressure exists across the MFC control valve (“no flow”) when a zero is initiated.

To ensure that these conditions are met, refer to the following recommended guidelines and procedures.

4.9.1 Check Temperature Stabilization

The MFC should be powered up in its final installation orientation for at least 30 minutes before initiating an MFC zero. MKS recommends additional steps to verify that MFC has reached a stable temperature by using the plot page available on the web browser to monitor the MFC temperature in real time prior to zeroing the MFC.

4.9.2 Establish a Proper “No Flow” Condition Across the MFC Control Valve

The definition of a “no flow” condition is that the pressure on the inlet side of the MFC is equal to the pressure on the outlet side of the MFC control valve. Whether the MFC is at atmospheric pressure, vacuum pressure, or process pressure, the zero should not be initiated until the pressure differential across the MFC is zero.

NOTE

MKS recommends that an MFC be zeroed at its operating inlet gas pressure. To successfully complete the recommended procedures, a positive shut off valve should be installed in the gas line to properly isolate the MFC at operating pressures.

1. Pressurize the gas line to the inlet of the MFC (open upstream positive shut off valve if required).
2. Open the downstream shut off valve and give the MFC a full scale set point.
3. Let the MFC operate at full scale flow for 15 seconds and then close the downstream shut off valve while leaving the set point on the MFC.

4. Allow the reported flow to fall to a stable zero value.

NOTE

The set point and flow signals can be monitored in real time on the plot page to confirm that the MFC has reached a stable zero condition.

5. If a positive shut off valve is installed upstream, close the valve and then give a zero set point to the MFC to close the control valve.
6. Issue a zero function to the MFC by holding down the button on the top of the enclosure for 3 seconds.

NOTE

The zero function can be also executed from the Configuration page of the web browser (see Appendix B).

Digital protocols such as DeviceNet, Profibus, RS485, Ethercat, and Modbus also support zero commands that can be sent over the primary I/O (see I/O supplemental documentation for details).

5 MFC Product Code Definition and Design Configurations

5.1 G and I Series Elastomer Models

5.1.1 Elastomer Sealed G and I Series Product Code Structure

CCCCC	GGG	FFF	Y	W	Z	V	AA
Configuration Code							
Gas Code							
Flow Range Full Scale							
Fittings							
Connector Type							
Seal Material							
Valve Type							
Firmware Version							

5.1.2 MFC Configuration Code – CCCCC

Table 9: MFC Configuration Code – CCCCC

MFC Configuration Code – CCCCC
CCCCC
GE50A
IE50A
GV50A

5.1.3 Gas Code – GGG

MKS gas code designations are in accordance to *SEMI Guideline E52, Practice for Referencing Gases and Gas Mixtures Used in Digital Mass Flow Controllers*.

NOTE

Information for SEMI gas codes is provided in Appendix A.

5.1.4 Flow Full Scale Range Designation – FFF

The full scale flow for the MFC is defined by a 3-digit code as shown in the table below.

Table 10: Flow Full Scale Range Designation – FFF

Mass Flow Rate	Full Scale Flow		MFC Model		
	Ordering Code Designation		GE50A	IE50A	GV50A
10 sccm	101		●	●	●
20 sccm	201		●	●	●
50 sccm	501		●	●	●
100 sccm	102		●	●	●
200 sccm	202		●	●	●
500 sccm	502		●	●	●
1000 sccm	103		●	●	●
2000 sccm	203		●	●	●
5000 sccm	503		●	●	●
10000 sccm	104		●	●	●
20000 sccm	204		●	●	●
30000 sccm	304		●	●	●
50000 sccm	504		●	●	●

5.1.5 MFC Fittings – Y

Table 11: MFC Fittings – Y

MFC Model and Fitting Combinations					
Fittings Type Description	Product Code	Fitting Utilizationi	GE50A	IE50A	GV50A
Swagelok 2 VCR Male	B	< 1000 sccm N2 Equivalent	●	●	●
Swagelok 4 VCR Male	R	All MFC Full Scale Flow Ranges	●	●	●
Swagelok 8 VCR Male	T	All MFC Full Scale Flow Ranges	●	●	●
1/8" Swagelok	A	< 1000 sccm N2 Equivalent	●	●	●
1/4" Swagelok	S	All MFC Full Scale Flow Ranges	●	●	●
3/8" Swagelok	J	All MFC Full Scale Flow Ranges	●	●	●
1/2" Swagelok	K	All MFC Full Scale Flow Ranges	●	●	●
6 mm	M	All MFC Full Scale Flow Ranges	●	●	●
8 mm	E	All MFC Full Scale Flow Ranges	●	●	●
10 mm	P	All MFC Full Scale Flow Ranges	●	●	●
12mm	F	All MFC Full Scale Flow Ranges	●	●	●
C Seal Surface Mount	C	All MFC Full Scale Flow Ranges	●	●	●
4 VCO Male	G	All MFC Full Scale Flow Ranges	●	●	●
8 VCO Male	D	All MFC Full Scale Flow Ranges	●	●	●
KF16	U	All MFC Full Scale Flow Ranges	●	●	●

5.1.6 MFC Power and Control I/O Connector – W

Analog Control I/O

Table 12: Analog Control I/O

Analog I/O	Product Code	GE50A	IE50A	GV50A
15 pin D sub	B ¹ , M (Grounds Tied ²)	●		●
15 pin D sub	B		●	
9 pin D sub	A ¹ , L (Grounds Tied ²)	●		●
9 pin D sub	A		●	
15 pin 4-20mA	H	●	●	●
15 Pin D sub	K ³	●		●
15 pin D sub	E	●		●
15 pin D sub	U	●		●

¹ 15-24V, signal and power common are not tied internally in MFC.

² 15-24V, signal and power common tied together internally, compatible with MKS legacy MFC designs.

³ Special 24V connector designed to be compatible with 1179B.

⁴ Compatible with Brooks 15 pin Analog

⁵ Compatible with Celerity 15 pin Analog

Digital I/O Protocols

Table 13: Digital I/O Protocols

Digital I/O	Product Code	GE50A	IE50A	GV50A
RS 485	5	●		●
DeviceNet	6	●		●
Profibus	3 ¹ , 4 ²	●	●	●
Ethercat	8	●		●
Profinet	9	●		●

¹ Model Code 3 – Profibus Full setup, compatible with 1179B.

² Model Code 4 – Profibus Small setup, compatible with 1480 and 1179.

5.1.7 Elastomer Seal Materials – Z

Table 14: Elastomer Seal Materials – Z

Seal Materials	Product Code	GE50A	IE50A	GV50A
Viton	V	●	●	●
Buna -N	B	●	●	●
Neoprene	N	●	●	●
Kalrez	K	●	●	●
EPDM	E	●	●	●

5.1.8 Valve Type – V

Table 15: Valve Type – V

MKS Valve Designations	Product Code	GE50A	IE50A	GV50A
Valve Type – Normally Closed	O	●	●	●
Valve Type – Normally Open	P	●	●	

5.1.9 Firmware Revision – AA

The latest version of firmware for the MFC model is installed in the device unless something different is specified by the customer or the model code is a 5-digit sequential that has specific instructions for device configuration.

5.2 G and I Series Metal Sealed Model

5.2.1 Metal Sealed G and I Series Product Code Structure

CCCCC	GGG	FFF	Y	W	V	AA
Configuration Code						
Gas Code						
Flow Range Full Scale						
Fittings						
Connector Type						
Device Type / Valve and Seal Material						
Firmware Version						

5.2.2 MFC Configuration Code – CCCCC

Table 16: MFC Configuration Code – CCCCC

MFC Configuration Code – CCCCC
CCCCC
GM50A
IM50A
GM51A
GM100A

5.2.3 Gas Code – GGG

MKS gas code designations follow *SEMI Guideline E52, Practice for Referencing Gases and Gas Mixtures Used in Digital Mass Flow Controllers*.

NOTE

Information for SEMI gas codes is provided in Appendix A.

5.2.4 Full Scale Range – FFF

Table 17: Full Scale Range– FFF

Mass Flow Rate	Full Scale Flow Ordering Code Designation	MFC Model			
		GM50A	IM50A	GM51A	GM100A
10 sccm	101	●	●	●	
20 sccm	201	●	●	●	
50 sccm	501	●	●	●	
100 sccm	102	●	●	●	
200 sccm	202	●	●	●	
500 sccm	502	●	●	●	
1000 sccm	103	●	●	●	
2000 sccm	203	●	●	●	
5000 sccm	503	●	●	●	
10000 sccm	104	●	●	●	
20000 sccm	204	●	●	●	
30000 sccm	304	●	●	●	
50000 sccm	504	●	●	●	
100000 sccm	105				●

5.2.5 Fittings – Y

Table 18: Fittings – Y

MFC Model and Fitting Combinations						
Fittings Type Description	Product Code	Fitting Utilization ¹	GM50A	IM50A	GM51A	GM100A
Swagelok 2 VCR Male	B	< 1000 sccm N2 Equivalent	●	●		
Swagelok 4 VCR Male	R	All MFC Full Scale Flow Ranges	●	●	●	●
Swagelok 8 VCR Male	T	All MFC Full Scale Flow Ranges	●	●		●
1/8" Swagelok	A	< 1000 sccm N2 Equivalent	●	●		
1/4" Swagelok	S	All MFC Full Scale Flow Ranges	●	●		
3/8" Swagelok	J	All MFC Full Scale Flow Ranges	●	●		●
1/2" Swagelok	K	All MFC Full Scale Flow Ranges	●	●		●
6 mm	M	All MFC Full Scale Flow Ranges	●	●		
8 mm	E	All MFC Full Scale Flow Ranges	●	●		
10 mm	P	All MFC Full Scale Flow Ranges	●	●		●
12 mm	F	All MFC Full Scale Flow Ranges	●	●		●

MFC Model and Fitting Combinations						
Fittings Type Description	Product Code	Fitting Utilizationi	GM50A	IM50A	GM51A	GM100A
C Seal Surface Mount	C	All MFC Full Scale Flow Ranges	●	●	●	
W Seal Surface Mount	H	All MFC Full Scale Flow Ranges	●		●	
4 VCO Male	G	All MFC Full Scale Flow Ranges				
8 VCO Male	D	All MFC Full Scale Flow Ranges				●
KF16	U	All MFC Full Scale Flow Ranges	●	●		

5.2.6 Power and Control I/O Connector – W

Analog Control I/O

Table 19: Analog Control I/O

Analog I/O	Product Code	GM50A	IM50A	GM51A	GM100A
15 pin D sub	B ¹ , M (Grounds Tied ²)	●	●		●
15 pin D sub	B		●		
9 pin D sub	A ¹ , L (Grounds Tied ²)	●			●
9 pin D sub	A			●	
15 pin 4-20mA	H	●	●	●	●
15 Pin D sub	K ³	●			●
15 pin D sub	E	●			●
15 pin D sub	U	●			●

¹ 15-24V, signal and power common are not tied internally in MFC.

² 15-24V, signal and power common tied together internally, compatible with MKS legacy MFC designs.

³ Special 24V connector designed to be compatible with 1179B.

⁴ Compatible with Brooks 15 pin Analog

⁵ Compatible with Celerity 15 pin Analog

Digital I/O

Table 20: Digital I/O

Digital I/O	Product Code	GM50A	IM50A	GM51A	GM100A
RS 485	5	●		●	●
DeviceNet	6	●		●	●
Profibus	3 ¹ , 4 ²	●	●		●
Ethercat	8	●		●	●
Profinet	9	●		●	●

¹ Model Code 3 – Profibus Full setup, compatible with 1179B.

² Model Code 4 – Profibus Small setup, compatible with 1480 and 1179.

5.2.7 Valve Type – V

Table 21: Valve Type – V

MKS Type / Valve Designations	Product Code	GM50A	IM50A	GM51A	GM100A
Mass Flow Controller / Normally Closed / Teflon Seal	M0	●	●	●	
Mass Flow Controller / Normally Closed / Viton Seal	MV				●
Mass Flow Controller / Normally Closed / Buna Seal	MB				●
Mass Flow Controller / Normally Closed / Neoprene Seal	MN				●
Mass Flow Controller / Normally Closed / EPDM Seal	ME				●
Mass Flow Controller / Normally Open / Teflon Seal	PT	●	●		
Mass Flow Meter	30	●	●	●	●

5.2.8 Firmware Revision – AA

The latest version of firmware for the MFC model is installed in the device unless something different is specified by the customer or the model code is a 5-digit sequential that has specific instructions for device configuration.

6 Troubleshooting and Maintenance

6.1 MFC Setup and Function Troubleshooting

Table 22: MFC Setup and Function Troubleshooting

	Analog I/O		Digital I/O	
MFC Status / Module Light Dark	No power	Check power source.	No power	Check power source.
	Low power	Check supply voltage.	Low power	Check supply voltage.
	Cable Design	Verify I/O pinout.	Cable Design	Verify I/O pinout.
	Bad cable connection	Check pin(s) continuity.	Bad cable connection	Check pin(s) continuity. DNET - Verify that there is no path from the DNET electrical connector pins and chassis ground.
MFC does not respond to any setpoint	Verify Analog Status Led is solid green	If LED is DARK check power source. If LED is RED , contact MKS Service.	Verify Module LED or Power LED (Ethercat) is solid green	If LED is DARK check power source. If LED is RED , contact MKS Service.
	Control circuit failure	Follow Appendix B and use the Ethernet Web Browser to observe and diagnose set point and flow response. If unresponsive contact MKS Service.	Verify the MFC is communicating with the I/O Network	DNET I/O - NET LED Blinking no connection. Profibus I/O - Solid NET LED no connection. RS485 - Solid NET LED no connection. Ethercat - Dark NET LED no connection.

		Analog I/O	Digital I/O
<p><i>MFC does not respond to any setpoint (continued)</i></p>	Contamination/Clogged - blocked MFC device or gas line	Check inlet pressure @ MFC. Check outlet pressure at MFC using pressure gauge. Check outlet pressure downstream of positive shut off (pneumatic) valve downstream of MFC. Check air line to pneumatic valve. Check for any restriction such as filter or check valve downstream of MFC.	Control circuit failure Follow Appendix B and use the Ethernet Web Browser to observe and diagnose set point and flow response. If unresponsive contact MKS Service.
	Wrong cable	Verify cable and MFC pinouts are correct for MFC.	Wrong cable Check cable pin out design and verify digital communication lines are correct for Profibus and RS485.
	Bad cable connection	Check pin(s) continuity.	Contamination/Clogged - blocked MFC device or gas line Check inlet pressure @ MFC. Check outlet pressure at MFC using pressure gauge. Check outlet pressure downstream of positive shut off (pneumatic) valve downstream of MFC. Check air line to pneumatic valve. Check for any restriction such as filter or check valve downstream of MFC.

		Analog I/O		Digital I/O	
MFC shows 0 flow when given setpoint	Closed upstream and/or downstream pneumatic valves	Open valves, check inlet pressure.	Closed upstream and/or downstream pneumatic valves	Open valves, check inlet pressure.	
	No gas supply	Turn on gas supply.	No gas supply	Turn on gas supply.	
	Upstream clogged filter/component	Check flow through of components by measuring pressure from gas supply to MFC inlet.	Upstream clogged filter/component	Check flow through of components by measuring pressure from gas supply to MFC inlet.	
	MFC clogged orifice	Verify MFC inlet pressure, check valve current for open valve condition. Check for gas flow downstream of MFC. If flow does not exist, possible clogged orifice.	MFC clogged orifice	Verify MFC inlet pressure, check valve current for open valve condition. Check for gas flow downstream of MFC. If flow does not exist, possible clogged orifice.	
	MFC clogged sensor	Run MFC diagnostics. Verify MFC inlet pressure, check valve current for open valve condition and check for gas flow downstream of MFC. If flow present, possible clogged sensor.	MFC clogged sensor	Run MFC diagnostics. Verify MFC inlet pressure, check valve current for open valve condition and check for gas flow downstream of MFC. If flow present, possible clogged sensor.	
	MFC control circuit failure	Follow Appendix B and use the Ethernet Web Browser to observe valve current after giving set point. If unresponsive contact MKS Service.	MFC control circuit failure	Follow Appendix B and use the Ethernet Web Browser to observe valve current after giving set point. If unresponsive contact MKS Service.	

		Analog I/O		Digital I/O	
MFC Flow output signal does not match setpoint	Inlet pressure too low	Increase inlet pressure.	Inlet pressure too low	Increase inlet pressure.	
	Outlet pressure too high	Decrease outlet pressure.	Outlet pressure too high	Decrease outlet pressure.	
	Flow signal is not properly grounded.	Verify MFC signal commons and power common are tied together. Check electrical connections for ground loops.	Contamination	Check for partial block orifice or sensor using valve override command over primary I/O. Max flow with valve wide open should be > 110% FS.	
	Contamination	Check for partial block orifice or sensor using Analog pins for valve open override condition. Max flow with valve wide open should be > 110% FS.	Control electronics failure, sensor failure	Follow Appendix B and use the Ethernet Web Browser to observe set point, flow output, valve current, and temperature.	
	Control electronics failure, sensor failure	Follow Appendix B and use the Ethernet Web Browser to observe set point, flow output, valve current, and temperature.			
	Electronics failure - Analog to Digital signal calibration	Follow Appendix B and use the Ethernet Web Browser to observe set point, flow output, valve current. If the valve controls at set points between 10 - 100% FS but the flow output is off by a constant amount,			

		Analog I/O		Digital I/O	
			contact MKS Service,		
MFC cannot achieve FS flow	Inlet pressure low	Increase inlet pressure.		Inlet pressure low	Increase inlet pressure
	Outlet pressure high	Decrease outlet pressure.		Outlet pressure high	Decrease outlet pressure
	Valve / flow sensor contamination	Check valve current for maximum position.		Valve / flow sensor contamination	Check valve current for maximum position
	Valve set up - not enough valve stroke	Use Analog pin for valve open override condition. Max flow with valve wide open should be > 110% FS.		Valve set up - not enough valve stroke	Use appropriate digital command over primary I/O for valve open override condition. Max flow with valve wide open should be > 110% FS.
	Gas line blockage/contamination	Measure pressure drop across from gas supply regulator to MFC inlet. If pressure drop greater than expected check filters, check valves, and other in line components for signs of blockage.		Gas line blockage/contamination	Measure pressure drop across from gas supply regulator to MFC inlet. If pressure drop greater than expected check filters, check valves, and other in line components for signs of blockage.
				MFC setpoint in counts < than 100% FS of 24567 counts.	Verify the DNET Master is sending correct HEX value (0x6000) for FS set point over primary I/O.

		Analog I/O	Digital I/O
MFC shows output flow > FS (overrange)	MFC valve full open	Check valve current for maximum condition.	MFC valve full open Check valve current for maximum condition.
	Pressure drop across MFC is greater than specification	Measure upstream pressure & downstream pressure. Compare to specification.	Pressure drop across MFC is greater than specification Measure upstream pressure & downstream pressure. Compare to specification.
	Faulty valve control circuit/ valve setup	Follow Appendix B and use the Ethernet Web Browser to observe set point, flow output, valve current. Send set points 10 -100% and observe valve current values.	Faulty valve control circuit/ valve setup Follow Appendix B and use the Ethernet Web Browser to observe set point, flow output, valve current. Send set points 10 -100% and observe valve current values.
	Possible contamination in valve assembly	Follow Appendix B and use the Ethernet Web Browser to observe set point, flow output, valve current. Send 0 set point to the MFC and observe flow output. Close downstream isolation valve for additional confirmation of through valve closed conductance leak.	Possible contamination in valve assembly Follow Appendix B and use the Ethernet Web Browser to observe set point, flow output, valve current. Send 0 set point to the MFC and observe flow output. Close downstream isolation valve for additional confirmation of through valve closed conductance leak.
			Set Point values over from Primary I/O master incorrect Validate set point values from the Master to the MFC slave are correct for MFC configuration.

	Analog I/O		Digital I/O	
Output signal matches setpoint @ higher flows, but will not go to 0	MFC valve partial contamination	Cycle-purge device, check valve current.	MFC valve partial contamination	Cycle-purge device, check valve current
	MFC control valve issue	Follow Appendix B and use the Ethernet Web Browser to observe set point, flow output, valve current. Send 0 set point to the MFC and observe flow output. Close downstream isolation valve for additional confirmation of through valve closed conductance leak.	MFC control valve issue	Follow Appendix B and use the Ethernet Web Browser to observe set point, flow output, valve current. Send 0 set point to the MFC and observe flow output. Close downstream isolation valve for additional confirmation of through valve closed conductance leak.
	Pressure differential across valve outside specification	Measure inlet and outlet pressure. Confirm differential pressure meets published MFC specification. Adjust pressure as required.	Pressure differential across valve outside specification	Measure inlet and outlet pressure. Confirm differential pressure meets published MFC specification. Adjust pressure as required.
	Device zero offset	re-zero device with known zero flow conditions.	Device zero offset	re-zero device with known zero flow conditions.
MFC output shows large overshoot	Inlet pressure too high	Decrease inlet pressure.	Inlet pressure too high	Decrease inlet pressure

	Analog I/O		Digital I/O	
<i>MFC output shows large overshoot (continued)</i>	MFC inlet pressure to high for default <Operating Pressure> parameter	Follow Appendix B and use the Ethernet Web Browser to observe <Operating Pressure Parameter (default value is 40). Increase value between 40-90 for control gains to be less aggressive.	MFC inlet pressure to high for default <Operating Pressure> parameter	Follow Appendix B and use the Ethernet Web Browser to observe <Operating Pressure Parameter (default value is 40). Increase value between 40-90 for control gains to be less aggressive.
	MFC not programmed for correct gas - actual gas used different	Check MFC active gas using digital interface or Ethernet GUI.	MFC not programmed for correct gas - actual gas used different	Check MFC active gas using digital interface or Ethernet GUI.
	MFC control parameters set incorrectly	Contact MKS service center.	MFC control parameters set incorrectly	Contact MKS service center.
MFC output slow to respond to setpoint	Inlet pressure too low	Increase inlet pressure.	Inlet pressure too low	Increase inlet pressure.
	MFC inlet pressure to low for default <Operating Pressure> parameter	Follow Appendix B and use the Ethernet Web Browser to observe <Operating Pressure Parameter (default value is 40). Decrease value between 20-40 for control gains to be more aggressive.	MFC inlet pressure to low for default <Operating Pressure> parameter	Follow Appendix B and use the Ethernet Web Browser to observe <Operating Pressure Parameter (default value is 40). Decrease value between 20-40 for control gains to be more aggressive.
	MFC not programmed for correct gas - actual gas used different	Check MFC active gas using digital interface or Ethernet GUI.	MFC not programmed for correct gas - actual gas used different	Check MFC active gas using digital interface or Ethernet GUI.
	MFC control parameters set incorrectly	Contact MKS service center.	MFC control parameters set incorrectly	Contact MKS service center.

		Analog I/O		Digital I/O	
MFC output signal oscillates	Inlet pressure oscillates	Check for faulty regulator.	Inlet pressure oscillates	Check for faulty regulator	
	Inlet pressure too high	Lower inlet pressure.	Inlet pressure too high	Lower inlet pressure	
	MFC inlet pressure to high for default <Operating Pressure> parameter	Follow Appendix B and use the Ethernet Web Browser to observe <Operating Pressure Parameter (default value is 40). Increase value between 40-90 for control gains to be less aggressive.	MFC inlet pressure to high for default <Operating Pressure> parameter	Follow Appendix B and use the Ethernet Web Browser to observe <Operating Pressure Parameter (default value is 40). Increase value between 40-90 for control gains to be less aggressive.	
	MFC nameplate gas not same as actual gas	Check that MFC active gas is the same as the nameplate gas using Ethernet Web Browser.	MFC nameplate gas not same as actual gas	Check that MFC active gas is the same as the nameplate gas using Ethernet Web Browser.	
	MFC valve and control parameter setup	Contact MKS Service Center.	MFC valve and control parameter setup	Contact MKS Service Center.	

6.2 MFC Performance Troubleshooting

Table 23: MFC Performance Troubleshooting

	Analog I/O		Digital I/O	
MFC output shows large overshoot	Inlet pressure too high	Decrease inlet pressure	Inlet pressure too high	Decrease inlet pressure
	MFC inlet pressure to high for default <Operating Pressure> parameter	Follow Appendix B and use the Ethernet Web Browser to observe <Operating Pressure Parameter (default value is 40). Increase value between 40-90 for control gains to be less aggressive.	MFC inlet pressure to high for default <Operating Pressure> parameter	Follow Appendix B and use the Ethernet Web Browser to observe <Operating Pressure Parameter (default value is 40). Increase value between 40-90 for control gains to be less aggressive.
	MFC not programmed for correct gas - actual gas used different	Check MFC active gas using digital interface or Ethernet GUI.	MFC not programmed for correct gas - actual gas used different	Check MFC active gas using digital interface or Ethernet GUI.
	MFC control parameters set incorrectly	Contact MKS service center.	MFC control parameters set incorrectly	Contact MKS service center.
MFC output slow to respond to setpoint	Inlet pressure too low	Increase inlet pressure.	Inlet pressure too low	Increase inlet pressure.
	MFC inlet pressure to low for default <Operating Pressure> parameter	Follow Appendix B and use the Ethernet Web Browser to observe <Operating Pressure Parameter (default value is 40). Decrease value between 20-40 for control gains to be more aggressive.	MFC inlet pressure to low for default <Operating Pressure> parameter	Follow Appendix B and use the Ethernet Web Browser to observe <Operating Pressure Parameter (default value is 40). Decrease value between 20-40 for control gains to be more aggressive.

	Analog I/O		Digital I/O	
<i>MFC output slow to respond to setpoint (continued)</i>	MFC not programmed for correct gas - actual gas used different	Check MFC active gas using digital interface or Ethernet GUI.	MFC not programmed for correct gas - actual gas used different	Check MFC active gas using digital interface or Ethernet GUI.
	MFC control parameters set incorrectly	Contact MKS service center.	MFC control parameters set incorrectly	Contact MKS service center.
MFC output signal oscillates	Inlet pressure oscillates	Check for faulty regulator.	Inlet pressure oscillates	Check for faulty regulator.
	Inlet pressure too high	Lower inlet pressure.	Inlet pressure too high	Lower inlet pressure.
	MFC inlet pressure to high for default <Operating Pressure> parameter	Follow Appendix B and use the Ethernet Web Browser to observe <Operating Pressure Parameter (default value is 40). Increase value between 40-90 for control gains to be less aggressive.	MFC inlet pressure to high for default <Operating Pressure> parameter	Follow Appendix B and use the Ethernet Web Browser to observe <Operating Pressure Parameter (default value is 40). Increase value between 40-90 for control gains to be less aggressive.
	MFC nameplate gas not same as actual gas	Check that MFC active gas is the same as the nameplate gas using Ethernet Web Browser.	MFC nameplate gas not same as actual gas	Check that MFC active gas is the same as the nameplate gas using Ethernet Web Browser.
	MFC valve and control parameter setup	Contact MKS Service Center.	MFC valve and control parameter setup	Contact MKS Service Center.

6.3 Digital Communication Troubleshooting

6.3.1 DeviceNet

Table 24: DeviceNet Status LED

Network Status LED		Network LED Description
Solid Green	Link OK, On-line, Connected	The device is on-line and has connection in the established state.
		<ul style="list-style-type: none"> For a Group 2 only device it means that this device is not allocated to a master.
Flashing Green	On-line, Not Connected	Device is on-line but has no connection in the established state.
		<ul style="list-style-type: none"> The device has passed The Dup_MAC_ID test, is on-line, but has no established connections to other nodes. For a Group 2 only device it means that this device is not allocated to a master.
Red	Critical Link Failure	Failed communication device. The device has detected an error that has rendered it incapable of communicating on the network (Duplicate MAC ID, or Bus-off).
Flashing Red	Connection Time-Out	One or more I/O Connections are in the Timed-Out state.
Flashing Red & Green	Communication Faulted and Received an Identify Comm Fault Request - Long Protocol	A specific Communication Faulted device. The device has detected a Network Access error and is in the Communication Faulted state. The device has subsequently received and accepted an Identify Communication Faulted Request - Long Protocol message.
Off	Not Powered/Not On-Line	Device is not on-line.

Table 25: Module (MOD) LED

DeviceNet Module Status Indicator		MOD LED Description
Green	Device operational	The device is operating in a normal condition.
Flashing Green	Device in Standby (The Device Needs Commissioning)	The device needs commissioning due to configuration missing, incomplete or incorrect.
Red	Unrecoverable Fault	The device has an unrecoverable fault; may need replacing.
Flashing Red	Minor Fault	Recoverable Fault.
Flashing Red & Green	Device Self Testing	The Device is in Self Test. Reference the Identity Object in Volume II for Device states.
Off	No power	There is no power applied to the device.

Table 26: DeviceNet Connectivity

Device Not Establishing Network Connector	
Device has green MOD LED and Flashing Green NET LED	Polled Assembly Mismatch between Master and Slave MFC
	Baud Rate Mismatch
	EDS File for MFC Required and installed in Master Library
	Host Software not recognizing Identity Object Attributes (MFC model/ Firmware revision/ Vendor code). Use independent DNET Communications Tool to validate connectivity to MFC. If MFC fails to connect using local independent DeviceNet Diagnostic tool contact MKS Service.
	Bad Electronics. Use independent DNET Communications Tool to validate connectivity to Network. If unit fails to connect using independent DeviceNet diagnostic tool contact MKS Service.
	Bad DNET Cable

Device Not Establishing Network Connector

Device has green MOD LED and Solid Red NET LED	Duplicate MAC Node Address
--	----------------------------

6.3.2 RS485 Serial Communication

Table 27: RS485 LED Status

COMM LED Status	COMM LED Description
Dark	No power, check cable wiring to MFC.
Solid Amber	MFC Initialization successfully completed
Blinking Amber	Successful serial connection opened between host and MFC. MFC has replied to request from the Host. Note that the COMM LED is solid Amber if the host is not querying the MFC.
Error LED Status	Error LED Description
Dark	MFC initialization complete, no error detected
Solid Red	Critical Unrecoverable Fault. Contact MKS Service

Table 28: RS485 Connectivity

Device Not Establishing Serial Connection to HOST

Device has solid Amber COMM LED	<p>Compare set up of HOST with MFC serial communication parameters:</p> <table border="0"> <tr> <td>Parameter</td> <td>Value</td> </tr> <tr> <td>Start Bit</td> <td>1</td> </tr> <tr> <td>Data Bits</td> <td>8</td> </tr> <tr> <td>Parity</td> <td>no parity</td> </tr> <tr> <td>Stop Bit</td> <td>1</td> </tr> </table> <p>Baud Rate* 9,600 (initial); 19,200; 38,400 End-of-Line Delimiter semicolon (;)</p>	Parameter	Value	Start Bit	1	Data Bits	8	Parity	no parity	Stop Bit	1
	Parameter	Value									
Start Bit	1										
Data Bits	8										
Parity	no parity										
Stop Bit	1										
COMM Port is properly identified for the serial driver program.											

Device Not Establishing Serial Connection to HOST	
<i>Device has solid Amber COMM LED (continued)</i>	Verify the host is sending message to correct MAC Address.
	Verify the wiring of the serial to RS485 converter is half duplex (2 wire).
	Electronics failure related to damaged or blown digital signal transceivers.

6.3.3 Profibus Communication

Table 29: Profibus LED Status

Module (MOD) LED Status	MOD LED Description
Dark	No power, check cable wiring to MFC.
Solid Green	MFC initialized properly.
Solid Red	Unrecoverable Fault. Contact MKS Service.
Blinking Green	Wink On
Network LED Status	Network LED Description
Dark	No connection to Profibus Master and Network.
Blinking Green	Network connection is established between MFC and Profibus Master.

Table 30: Profibus Connectivity

Device Not Establishing Serial Connection to HOST/ Master	
Device has Dark NET LED	Master / Host not recognizing attributes of the MFC. Check that the correct GDS file was used when configuring the network.
	Verify pinout of communication signal lines for transmit and receive between Master and Slave MFC.
	Electronics Failure. Contact MKS Service.

6.3.4 Ethercat Communication

Table 31: Ethercat LED Status

LED Identification	LED Status	LED Description
PWR (Power)	Dark	No power to the Device.
	Solid Green	Power properly wired on connector pins.
RUN (Operation Status)	Dark	No communication has been established between Master and Slave.
		Master is communicating but the device is in an INIT mode.
	Blinking Green - 2 HZ	Device currently in PREOP mode.
	Blinking Green - Fast	Device in Bootstrap mode.
	Blinking Green - 1 Hz	Device in Safe OP mode. Device set to default safe mode (valve closed). Device will not respond to active commands.
	Solid Green	Device in OP mode and is fully functional.

LED Identification	LED Status	LED Description
Err (Error LED)	Dark	No communication issues detected.
	Blinking RED	Process data timeout.
		Process data configuration Error (Wrong ESI File being used).

Table 32: Ethercat Connectivity

Device Not Establishing Serial Connection to HOST/ Master	
Device has Dark RUN LED	Master / Host not recognizing attributes of the MFC. Check that the correct ESI file was used when configuring the network.
	Verify Ethernet In/ Out connections at the device are correct to promote process data exchange from Master to Device.
	If using Hubs and Switches in the network, verify operation at each point.
	Network card from computer not configured or defined by the MASTER.
	Verify Power LED is solid Green.
	Electronics Failure. Contact MKS Service.

6.3.5 Profinet Communication

Table 33: Profinet LED Status

LED Identification	LED Status	LED Description
Maintenance	Dark	Not used by MKS.
Bus Fault	Solid Red	Power on but no communication link between I/O controller and MFC.
	Blinking Red	MFC acknowledges I/O controller connection, but active communication link not established.
	Dark	Communication link has been established.
Ready	Dark	No power.
	Solid Green	Device Powered up or in combination with the bus fault is dark, I/O controller has establish communication.
System Fault	Dark	No communication or network issues.
	Red	Non recoverable MFC fault, contact MKS Service.

Table 34: Profinet Connectivity

Device Not Establishing Connection to I/O Controller	
Device has solid Green Ready LED and Solid Red Bus Fault LED	Duplicate MAC ID.
	Verify Ethernet In/ Out connections at the device are correct to promote process data exchange from I/O controller to Device.
	If using Hubs and Switches in the network, verify operation at each point.
	GSDML file not linked to Master to properly configure MFC.
	Electronics Failure. Contact MKS Service.

A. SEMI Gas Codes and MFC Flow Range Summary

6.4 G and I Series MFC Relationship with SEMI Gas Code Numbers

Gas codes, which are used to identify the model configuration, are in accordance with *SEMI Guideline E52, Practice for Referencing Gases and Gas Mixtures Used in Digital Mass Flow Controllers* for the G and I Series MFC.

MKS has designed a total of 13 flow body combinations for the G and I Series MFC products to cover the operating flow ranges between 5 to 50000 sccm full scale N2. Nitrogen is always used as the MFC manufacturing calibration gas.

The nameplate gas based on the SEMI guideline is described by a 3-digit code number assigned to each gas or gas mixture. The full scale flow range for a SEMI process gas is determined by the physical and thermodynamic properties of that specific gas with respect to nitrogen. This relationship provides a Full Scale Calculation Factor (FSCF), which acts as a guideline when determining the MFC model required for a particular application.

Here are a few examples of how the information in the following tables can be used as a guideline for determining if the G or I Series can be used in a given process design scenario:

- A process requires 80000 sccm of Ar. Can the G or I Series MFC be configured for this application?

Ar	004	1.39	13.9	69500
----	-----	------	------	-------

Based on the information in the table, the maximum full scale for Ar = 69500 sccm. To meet this flow requirement, a different MKS MFC designed for high flow applications would have to be used instead of a G or I Series MFC.

- A process requires the ability to control and flow 1 sccm of Ar.

Ar	004	1.39	13.9	69500
----	-----	------	------	-------

The lowest full scale range for Ar is 13.9. A 1 sccm set point is approximately 7% of the allowable full scale. The control range for the G and I Series MFC is 2-100% FS as defined in Table 1-3, page 6. Based on this information, a G or I Series MFC could be configured to meet this process flow requirement.

NOTE

If the gas or gas mixture is not included in the following summary table, contact MKS Applications Engineering for additional information.

Table 35: SEMI Process Gas Definition

Symbol	SEMI Gas Code #	Full Scale Calculation Factor	Full Scale Flow Range for SEMI Gas (sccm)	
He	001	1.4	14	70000
Ne	002	1.38	13.8	69000
Ar	004	1.39	13.9	69500
Kr	005	1.4	14	70000
Xe	006	0.6	6	30000
H ₂	007	1	10	50000
Air	008	1	10	50000
CO	009	1	10	50000
HBr	010	1	10	50000
HCl	011	1	10	50000
HF	012	1	10	50000
N ₂	013	1	10	50000
D ₂	014	1	10	50000
O ₂	015	1	10	50000
NO	016	1	10	50000
HI	017	1	10	50000
F ₂	018	0.91	9.1	45500
Cl ₂	019	0.84	8.4	42000
H ₂ S	022	0.86	8.6	43000
H ₂ Se	023	0.82	8.2	41000

Symbol	SEMI Gas Code #	Full Scale Calculation Factor	Full Scale Flow Range for SEMI Gas (sccm)	
CO2	025	0.76	7.6	38000
NO2	026	0.75	7.5	37500
N2O	027	0.73	7.3	36500
CH4	028	0.72	7.2	36000
NH3	029	0.73	7.3	36500
PH3	031	0.72	7.2	36000
SO2	032	0.7	7	35000
CH3F	033	0.74	7.4	37000
COS	034	0.67	6.7	33500
AsH3	035	0.69	6.9	34500
CH3Cl	036	0.65	6.5	32500
C2H4	038	0.62	6.2	31000
SiH4	039	0.6	6	30000
CS2	040	0.61	6.1	30500
OF2	041	0.64	6.4	32000
C2H2	042	0.62	6.2	31000
GeH4	043	0.56	5.6	28000
CH3Br	044	0.63	6.3	31500
BF3	048	0.55	5.5	27500
CHF3	049	0.5	5	25000
CH5N	052	0.52	5.2	26000

Symbol	SEMI Gas Code #	Full Scale Calculation Factor	Full Scale Flow Range for SEMI Gas (sccm)	
NF3	053	0.5	5	25000
C2H6	054	0.47	4.7	23500
C2H3Cl	055	0.49	4.9	24500
B2H6	058	0.41	4.1	20500
C3H6	061	0.44	4.4	22000
PF3	062	0.47	4.7	23500
CF4	063	0.42	4.2	21000
C2H2F2	064	0.45	4.5	22500
C3H4	066	0.45	4.5	22500
SiH2Cl2	067	0.4	4	20000
C3H6	069	0.41	4.1	20500
BCl3	070	0.41	4.1	20500
C2H6O	073	0.4	4	20000
ClF3	077	0.43	4.3	21500
C2H7N	085	0.38	3.8	19000
SF4	086	0.36	3.6	18000
SiF4	088	0.35	3.5	17500
C3H8	089	0.35	3.5	17500
Si2H6	097	0.34	3.4	17000
GeF4	099	0.32	3.2	16000
C4H6	100	0.32	3.2	16000

Symbol	SEMI Gas Code #	Full Scale Calculation Factor	Full Scale Flow Range for SEMI Gas (sccm)	
C2H3CIF2	103	0.32	3.2	16000
C4H8	106	0.28	2.8	14000
SiCl4	108	0.31	3.1	15500
SF6	110	0.26	2.6	13000
C4H10(i)	111	0.26	2.6	13000
C4H10(n)	117	0.26	2.6	13000
C2F6	118	0.24	2.4	12000
WF6	121	0.25	2.5	12500
MoF6	124	0.23	2.3	11500
C6H14	127	0.18	1.8	9000
C3F8	128	0.19	1.9	9500
C4F8	129	0.17	1.7	8500
C3H9BO3	131	0.2	2	10000
C3F6	138	0.22	2.2	11000
NOCl	141	0.64	6.4	32000
SiHCl3	147	0.37	3.7	18500
C2HF5	155	0.28	2.8	14000
C2H2F4	156	0.3	3	15000
T2	159	1	10	50000
HNO3	167	0.5	5	25000
C2H3N	173	0.51	5.1	25500

Symbol	SEMI Gas Code #	Full Scale Calculation Factor	Full Scale Flow Range for SEMI Gas (sccm)	
CH4O	176	0.6	6	30000
C8H10	179	0.16	1.6	8000
C7H8	181	0.23	2.3	11500
CH3Cl3Si	183	0.27	2.7	13500
C3H6O	184	0.35	3.5	17500
CH6Si	185	0.4	4	20000
C6H6	197	0.29	2.9	14500
CBr4	200	0.25	2.5	12500
SiH3Cl	205	0.52	5.2	26000
C6H18Si2O	228	0.1	1	5000
C5H12	231	0.21	2.1	10500
C4F8	236	0.27	2.7	13500
C4F10	241	0.14	1.4	7000
C4H12Si	251	0.17	1.7	8500
C5F8	266	0.19	1.9	9500
C3H2F6	267	0.21	2.1	10500
CH2O	322	0.78	7.8	39000
CH3I	323	0.6	6	30000
NG	357	0.73	7.3	36500

Table 36: Standard SEMI Gas Mixtures

Symbol / Gas Mixture	SEMI Gas Code #	Full Scale Calculation Factor	Full Scale Flow Range for SEMI Gas (sccm)	
15% PH ₃ / N ₂	500	1	10	50000
5% PH ₃ / N ₂	501	1	10	50000
10% H ₂ Se/ H ₂	511	1	10	50000
20% O ₂ / CF ₄	513	0.49	4.9	24500
1% PH ₃ / N ₂	514	1	10	50000
1% (CH ₃ O) ₃ B/ H ₂	526	0.93	9.3	46500
20% SiH ₄ / He	529	1.09	10.9	54500
1% PH ₃ / SiH ₄	531	0.62	6.2	31000
10% H ₂ / N ₂	532	1	10	50000
1.5% PH ₃ / SiH ₄	533	0.62	6.2	31000
3% PH ₃ / Ar	534	1.36	13.6	68000
20% O ₂ / He	536	1.26	12.6	63000
10% PH ₃ / Ar	538	1.29	12.9	64500
5% H ₂ / N ₂	542	1	10	50000
0.01% B ₂ H ₆ / H ₂	547	1	10	50000
0.8% PH ₃ / N ₂	552	1	10	50000
1% B ₂ H ₆ / N ₂	558	1	10	50000
1% H ₂ / N ₂	561	1	10	50000
1% O ₂ / N ₂	562	1	10	50000
1% PH ₃ / H ₂	563	1	10	50000

Symbol / Gas Mixture	SEMI Gas Code #	Full Scale Calculation Factor	Full Scale Flow Range for SEMI Gas (sccm)	
10% SiH ₄ / Ar	565	1.25	12.5	62500
10% O ₃ / O ₂	571	0.94	9.4	47000
10% SiH ₄ / He	573	1.21	12.1	60500
15% PH ₃ / SiH ₄	584	0.62	6.2	31000
2% H ₂ / N ₂	588	1	10	50000
2% SiH ₄ / He	589	1.32	13.2	66000
20% PH ₃ / H ₂	593	0.92	9.2	46000
21% O ₂ / N ₂	594	1	10	50000
30% He/ O ₂	603	1	10	50000
30% O ₂ / He	604	1.21	12.1	60500
4% H ₂ / N ₂	607	1	10	50000
5% H ₂ / Ar	619	1.37	13.7	68500
5% O ₂ / Ar	623	1.37	13.7	68500
5% SiH ₄ / Ar	629	1.32	13.2	66000
50% N ₂ / O ₂	631	1	10	50000
15% O ₃ / O ₂	641	0.92	9.2	46000
10% O ₂ / He	649	1.3	13	65000
15% NO/ N ₂	652	1	10	50000
2% SiH ₄ / N ₂	653	1	10	50000
5% B ₂ H ₆ / N ₂	654	0.93	9.3	46500
0.8% B ₂ H ₆ /N ₂	662	1	10	50000

Symbol / Gas Mixture	SEMI Gas Code #	Full Scale Calculation Factor	Full Scale Flow Range for SEMI Gas (sccm)	
5% PH ₃ / He	693	1.3	13	65000
10% GeH ₄ / Ar	698	1.22	12.2	61000
5% CH ₄ / He	699	1.3	13	65000
5% PH ₃ /H ₂	709	1	10	50000
10% CH ₄ / Ar	710	1.29	12.9	64500
5% B ₂ H ₆ / H ₂	722	0.91	9.1	45500
8% H ₂ / N ₂	727	1	10	50000
20% O ₂ / N ₂	736	1	10	50000
5% B ₂ H ₆ / He	766	1.21	12.1	60500
5% SiH ₄ / N ₂	773	1	10	50000
5% SiH ₄ / He	780	1.27	12.7	63500
1% SO ₂ / N ₂	782	1	10	50000
0.1% PH ₃ / N ₂	789	1	10	50000
0.1% PH ₃ / H ₂	793	1	10	50000
10% CO ₂ / Ar	813	1.29	12.9	64500
15% SiH ₄ / Ar	821	1.16	11.6	58000
2% NO/ N ₂	822	1	10	50000
2% SiH ₄ / Ar	823	1.28	12.8	64000
3% NH ₃ / N ₂	831	1	10	50000
3% H ₂ / Ar	833	1.39	13.9	69500
5% NH ₃ / N ₂	843	1	10	50000

Symbol / Gas Mixture	SEMI Gas Code #	Full Scale Calculation Factor	Full Scale Flow Range for SEMI Gas (sccm)	
5% CO/ N2	862	1	10	50000
2% O2/ Ar	863	1.39	13.9	69500
3% SiH4/ H2	870	1	10	50000
20% O2/ Ar	875	1.29	12.9	64500
10% B2H6/ Ar	881	1.12	11.2	56000
10% AsH3/ N2	907	1	10	50000
2% PH3/ H2	916	1	10	50000
10% NO/ N2	924	1	10	50000
2% GeH4/ H2	938	1	10	50000
10% H2S/ H2	942	1	10	50000
40% H2/ N2	943	1	10	50000
1%NO/ N2	945	1	10	50000
10% H2/ He	950	1.3	13	65000
10% H2/ Ar	955	1.35	13.5	67500
5% O2/ N2	960	1	10	50000
20% F2/ N2	963	1	10	50000
2% (CH3O)3B/ H2	966	0.9	9	45000
5% NO2/ N2	972	1	10	50000
2% H2/ Ar	973	1.39	13.9	69500
20% GeH4/ H2	978	0.86	8.6	43000
1% HCl/ N2	990	1	10	50000

Symbol / Gas Mixture	SEMI Gas Code #	Full Scale Calculation Factor	Full Scale Flow Range for SEMI Gas (sccm)	
5% C3H6/ N2	995	1	10	50000

Table 37: Non Standard Gas Mixtures

Symbol / Gas Mixture	Gas Code #	Full Scale Calculation Factor	Full Scale Flow Range for SEMI Gas (sccm)	
40% SiCl4/ O2	9037	0.53	5.3	26500
15% O2/ Ar	9045	1.32	13.2	66000
10% CO/ N2	9047	1	10	50000
10% Ar/ He	9049	1.36	13.6	68000
2% B2H6/ H2	9050	0.94	9.4	47000
50% He/ C2H6	9051	0.73	7.3	36500
10% C2H2/ Ar	9052	1.25	12.5	62500
8% CO2/ Ar	9053	1.31	13.1	65500
35% CO2/ CH4	9054	0.75	7.5	37500
25% N2/ H2	9055	1	10	50000
6% PH3/ H2	9057	0.95	9.5	47500
10% Cl2/ N2	9058	1	10	50000
3% NO/ N2	9059	1	10	50000
3% NO2/ N2	9060	1	10	50000
5% O2/ CO2	9061	0.75	7.5	37500
10% SO2/ Air	9062	1	10	50000

Symbol / Gas Mixture	Gas Code #	Full Scale Calculation Factor	Full Scale Flow Range for SEMI Gas (sccm)	
0.1% SO ₂ / Air	9063	1	10	50000
Custom9064	9064	0.72	7.2	36000
Custom9065	9065	0.71	7.1	35500
35 PH ₃ / H ₂	9067	1	10	50000
35 (CH ₃ O) ₃ B/ H ₂	9068	0.87	8.7	43500
1% CO/ N ₂	9069	1	10	50000
1% NH ₃ / N ₂	9070	1	10	50000
1% C ₃ H ₈ / N ₂	9071	1	10	50000
50% C ₄ H ₁₀ / N ₂	9072	0.41	4.1	20500
13.3% O ₃ / O ₂	9073	0.93	9.3	46500
1% C ₃ H ₈ / 2% C ₃ H ₆ / N ₂	9074	1	10	50000
30% HCl/ N ₂	9075	1	10	50000
25% B ₂ H ₆ / H ₂	9076	0.73	7.3	36500
8.5% CF ₄ / O ₂	9077	0.89	8.9	44500
9.35 O ₃ / O ₂	9078	0.95	9.5	47500
(CH ₂) ₅	9079	0.29	2.9	14500
25% C ₃ H ₉ Ga/ H ₂	9080	0.56	5.6	28000
0.25 % C ₃ H ₉ In/ H ₂	9081	1	10	50000
1% BCl ₃ / He	9082	1.33	13.3	66500
10% SiCl ₄ / N ₂	9083	0.82	8.2	41000
5% C ₂ H ₆ / N ₂	9084	0.95	9.5	47500

Symbol / Gas Mixture	Gas Code #	Full Scale Calculation Factor	Full Scale Flow Range for SEMI Gas (sccm)	
5% C3H8/ N2	9085	0.91	9.1	45500
5% iso-C5H12/ N2	9086	0.84	8.4	42000
5% C5H12/ N2	9087	0.84	8.4	42000
5%_neo-C5H12/ N2	9088	0.84	8.4	42000
1% C6H14/ N2	9089	1	10	50000
205 C4H8/ N2	9090	0.68	6.8	34000
20% trans-2-C4H8/N2	9091	0.68	6.8	34000
20%_cis-2-C4H8/N2	9092	0.7	7	35000
20%_iso-C4H8/N2	9093	0.67	6.7	33500
5.1% H2S/ N2	9094	1	10	50000
1% C6H12/ N2	9095	1	10	50000
5.93% C2H2/ N2	9096	1	10	50000
5% NO/ He	9097	1.33	13.3	66500
30% H2/ N2	9099	1	10	50000
10% NH3/ He	9100	1.26	12.6	63000
10% Cl2/ He	9101	1.28	12.8	64000
1% Cl2/ He	9102	1.35	13.5	67500
2% B2H6/ He	9103	1.29	12.9	64500
25% SiH4/ H2	9104	0.85	8.5	42500
Custom9105	9105	0.72	7.2	36000
Custom9106	9106	0.7	7	35000

Symbol / Gas Mixture	Gas Code #	Full Scale Calculation Factor	Full Scale Flow Range for SEMI Gas (sccm)	
Custom9107	9107	0.63	6.3	31500
Custom9108	9108	0.33	3.3	16500
C3H2ClF3	9109	0.26	2.6	13000
0.5% B2H6/H2	9110	1	10	50000
5% NO/ N2	9111	1	10	50000
1% AsH3/ He	9112	1.34	13.4	67000
Custom9113	9113	0.43	4.3	21500
Custom9114	9114	0.6	6	30000
Custom9115	9115	0.75	7.5	37500
Custom9116	9116	0.46	4.6	23000
Custom9117	9117	0.63	6.3	31500
Custom9118	9118	0.77	7.7	38500
25_He/N2	9119	1	10	50000
8% SO2/ 13% O2/ N2	9120	1	10	50000
0.6% C3H8/ 2.4% C3H6/ N2	9122	1	10	50000
C3H7NH2	9123	0.26	2.6	13000
3.5% Ar/ Ne	9124	1.37	13.7	68500
0.05% Xe/ 3.5% Ar/ Ne	9125	1.37	13.7	68500
3% CH4/ N2	9126	1	10	50000
25% H2/ CO	9127	1	10	50000

Symbol / Gas Mixture	Gas Code #	Full Scale Calculation Factor	Full Scale Flow Range for SEMI Gas (sccm)	
10% Ar/ O2	9128	1	10	50000
4% H2S/ N2	9129	1	10	50000
5% C3H9N/ N2	9131	0.88	8.8	44000
5% C2H4O/ N2	9132	1	10	50000
Custom9133	9133	1	10	50000
2.25% He/ B2H6	9135	0.42	4.2	21000
2.25% He/ PH3	9136	0.75	7.5	37500
0.5% He/ O2	9137	1	10	50000

B. MFC Web Browser

The Web browser that is accessible via the Ethernet (RJ-45) connector on the side of the MFC provides the user with in-situ ability to setup, change configurations, and troubleshoot device functionality. The purpose of this appendix is to provide basic instructions on:

- Establishing communications between a computer and the MFC
- Monitor Mode versus Setup Mode
- Basic MFC functionality associated with the Setup Mode
- Setting up the phone <Plot> page for plotting and saving data

NOTE

Additional detailed information is available in a browser tutorial document created by MKS Engineering. Contact MKS Applications Engineering for a copy of this document.

Communicating with the MFC via Ethernet

1. Connect an Ethernet cable between the MFC and the computer or laptop that is going to be used to communicate to the device.
2. Open the **Control Panel** on the Startup menu.
3. Select Network and Sharing Center.
4. View the active networks on the laptop.

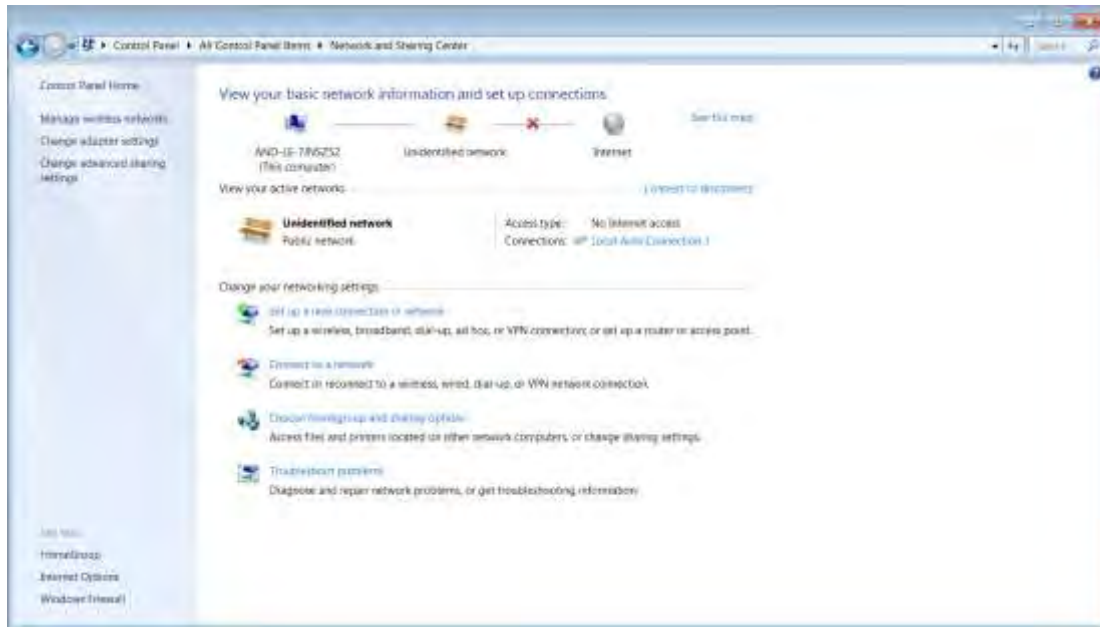

Figure 15: Basic Network Information

5. Double-click on the local area connection to open.



Figure 16: Local Area Connection Status

6. Select **Properties**. Scroll down to find and highlight **Internet Protocol Version 4**.

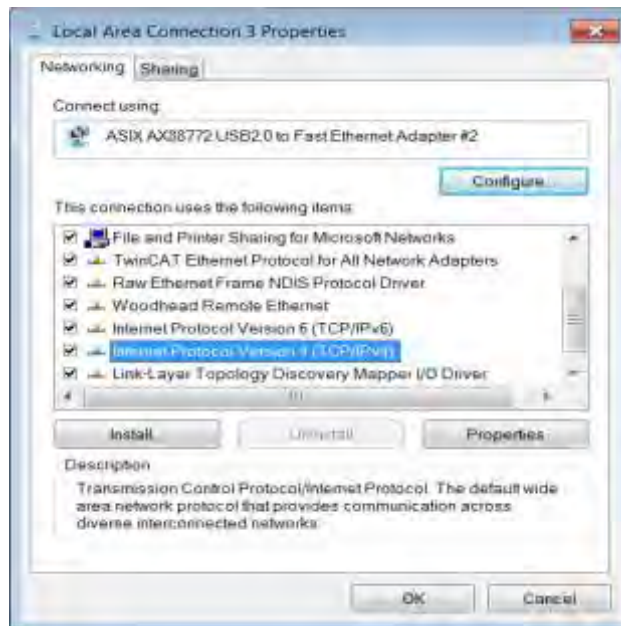

Figure 17: Internet Protocol Version 4

7. Select **Properties**.

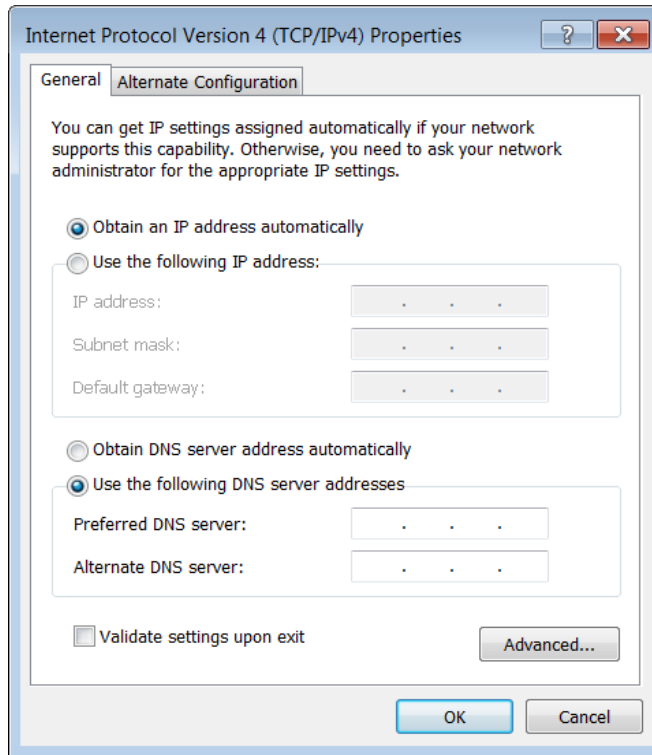

Figure 18: Properties

8. Select **Use the following IP Address**. Enter a unique IP address for the computer in the format shown below. Press the Tab key on the computer to populate the Subnet mask.

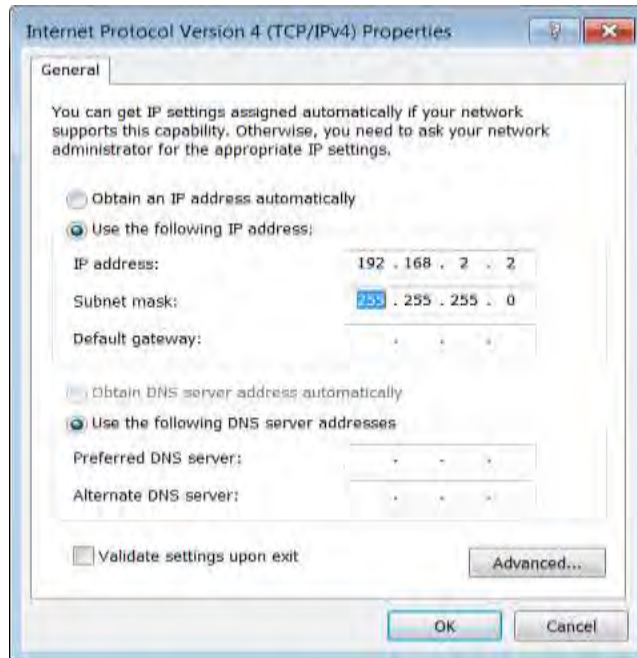

Figure 19: IP Settings

9. Click **OK** to select and close the window.
10. Once the address has been updated, close the remaining network connection windows.

The laptop is ready for Ethernet communication with MKS MFC devices.

Opening the Web Browser – Monitor Mode

1. Open Internet Explorer window.

NOTE

MKS recommends using Internet Explorer Version 11 to open the Web Browser.

2. Enter the IP address of the device.
192.168.2.155 is the factory default address for the G and I Series MFC.

When the Web browser opens, it shows the Device page and it is in the Monitor Mode.

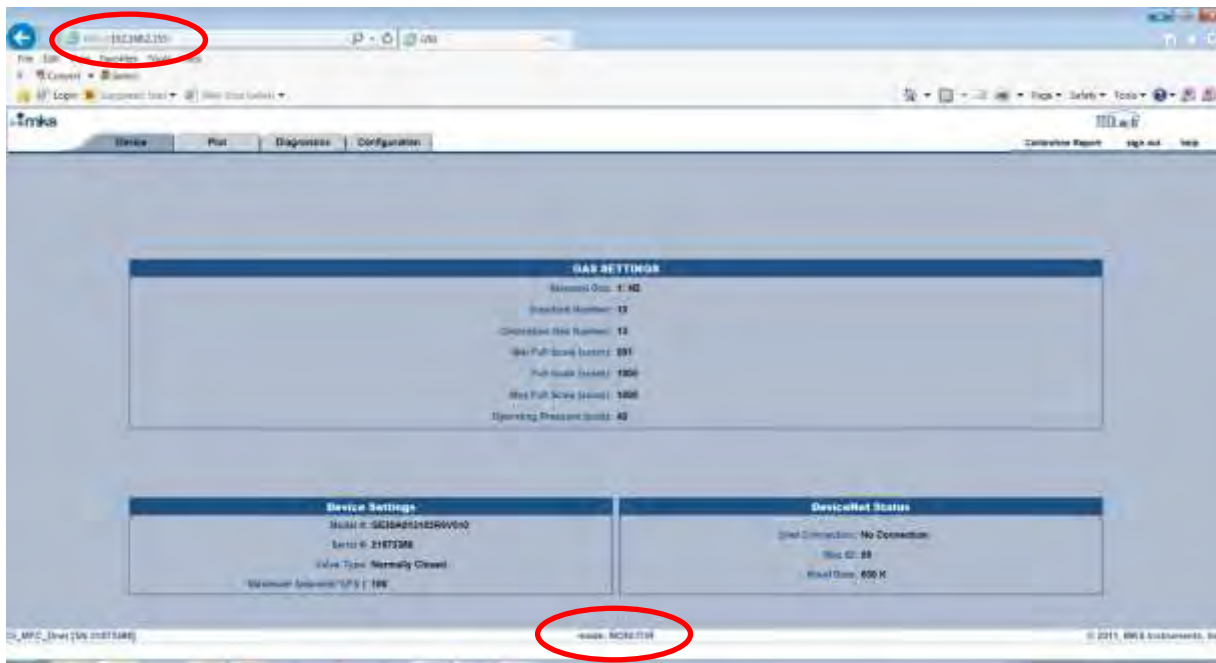

Figure 20: Device Page in Monitor Mode

The Monitor Mode Device tab displays the current setup of the device:

- Gas Setting – Selected Gas, Min and Max Full Scale Flow
- Device Settings – Model Code and Serial Number

Going to the Setup Mode

The Setup Mode allows for the user to access and make changes to a variety of Device features by opening the tabs located at the top of the page. The Setup Mode is accessed from the Configuration tab by entering a password in the Enter Password to Change Settings field.

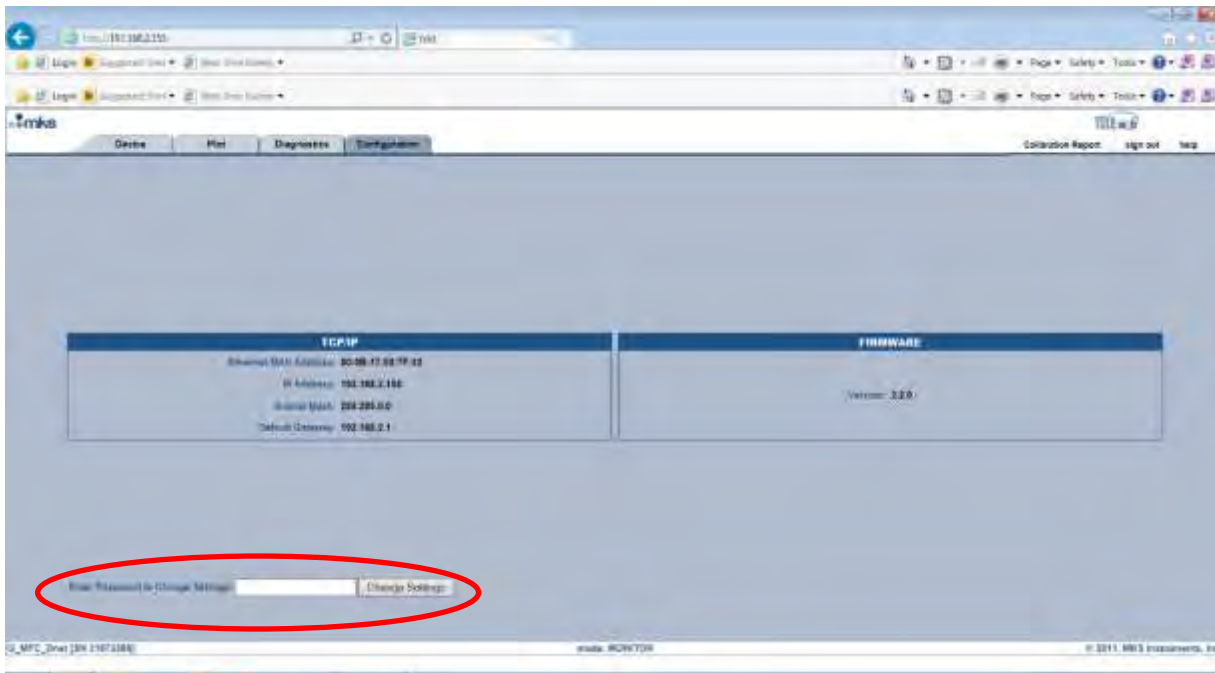

Figure 21: Enter Password to Change Settings

NOTE

The password to change from a Monitor to the Setup mode is config.

Once the password has been entered additional page tabs and active fields within the various Web browser pages allow the user to configure the MFC to a specific application.

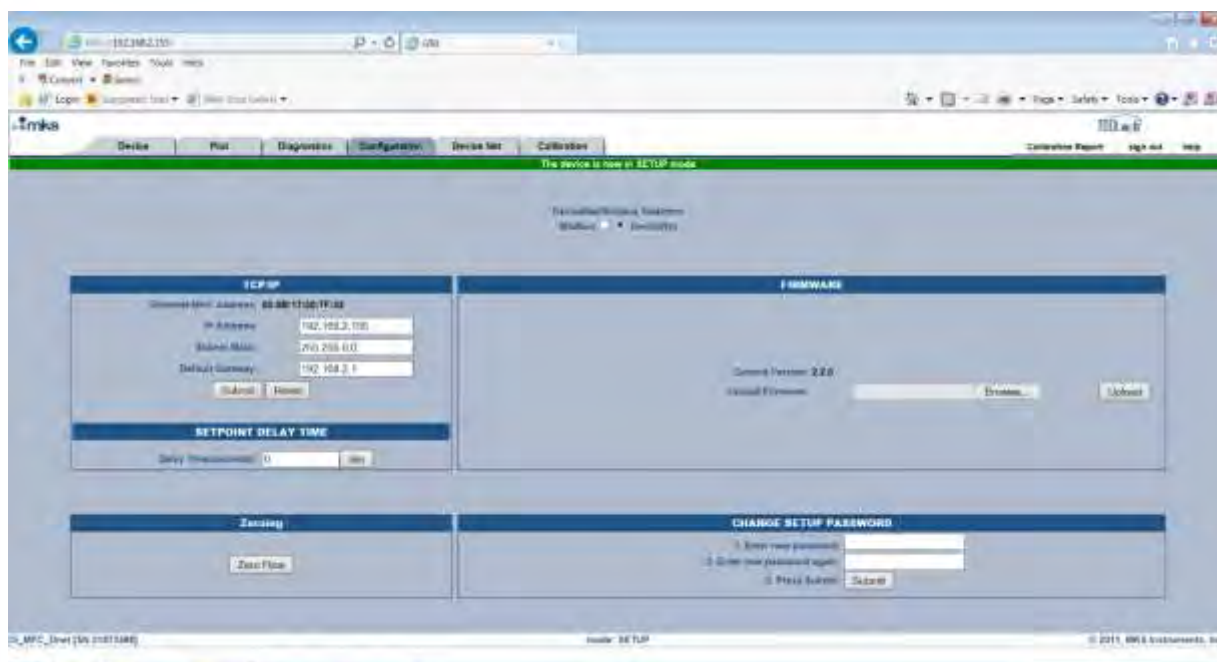

Figure 22: Additional Tabs

The table below describes basic features that can be configured via the Web browser for all G and I Series MFCs in the Setup Mode.

Table 38: Basic Features in the Setup Mode

MFC Function	Browser Tab	MFC I/O Type
Create a new gas	Device	All MFC Models
Re-range Full Scale	Device	All MFC Models
Select an existing gas table	Device	All MFC Models
Change MFC IP address	Configuration	All MFC Models
Change the firmware version	Configuration	All MFC Models
Set a set point delay time	Configuration	All MFC Models
Zero the MFC	Configuration	All MFC Models
Change the setup password	Configuration	All MFC Models

MFC Function	Browser Tab	MFC I/O Type
Modbus Mode	Configuration	All MFC Models, except EtherCAT and Profinet
Change unit type	Device	9 pin / 15 pin / 4 to 20 mA
Set ramp rate	Configuration	9 pin / 15 pin / 4 to 20 mA
Set point offset (% FS)	Configuration	9 pin / 15 pin
Optional input control	Optional Input	15 pin
Select baud rate	RS485	RS485
Select MAC address	RS485	RS485

Utilizing the Plot Page and Saving Data

As described in the following sections, four steps must be completed to be able to actively plot selected MFC parameters:

1. Create a special folder called ToolWeb in the computers local C drive.
2. Download the latest version of Java from java.com Web site.
3. Before being able to successfully save data to the ToolWeb folder, place a special Java policy document into a Java security folder located on the C drive.
4. Configure the IP Address of the MFC as a “Trusted” site in order to be able to run the Java applet for the plot page.

ToolWeb Folder

5. Open the C drive on the computer.
6. Right-click and open a new folder.
7. Rename the new folder as ToolWeb. This is the folder where all data collected will be saved.

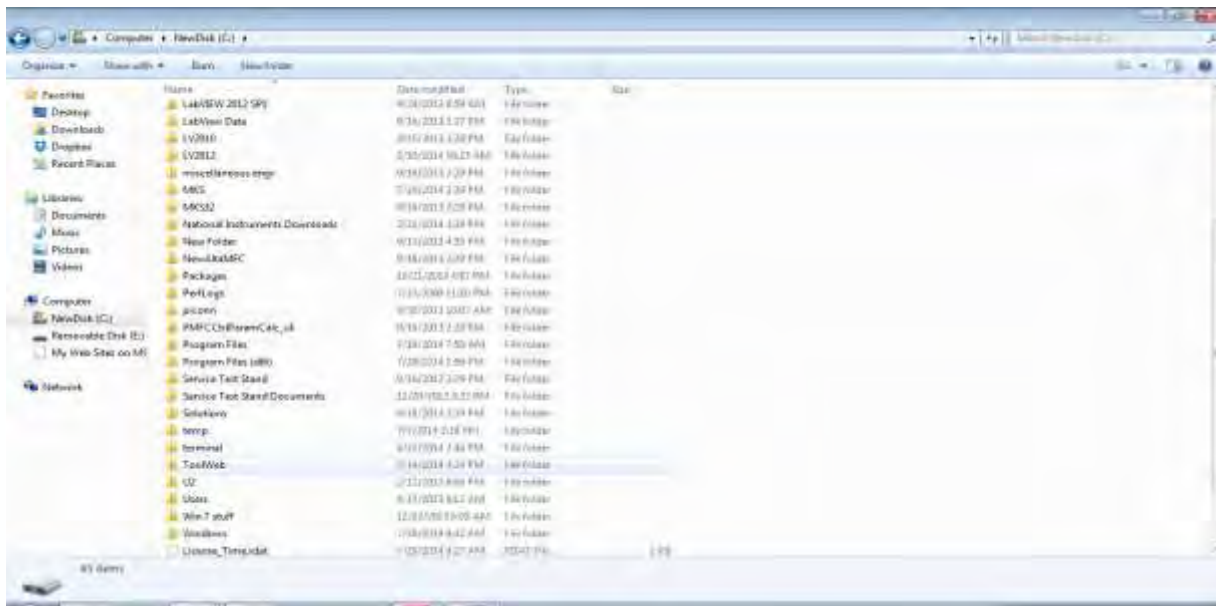

Figure 23: ToolWeb Folder

Downloading Java from java.com

7. Go online to java.com and download the latest version available on the Java Web site.



Figure 24: Java Web Site

Placing the java.policy in the C:drive Java Folder

A special version of the security document java.policy has been modified to allow permission to “write” to the ToolWeb folder. This document must be placed in the security folder of the Java folder located on the C drive of the computer.

8. Locate the Java folder that was just downloaded to the computer.

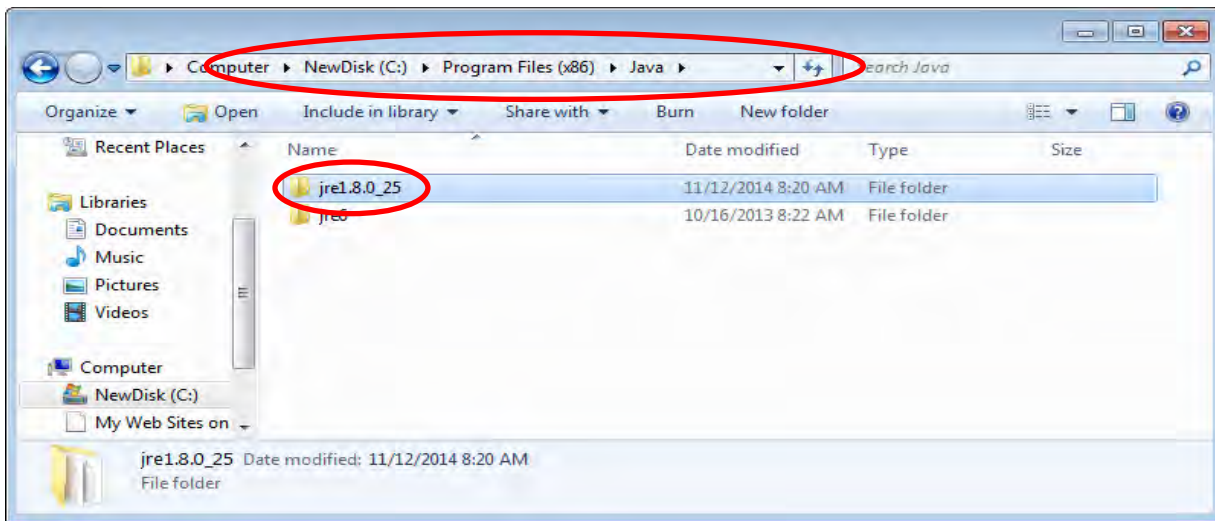

Figure 25: Java Folder from Download

9. Open the folder and follow the path to the security folder.

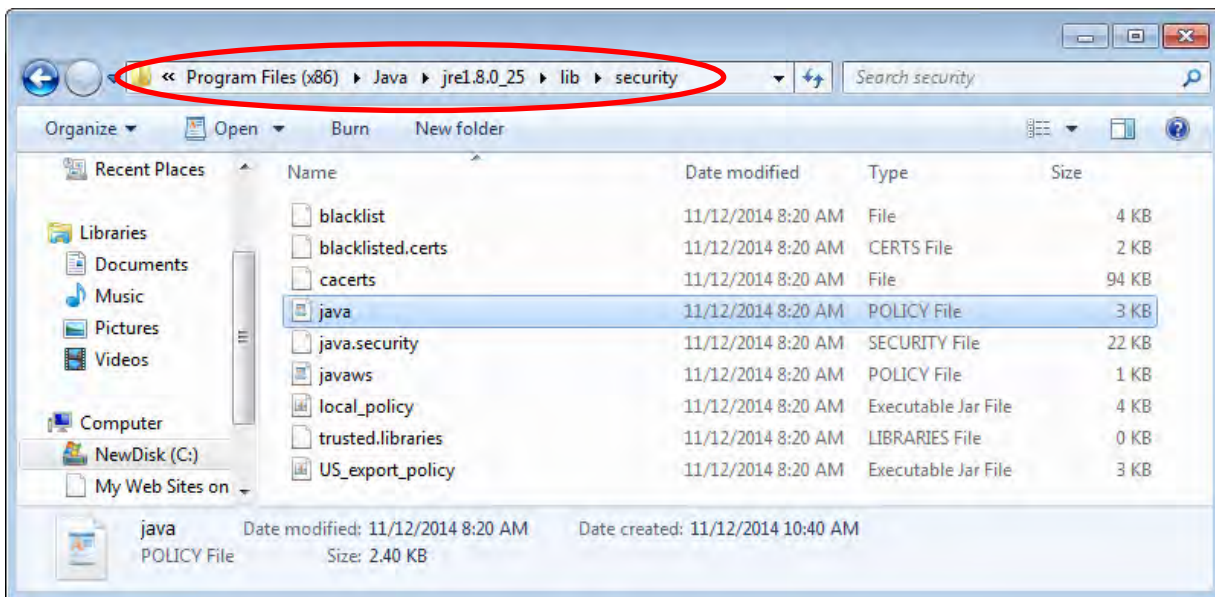

Figure 26: Security Folder

10. Locate the new Java policy security document (supplied by MKS) and drop it into the Java security folder.

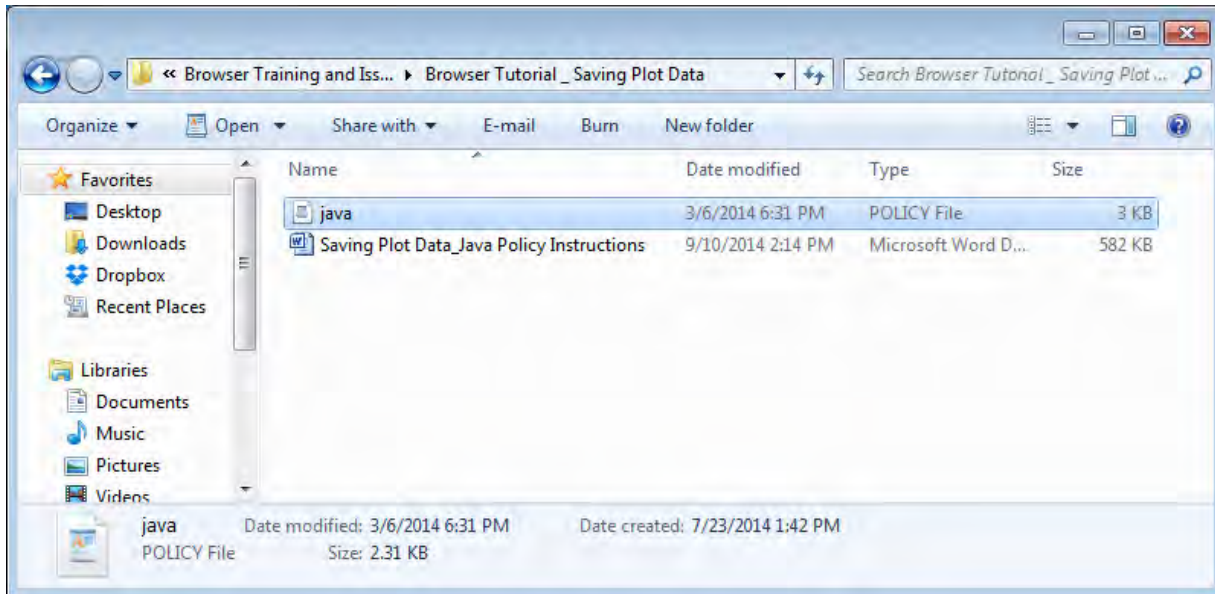

Figure 27: Java Policy Security Document in the Security Folder

NOTE

If you do not want to overwrite the original java.policy file, change the name of the original file to java_old (as shown in the example below) to keep both files.

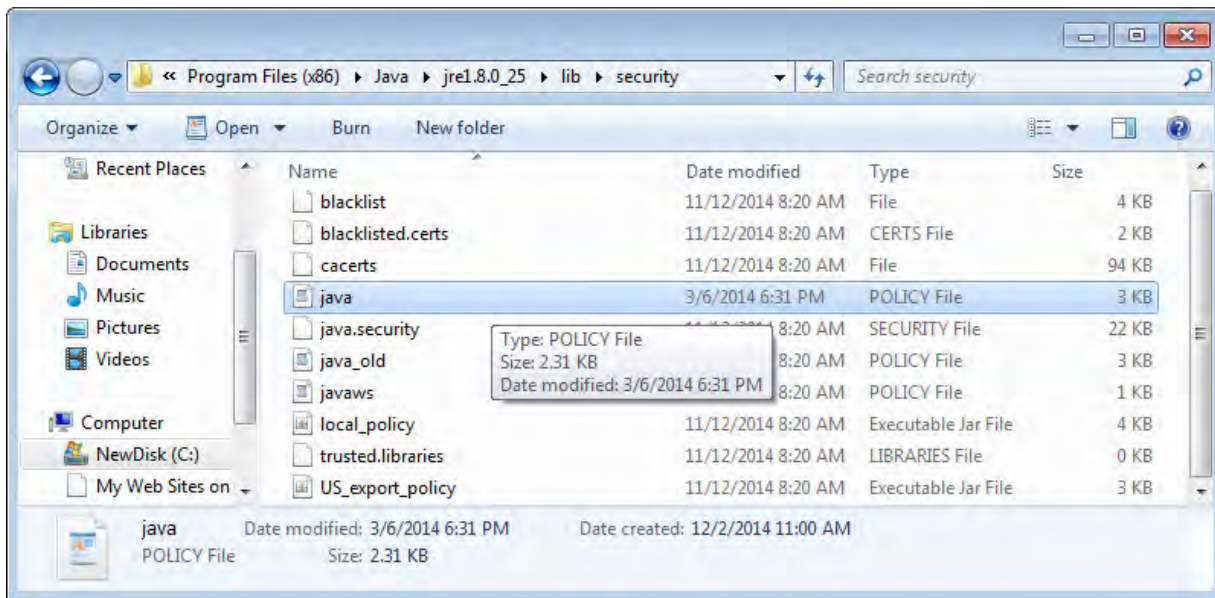

Figure 28: Java Policy Security Document

Creating a Java Security Trusted Site

11. Locate the Java folder in the Programs listing.



Figure 29: Java Folder

12. Select **Configure Java**.

13. Go to the Security tab.

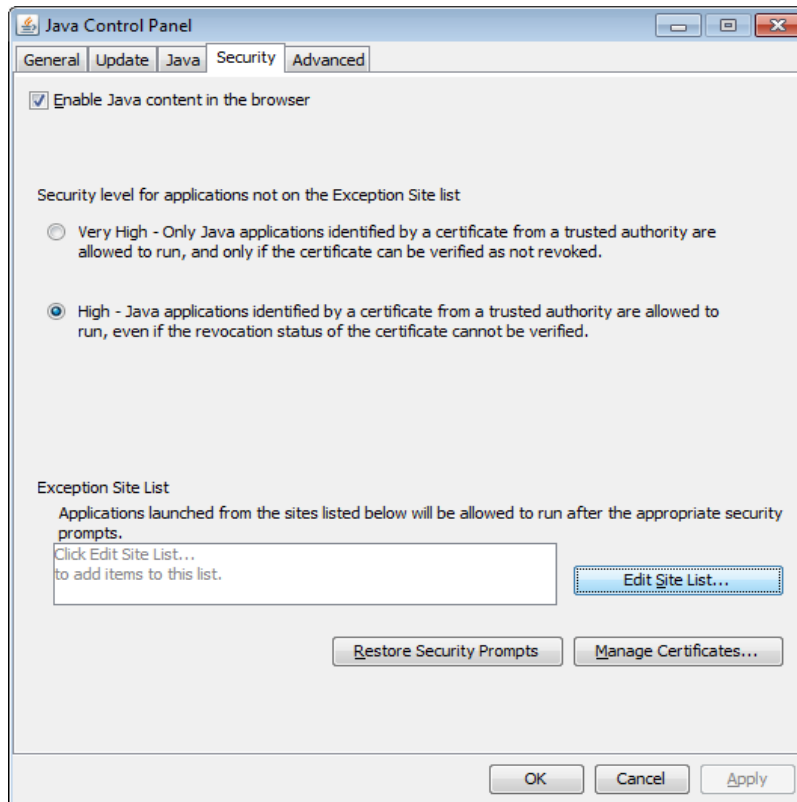

Figure 30: Security Tab

14. Click the **Edit Sites List** button.

15. Click **Add** and enter the IP address of the MFC. Click **OK** to save it to the Exception Site List.

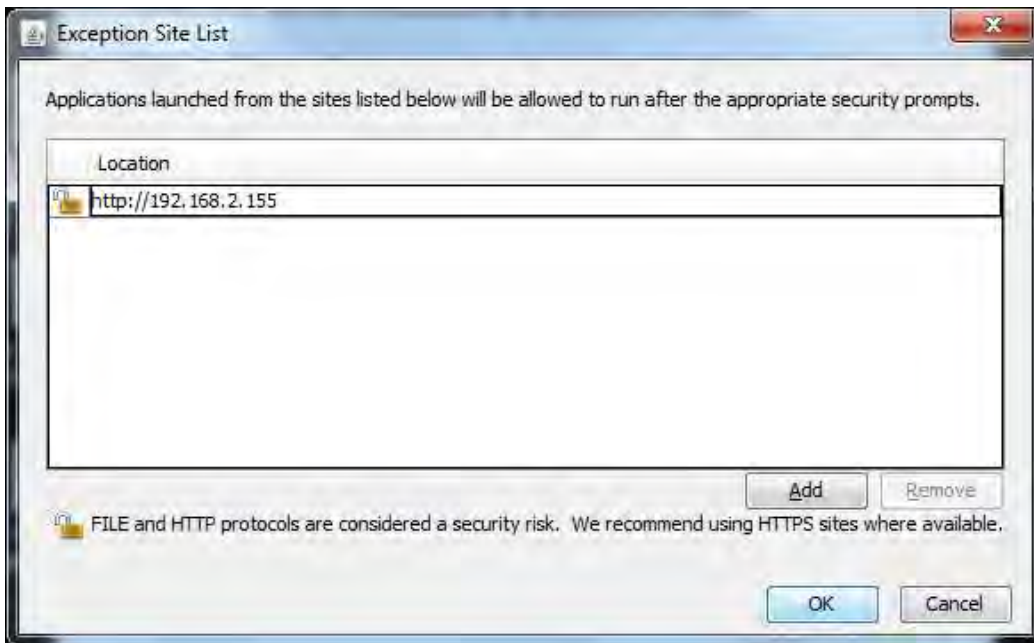

Figure 31: Exception Site List

16. When you see a Security Warning, click **Continue** and then **OK** to close the Edit List window.



Figure 32: Security Warning

17. Click **OK** to close the Security window.

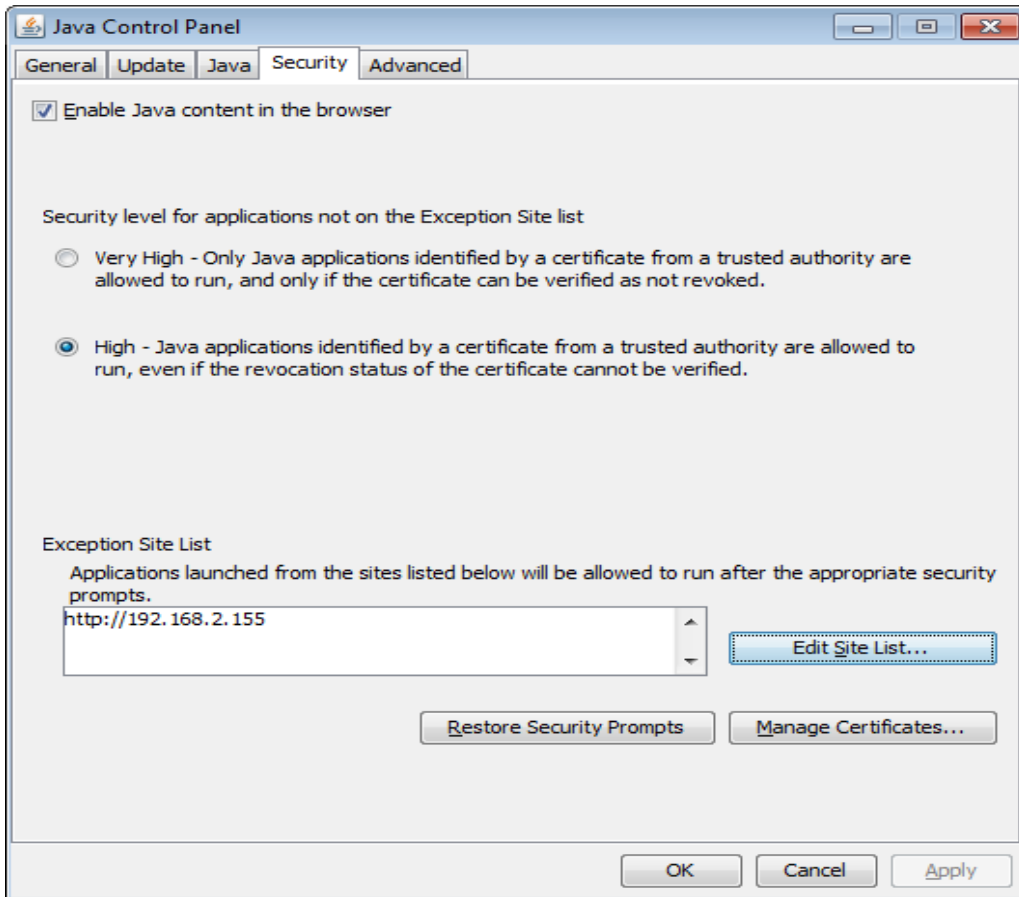

Figure 33: Security Window

NOTE

After completing all steps in this section, close the Web browser and re-launch Internet Explorer. Re-open the Web browser, select the Plot tab, and provide permission to run the Java applet for the Plot function.

If a security pop-up message denying access persists, close all applications and re-boot the computer before trying to open the Plot page of the Web browser.

C. Electrical Cables and Accessories

An analog G and I Series MFC should have both signal commons and the power common grounded together in order to minimize noise on the flow output signal and avoid potential analog signal offsets between set point and flow output. Tying these signal commons together can be done at:

- Power supply / I/O signal source
- Inside the cable, as noted in the table below
- Inside the MFC by selecting product code M (15-pin) or L (9-pin) when configuring the MFC

NOTE

MKS recommends a close examination of any existing electrical connections between the power supply / I/O signal source, cabling, and MFC prior to configuring a MKS MFC product as a replacement for existing process technology. Contact MKS Applications Engineering for additional assistance.

Table 39: Analog Power and Signal I/O Cables

Cable Number	MFC Connector	Other Connector	Similar to	Notes, Description
RCBDMFC-1	15 pin D subFemale	15 pin D male	CB259-5	Commons are tied at non-MFC end. No connections to valve open or close.
RCBDMFC-2	15 pin D sub Female	Flying leads	CB259-6	Commons are tied at MFC end. No wires allocated for valve open or close.
RCBDMFC-3	9 pin D sub Female	15 pin D male	CB147-12	Commons are tied at non-MFC end. No connections to valve open or close.
RCBDMFC-4	15 pin D sub Female	15 pin D male	CB147-1	Commons are tied at non-MFC end. Connections to valve open and close.

Cable Number	MFC Connector	Other Connector	Similar to	Notes, Description
RCBDMFC-5	15 pin D sub Female	Flying leads	(none)	4-20 mA connections. All grounds are separate.

D. IP Rating for the I Series MFC and What It Means

The I-series MFC has passed independent IP66 testing, so the question is:

What level of protection would that provide for the MFC in a harsh or demanding process environment?

The IP Code (or International Protection Rating, sometimes also interpreted as Ingress Protection Rating) consists of the letters IP followed by two digits and an optional letter. As defined in international standard IEC 60529, it classifies the degrees of protection provided against the intrusion of solid objects (such as dust) and water into a sealed enclosure. The standard aims to provide users more detailed information rather than vague marketing terms, such as waterproof.

The first digit indicates the level of protection that the enclosure provides against the ingress of solid foreign objects.

6 Dust Tight No ingress of dust; complete protection against contact.

To pass IP6X Dust Test Category 1, a vacuum was pulled on the interior of the MFC enclosure. The MFC was exposed to 2 kg/m³ of circulating talc for 3 minutes.

The second digit indicates the level of protection inside the enclosure against harmful ingress of water.

6 Powerful water jets Water projected in powerful jets (12.5mm nozzle) against the enclosure from any direction shall have no harmful effects.

To pass IPX6 Spray Test, the MFC was subjected to a high force water jet impinging on all sides of the MFC at a rate of 100 l/min for 3 minutes.

E. Modbus Operation

Enabling Modbus TCP/IP Control

G and I Series MFCs have the option of being controlled digitally over Modbus TCP/IP. Before an MFC can be operated using the Modbus LabView library, the secondary Modbus control system must be enabled from the Configuration page of the Web browser.

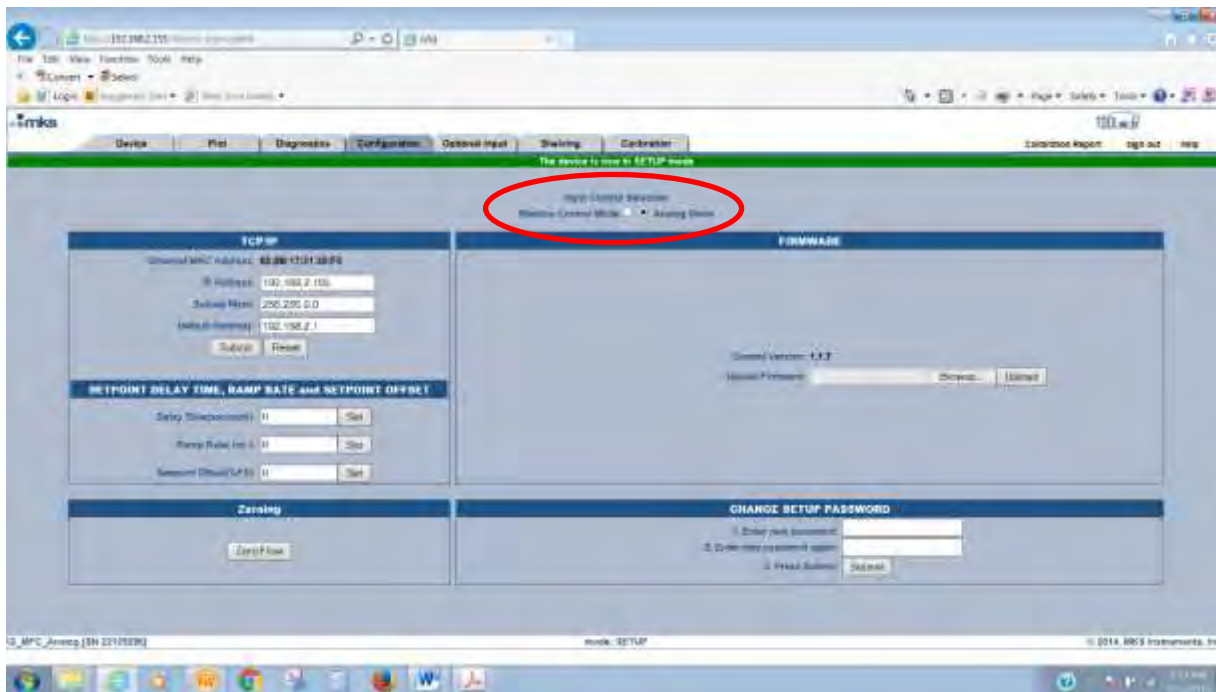

Figure 34: Configuration Page

Modbus Labview Library

MKS has created a Modbus LabView library that consists of a series of individual LabView virtual instruments (VIs) that can be used to connect to, communicate with, and control an MKS MFC of any interface type. In addition, as part of this Modbus Library, MKS has built a basic Modbus VI that provides an example of how the sub-VI's can be designed for MFC Modbus operation.

NOTE

To get full benefit of the Modbus LabView library, a National Instruments LabView application development system is required. Without a National Instruments LabView application development system, only the executable example VI is accessible for control of the MFC. Contact MKS Applications Engineering to obtain the Modbus LabView Library file information.

NOTE

MKS created these files for customers who are knowledgeable with regards to Modbus and are experienced programmers in LabView. MKS does not provide any additional technical LabView programming support for this application.

MKS Example VI

The example Modbus VI is a basic LabView program that provides communication and control of basic G and I Series functionality, including:

- Exhibit MFC identity parameters
- Ability to send set point and read back flow
- Ability to graph set point and flow
- Valve override open and close
- Zero flow

To access and launch the VI, the laptop or computer must have installed either a National Instruments 2011 Runtime Engine (can be downloaded from the National Instruments Web Site) or a version of the LabView development system from 2011 or later.

1. Enable Modbus from the Configuration page.

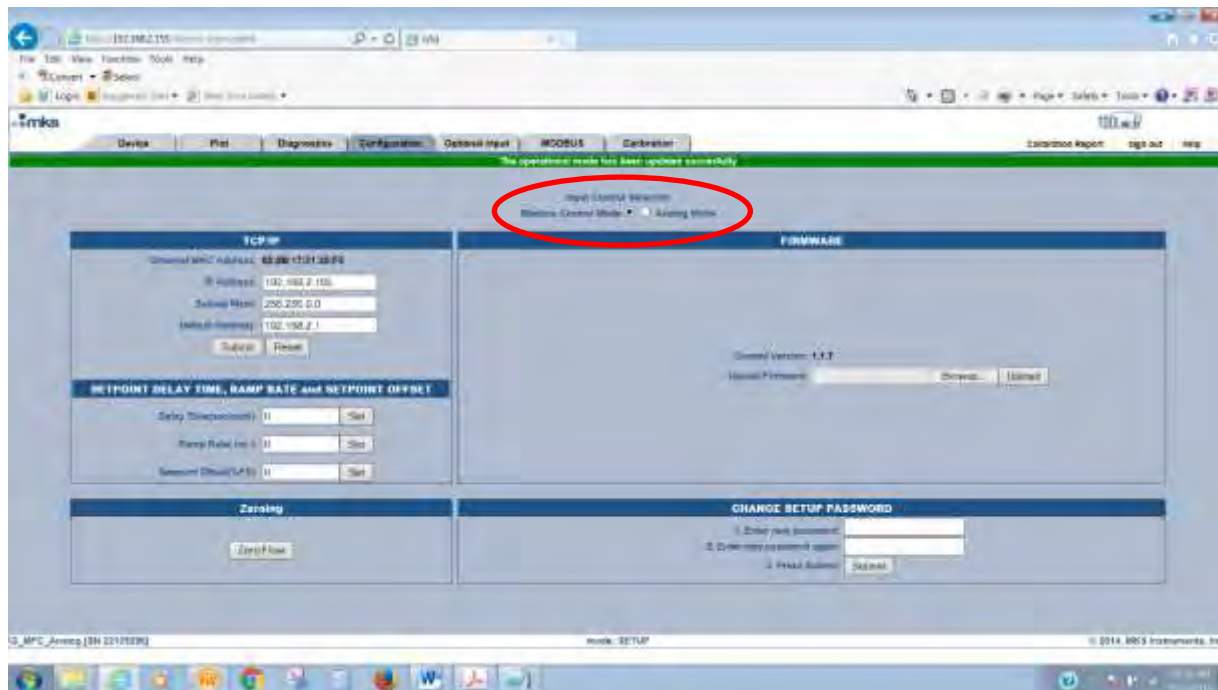

Figure 35: Configuration Page

2. Launch the VI. The VI assumes that the IP address is the default address 192.168.2.155.
3. Select **Initialize**.

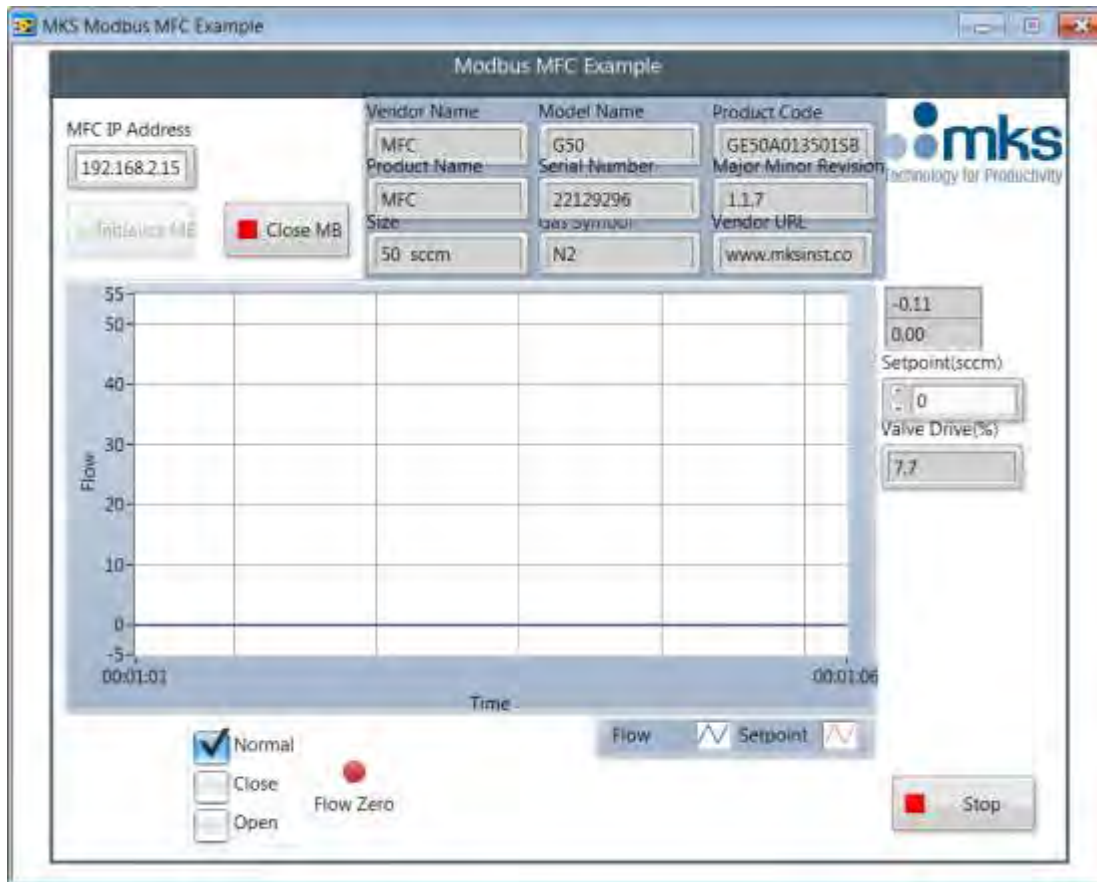

Figure 36: MKS Modbus MFC Example

NOTE

Before leaving the VI, verify the MFC is in Normal Mode as shown above. Enable the Close button before clicking the Stop button and exiting the program.

NOTE

Once Modbus is selected on the Web Browser Configuration page, the MFC will not respond to any primary I/O commands. To return to primary I/O control, the radio button must be returned to its original position using the Web browser.

NOTE

Ethercat MFC does not have the option to be converted to Modbus TCP/IP.

F. Analog Optional Input

Setup Mode: Optional Input Tab

1. Optional input provides the user with the ability to take an external control signal from a pressure transducer and feed that signal back into the MFC through pin 10. Response to a set point then uses that output signal from the transducer to drive the MFC valve, and modulate gas flow such that the pressure in the volume is controlled to the application pressure.
2. Using this mode relegates the MFC to control the pressure output as determined by the set point. Flow under these control conditions is independent of the set point being delivered to the device.
3. This control feature of the MFC is available only with analog 15-pin D devices.
4. The MFC allows the user to select an upstream or downstream pressure control scheme depending on the application.

Basic Wiring Diagram for Optional Input (Downstream Control Example)

Baratron to MFC: Two wires

1. Transducer pressure output Pin 1 ----- MFC Optional Input Pin 10
2. Transducer pressure return Pin 8 ----- MFC Signal Common Pin 11 or 12

Refer to the example on the next page.

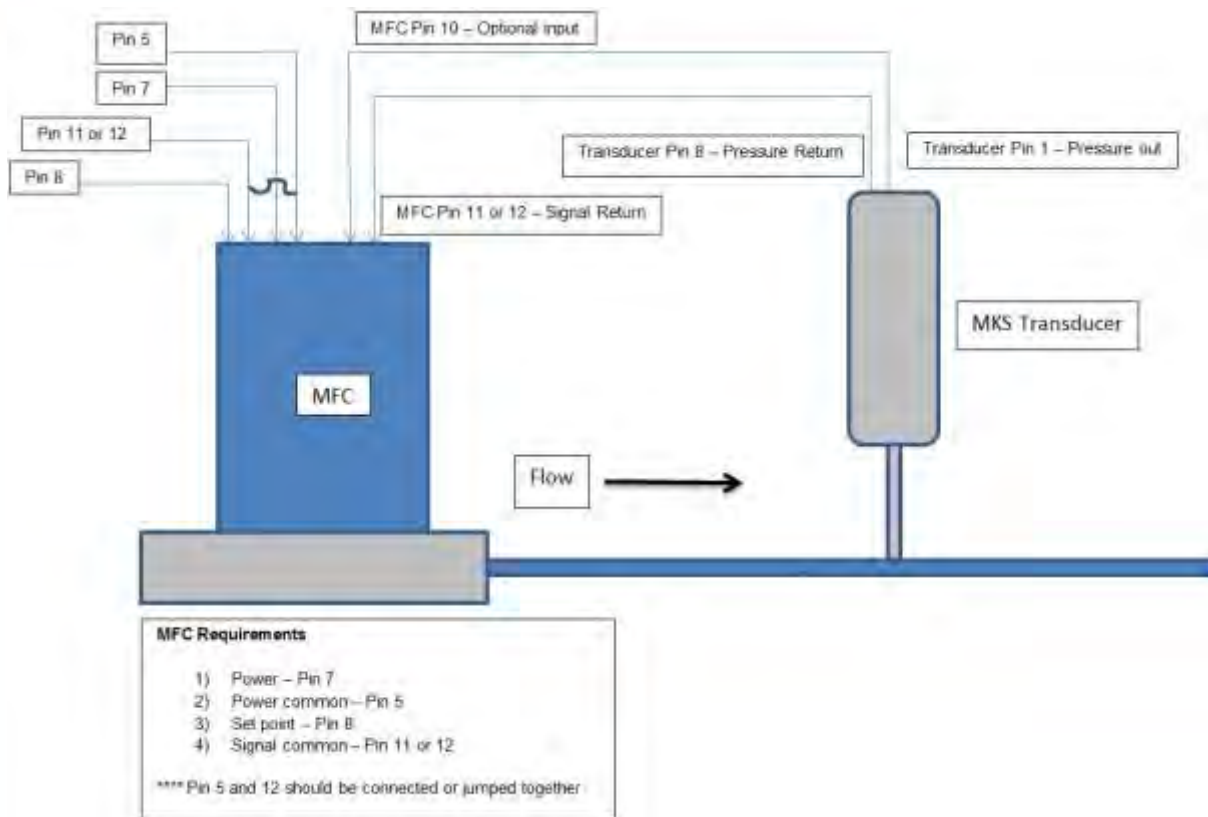

Figure 37: Basic Wiring Diagram for Optional Input (Downstream Control Example)

Optional Input Configuration via the Web Browser

The Web browser is used to enable the Optional Input function.

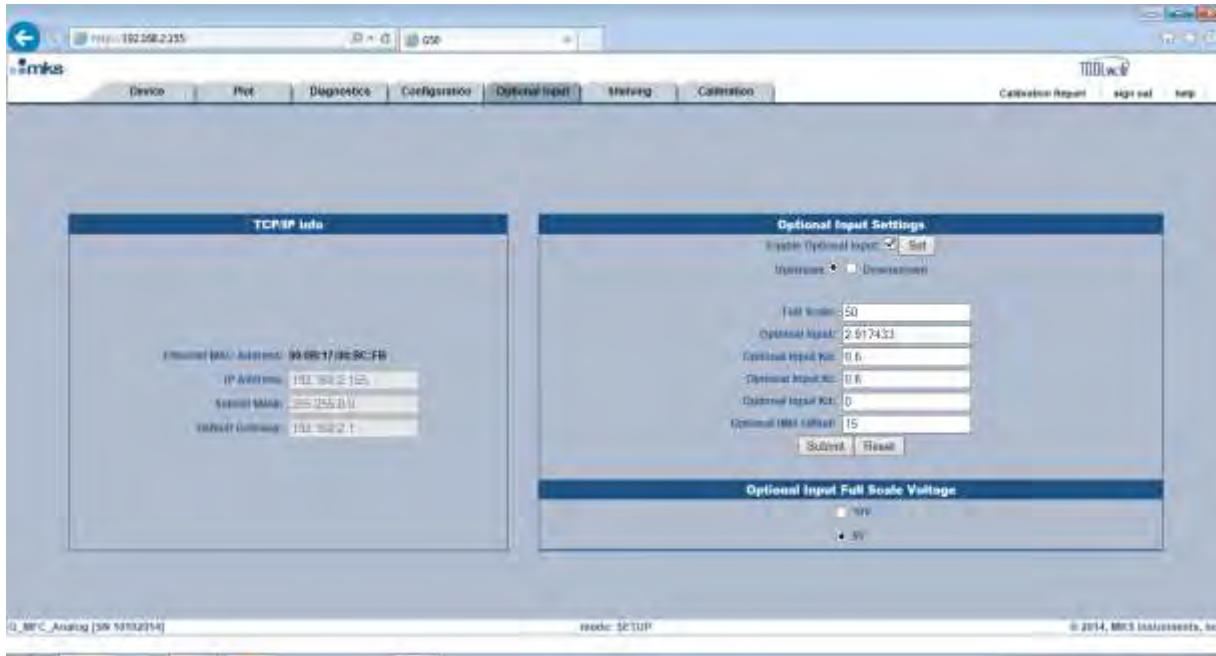

Figure 38: Optional Input Page

Setting up the MFC requires that Optional Input is enabled by checking the enable box and clicking Set.

Optional Input may be set for upstream or downstream control, as determined by the application.

Full scale and full scale voltage of the transducer must be defined.

Response to set point can be adjusted using Optional Input Kp and Ki. These values can also be adjusted on the Plot page as shown below.

To save changes made to define the Optional Input setup, click Submit.

NOTE

The full scale voltage for the transducer has to be determined and selected on the Web page as 5 or 10V full scale. The set point that drives the MFC to respond to the optional input transducer signal also scales according to the full scale voltage selected.

Full scale transducer = 5 V / Set point input 0-5 V

Full scale transducer = 10 V / Set point input 0-10 V

Optional Input Plot Page

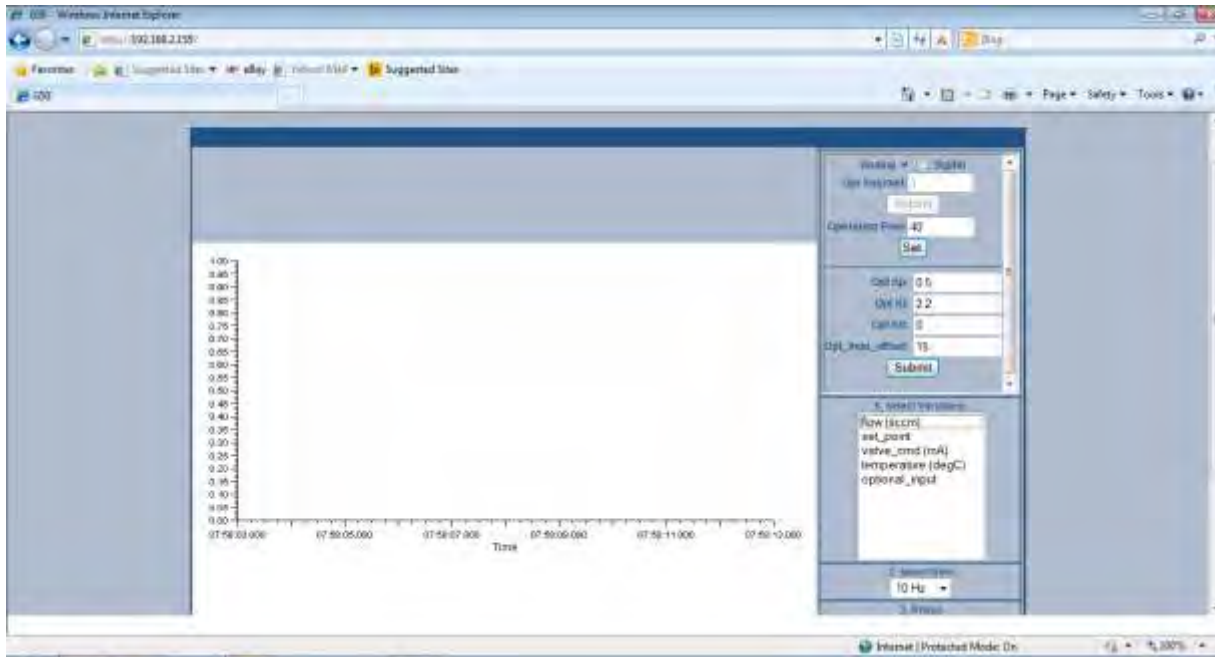

Figure 39: Optional Input Plot Page

The key parameters for tuning an optional input pressure response is Opt_kp and ki.

Opt_min_offset is a factor that is applied to the valve command minimum (valve current starting point) to effectively lower the command min by the value of the offset. For example, an Opt_min_offset of 15, the default, would shift the valve command minimum down by 15 mA.

In some pressure control circumstance normally associated with trying to control to very low at optional input set points (trying to control at very low pressures), the following condition can occur:

MFC command min (valve starting point in flash memory) > valve_cmd at set point
(valve mA at steady state for a given set point)

If this condition is true, the MFC is going to essentially start at a higher current than necessary to actually achieve set point and the response is going to overshoot when the set point is initiated. This parameter can be used to correct overshoot in this very special circumstance.

The default value, 15, should be adequate for the majority of optional input control scenarios and does not need to be changed for the application.

Optional Input Plot Page Example

Pressure control data collected, saved from the Plot page, and transferred into an Excel spreadsheet is presented in the graph below:

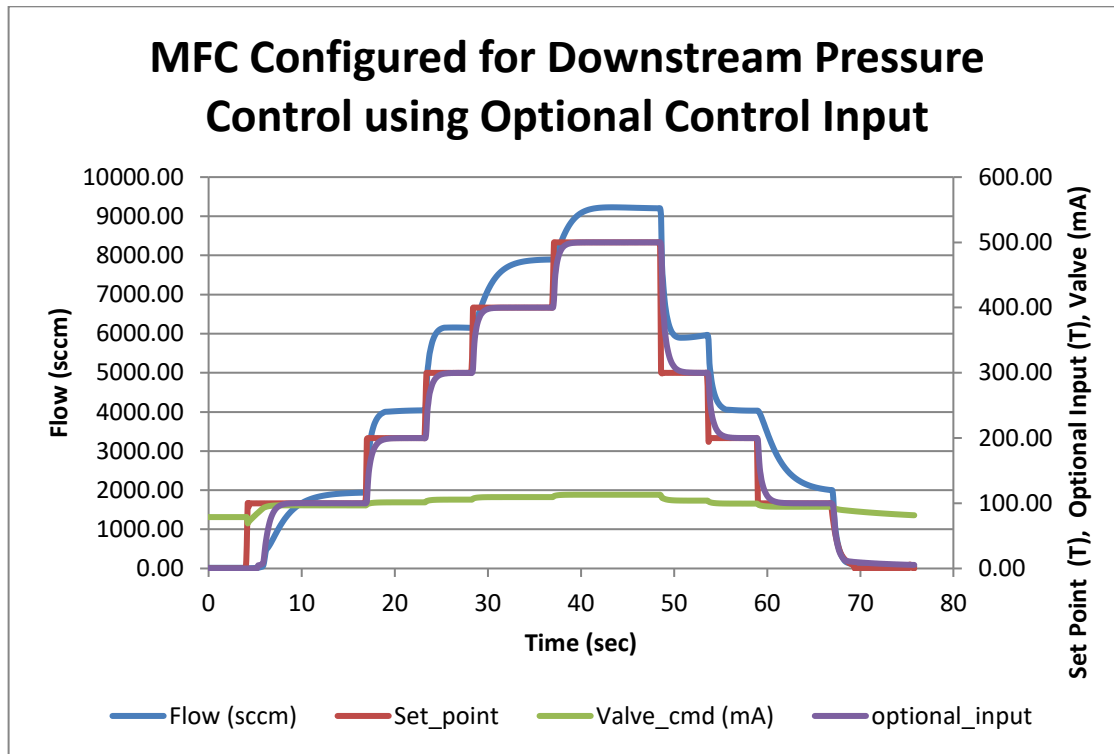

Figure 40: Optional Input Plot Page Example