

ITEM	# of	MNFCTR	P/N	DESCRIPTION
1	1	Pamona	2398	BOX ALUM BLUE 2.250"L X 1.130"W
2	2	Amphenol RF	132121	CONN SMA JACK STR 50 OHM SOLDER
3	5	Stackpole Electronics Inc	CF14JT4K70	RES 4.7K OHM 5% 1/4W AXIAL
4	2	Stackpole Electronics Inc	CF14JT220R	RES 220 OHM 5% 1/4W AXIAL

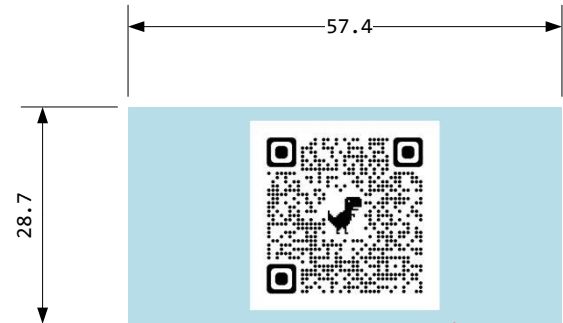

1

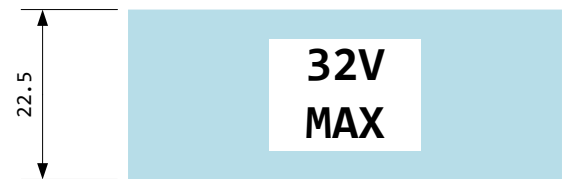

RIGHT

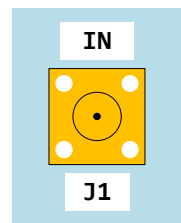

BACK

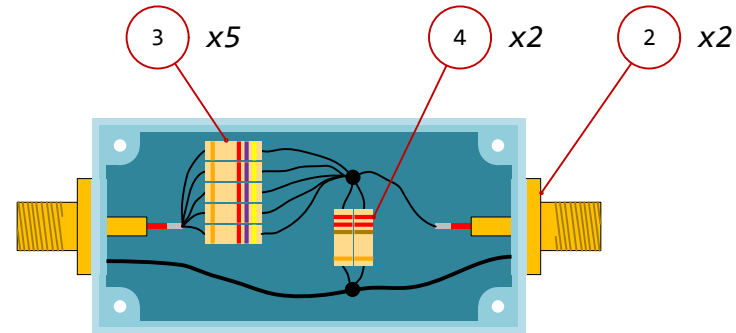

TOP

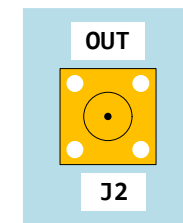

FRONT

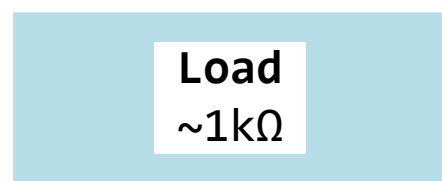

LEFT

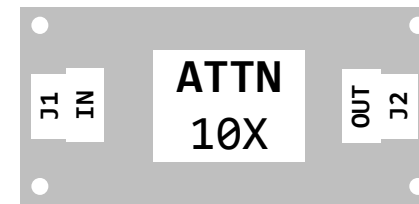

LID: TOP

Scale 1:1

Units: mm

Print Size: B

1 of 1



**ATTN 10x Case
for 1kΩ load**

	DATE	APPROVALS
ENGR Scott T. Block	4/20/2023	_____
DRTS Scott T. Block	4/20/2023	_____
CHKD Scott T. Block	4/25/2023	_____

SA-261-101-35-C00