

**JANOME SCARA/GANTRY ROBOT**  
**JS/JSR4400N/JSG Series**  
**JANOME DESKTOP ROBOT**  
**JR2000N Series**

# **Operation Manual**

## **Features I**

### **(Point Teaching)**

Thank you for purchasing a Janome Robot.

- Read this manual thoroughly in order to ensure proper use of this robot. Be sure to read “For Your Safety” before you use the robot. The information will help you protect yourself and others from possible dangers during operation.
- After having read this manual, keep it in a handy place so that you or the operator can refer to it whenever necessary.
- This manual is written according to IEC 62079.

**JANOME**

# FOR YOUR SAFETY

## Safety Precautions



The precautions in this manual are provided for the customer to make the best use of this product safely, and to provide preventive measures against injury to the customer or damage to property.

**Please follow these instructions**

Various symbols are used in this manual. Please read the following explanations of each symbol.











### ● Symbols Indicating the Degree of Potential Damage or Danger

The following symbols indicate the degree of damage or danger which may be incurred if the safety notes are ignored.

	<b>Warning</b>	The Warning symbol indicates the possibility of death or serious injury.
	<b>Caution</b>	The Caution symbol indicates the possibility of accidental injury or damage to property.

### ● Symbols Indicating the Type of Danger and Preventive Measures

The following symbols indicate the type of safety measures that should be taken.

	Indicates the safety measures that should be taken.
	Be careful. (General caution)
	Indicates a prohibition.
	Never do this. (General prohibition)
	Do not disassemble, modify or repair.
	Do not touch.
	Indicates a necessity.
	Be sure to follow instructions.
	Be sure to unplug power cord from wall outlet.
	Be sure to check grounding.

# FOR YOUR SAFETY

## JR2000N Series

### **Warning**



**Do not use the unit where flammable or corrosive gas is present.**

Leaked gas accumulated around the unit can cause fire or explosion.



**Use the robot in a condensation-free environment between 0 and 40 degrees centigrade with a humidity level of 20 to 95 percent.**

Failure to do so may result in malfunction.

IP Protection Rating: IP30 (IP40 for CE specification models)



**Use the robot in an electric noise-free environment.**

Failure to do so may result in malfunction or breakdown.



**Use the robot in an indoor environment where it is not exposed to direct sunlight.**

Direct sunlight may cause malfunction or breakdown.



**Install the robot in a place which can endure its weight and conditions while running.**

Placing the unit on an insufficient or unstable surface may cause the unit to fall or overturn, thereby causing damage or injury.

Leave a space of at least 30cm between the back of the robot (the side with a cooling fan) and the wall. Insufficient space can lead to overheating or fire.



**Be sure to use within the voltage range indicated on the unit.**

Failure to do so may cause electric shock or fire.



**If your robot has the I/O-S circuit, be sure to install a safeguard such as an area sensor when installing the robot.**

Without a safeguard, going near the robot while it is operating may cause injury.



**Plug the power cord into the wall outlet firmly.**

Failure to do so can cause the plug to heat up and may result in fire.

# FOR YOUR SAFETY

## JR2000N Series

### **Warning**



**Wipe the power plug with a clean, dry cloth periodically to eliminate dust.**  
Dust accumulation can undermine the electrical insulation and cause fire.



**Ensure that the robot is properly grounded before use. Do not use without grounding.**  
Insufficient grounding can cause electric shock and/or fire.



**Be sure to use within the voltage range indicated on the unit.**  
Failure to do so may cause fire or unit malfunction.



**Keep water and oil away from the robot and power cable.**  
Contact with water or oil can cause electric shock, fire, or unit malfunction.  
IP Protection Rating: IP30 (IP40 for CE specification models)



**If tools have been attached (such as the electric screwdriver), make sure they are properly connected.**  
Failure to do so may result in injury or breakdown.



**During prolonged use, be sure to regularly check that the mounting screws are sufficiently tightened.**  
Loose screws may cause injury or breakdown.



**Be sure to check the wiring to the main unit.**  
Improper wiring may result in malfunction or breakdown.



**Be sure to secure the movable parts of the robot before transportation.**  
Failure to do so may result in injury or breakdown.

# FOR YOUR SAFETY

## JR2000N Series

### **Warning**



**Do not bump or jar the unit while it is being transported or installed.**  
Doing so can cause breakdown.



**Be sure to check that no danger is around the operator before starting the robot.**  
Careful attention will protect the operator from injury.



**Do not attempt to disassemble or modify the unit.**  
Disassembly or modification may cause electric shock or malfunction.



**Be sure to unplug the power cord from the wall outlet when examining or lubricating the machine.**  
Failure to do so may cause electric shock or injury.



**If anything unusual (e.g. a burning smell or an abnormal sound) occurs, stop operation and unplug the cable immediately. Contact the dealer from whom you purchased the robot or the office listed on the last page of this manual.**  
Continuous use without repair can cause electric shock, fire, or unit breakdown.



Do not leave the unit plugged in (power cord and connectors) when it is not in use for long periods of time. Accumulated dust can cause fire.  
Be sure to shut off the power supply before removing the power cord.



**Be sure to turn off the robot before inserting and removing all cables.**  
Failure to do so may result in electric shock, fire, data loss or unit malfunction.



**Keep the emergency stop switch within reach of an operator while teaching or running the robot.**  
Failure to do so is dangerous since it may not be possible to stop the robot immediately and safely.

## FOR YOUR SAFETY

### JR2000N Series

## Warning



**Regularly check that the emergency stop switch works properly.**

**For models with I/O-S circuits, also check that they work properly.**

Failure to do so is dangerous since it may not be possible to stop the robot immediately and safely.

# FOR YOUR SAFETY

## JSR4400N Series

### **Warning**



Do not leave the unit plugged in (power cord and connectors) when it is not in use for long periods of time. Accumulated dust can cause fire.  
Be sure to shut off the power supply before removing the power cord.



**Keep the emergency stop switch within reach of an operator while teaching or running the robot.**

Failure to do so is dangerous since it may not be possible to stop the robot immediately and safely.



**Regularly check that the emergency stop switch works properly.**

**For models with I/O-S circuits, also check that they work properly.**

Failure to do so is dangerous since it may not be possible to stop the robot immediately and safely.



**During prolonged use, check the mounting screws etc, regularly and ensure that they are firmly tightened.**

Loose screws may cause injury or breakdown.



**Be sure to use within the voltage range indicated on the unit.**

Failure to do so may cause fire or unit malfunction.



**Keep water and oil away from the robot and power cable.**

Contact with water or oil can cause electric shock, fire, or unit malfunction.

IP Protection Rating: IP20



**Wipe the power plug with a clean, dry cloth periodically to eliminate dust.**

Dust accumulation can undermine the electrical insulation and cause fire.

# FOR YOUR SAFETY

## JSR4400N Series INSTALLATION

### **Warning**



**Always set up a safety barrier.**

Anyone entering the operating range of the robot may be injured.

**Set up an emergency stop interlock system that is triggered when the entrance to the safety barrier is opened.**

**Use the I/O-S connector included in the package.** Ensure there is no other way of entering the restricted area.

Furthermore, **put up a “No Entry” or “No Operating” warning sign in a clearly visible place.**

(An example setup is pictured here.)

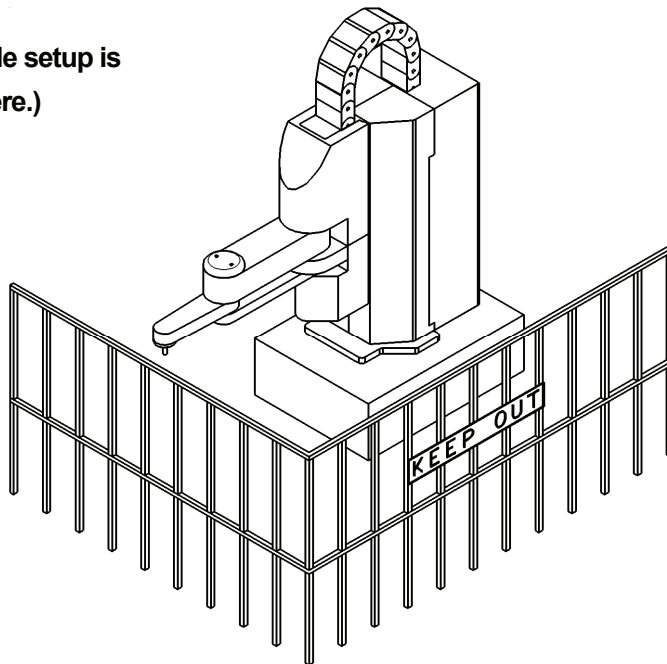

**Make sure the safety barrier is strong enough to protect the operator from flying debris caused during robot operation.**

Always wear protective gear (helmet, protective gloves, protective glasses, and protective footwear) when going inside the safety barrier.



If the object the robot is holding is in danger of flying off or falling, make sure **safety precautions adequate for the object’s size, weight, temperature and chemical composition have been taken.**



# FOR YOUR SAFETY

## JSR4400N Series INSTALLATION

### **Warning**



**Be sure to check grounding before using the unit.**

Improper grounding can cause electric shock, fire, unit malfunction, or breakdown.



**Install the robot in a place which can endure its weight and conditions while running.**

Placing the unit in an insufficient or unstable surface may cause the unit to fall or overturn, and may cause injury or damage.



There is an air intake vent on the lower back of the robot (18mm above the ground). Do not block this vent, or overheating or fire may result.



**Do not use the unit in the presence of flammable or corrosive gas.**

Leaked gas accumulated around the unit can cause fire or explosion.



**For the health and safety of the operator, place the unit in a well-ventilated area.**



**Use the robot in a condensation-free environment between 0 and 40 degrees centigrade with a humidity level of 20 to 90 percent.**

Failure to do so may result in malfunction.  
IP Protection Rating: IP20



**Use the robot in an electric noise-free environment.**

Failure to do so may result in malfunction or breakdown.



**Use the robot in an indoor environment where it is not exposed to direct sunlight.**

Direct sunlight may cause malfunction or breakdown.



**Be sure to use within the voltage range indicated on the unit.**

Failure to do so may cause electric shock or fire.

## FOR YOUR SAFETY

### JSR4400N Series INSTALLATION

## Warning



**Do not attempt to disassemble or modify the unit.**

Disassembly or modification may cause electric shock or malfunction.



**Be sure to secure the movable parts of the robot before transportation.**

Failure to do so may result in injury or breakdown.



**Do not bump or jar the unit while it is being transported or installed.**

Doing so can cause breakdown.



**Be sure to confirm that all the air tubes are connected correctly and firmly.**



**If tools have been attached (such as the electric screwdriver), make sure they are properly connected.**

Failure to do so may result in injury or breakdown.



**Be sure to check the wiring to the main unit.**

Improper wiring may result in malfunction or breakdown.



**Keep the emergency stop switch within reach of an operator while teaching or running the robot.**

Failure to do so is dangerous since it may not be possible to stop the robot immediately and safely.



**Turn off the unit before inserting and removing cables.**

Failure to do so may result in electric shock, fire, or unit malfunction.



**Be sure to turn off the robot before plugging it in.**

## FOR YOUR SAFETY

### JSR4400N Series INSTALLATION

## Warning



**Plug the power cord firmly into the wall outlet.**

Incomplete insertion into the wall outlet causes the plug to heat up and may result in fire. Be sure to turn off the robot before connecting the power cable.



Place the operation box on a flat surface more than 80 cm above the floor so that it is easy to operate.



**Use the unit in an environment that is not dusty or damp.**

Dust or dampness may lead to breakdown or malfunction.

IP Protection Rating: IP20

# FOR YOUR SAFETY

## JSR4400N Series

### DURING OPERATION

# Warning



**When lubricating or inspecting the unit, unplug the power cord from the robot.**

Failure to do so may result in electric shock or injury.

**Be sure to shut off the power supply** before removing the power cord from the robot.



Put up a **“Do Not Operate”** sign on the start switch when people are entering the safety barrier.



**Keep the emergency stop switch within reach of an operator while teaching or running the robot.**

Failure to do so is dangerous since it may not be possible to stop the robot immediately and safely.



Make sure the safety barrier is strong enough to protect the operator from flying debris caused during robot operation.

**Always wear protective gear (helmet, protective gloves, protective glasses, and protective footwear) when going inside the safety barrier.**



**Make sure all the air tubes are connected correctly and firmly.**



**Always be aware of the robot's movement**, even in the Teaching mode.

Careful attention will protect the operator from injury.

## FOR YOUR SAFETY

### JSR4400N Series DURING OPERATION

#### **Warning**



When entering the safety barrier, **do not enter the operating range of the robot.**



If you must go inside the safety barrier, make sure you **push the emergency stop switch** and put a **“Do Not Operate” sign** on the start switch.



When activating the robot, check that **no one is inside the safety barrier and that no object will interfere with the robot’s operation.**



**Under no circumstances should you go inside the safety barrier or place your hands or head inside the safety barrier while the robot is operating.**



**If anything unusual (e.g. a burning smell or an abnormal sound) occurs, stop operation and turn off the robot. Contact the dealer from whom you purchased the robot or the office listed on the last page of this manual.** Continuous use without repair can cause electric shock, fire, or breakdown of the unit.



**Keep the emergency stop switch within reach of an operator while teaching or running the robot.**

Failure to do so is dangerous since it may not be possible to stop the robot immediately and safely.

## FOR YOUR SAFETY

### JS Series and JSG Series

## Warning



**When not in use for extended periods of time, unplug the power cord from the power source.** Accumulated dust leads to fires.

**When unplugging the cord, make sure the power is off.**



**Change the robot battery periodically** (approximately every three years) to prevent unit malfunction or breakdown.



**Keep the emergency stop switch within reach of an operator while teaching or running the robot.**

Failure to do so is dangerous since the robot may not be able to be stopped immediately and safely.



**Regularly check that the I/O-S circuits and emergency stop switch work properly.**

Failure to do so is dangerous since the robot may not be able to be stopped immediately and safely.

## FOR YOUR SAFETY

### JS Series and JSG Series

## **Warning**



**During prolonged use, check the mounting screws etc, regularly and ensure that they are firmly tightened.**

Loose screws may cause injury or breakdown.



**Power the unit only with the rated voltage.**

Excessive voltage can cause fire or unit malfunction.



**Keep water or oil away from the robot, control box and power cable.**

Contact with water or oil can cause electric shock, fire, or unit malfunction.

IP Protection Rating: IP40

## FOR YOUR SAFETY

### JS Series and JSG Series INSTALLATION

## Warning



**Always set up a safety barrier.**

Anyone entering the operating range of the robot may be injured.

**Set up an emergency stop interlock system that is triggered when the entrance to the safety barrier is opened.**

**Use the I/O-S connector included in the package.** Ensure there is no other way of entering the restricted area.

Furthermore, **put up a “No Entry” or “No Operating” warning sign** in a clearly visible place.

(An example setup is  
pictured here.)

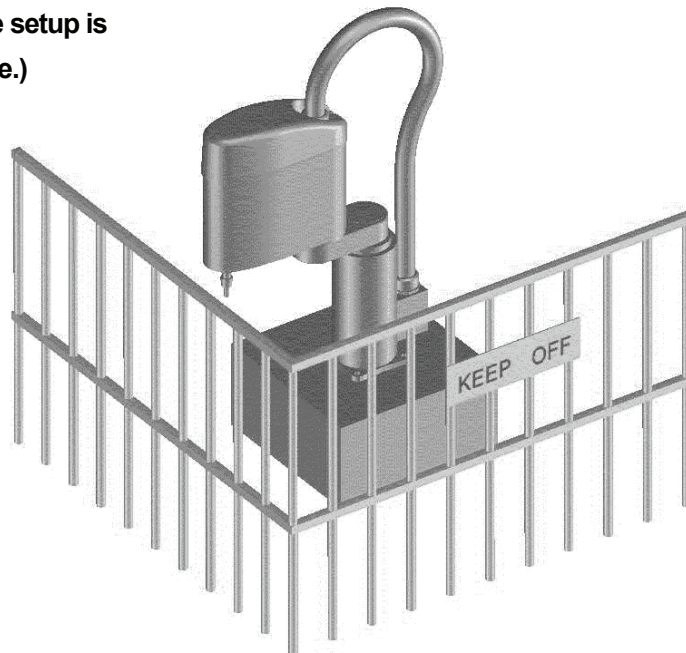

**Make sure the safety barrier is strong enough to protect the operator from flying debris caused during robot operation.**

Always wear protective gear (helmet, protective gloves, protective glasses, and protective footwear) when going inside the safety barrier.



If the object the robot is holding is in danger of flying off or falling, make sure **safety precautions adequate for the object’s size, weight, temperature and chemical composition have been taken.**



# FOR YOUR SAFETY

## JS Series and JSG Series INSTALLATION

### **Warning**



**Be sure to check grounding before you use the unit.**

Improper grounding can cause electric shock, fire, unit malfunction, or breakdown.



**Plug the power cord firmly into the wall outlet and check for dust.**

Incomplete insertion into the wall outlet causes the plug to heat up and may result in fire.

**Be sure to shut off the power supply before connecting the power cable.**



**Install the robot in a place which can endure its weight and conditions while running.**

Placing the unit on an insufficient or unstable surface may cause the unit to fall or overturn, thereby causing damage or injury.

Be sure to leave a space of at least 30cm between the back of the robot (the side with a cooling fan) and the wall. Insufficient space can lead to overheating or fire.



**Do not attempt to disassemble or modify the unit.**

Disassembly or modification may cause electric shock or malfunction.



**Be sure to use within the voltage range indicated on the unit.**

Failure to do so may cause electric shock or fire.



**Do not use the unit where flammable or corrosive gas is present.**

Leaked gas accumulated around the unit can cause fire or explosion.



**For the health and safety of the operator, place the unit in a well-ventilated area.**



**Turn off the unit before inserting and removing cables.**

Failure to do so may result in electric shock, fire, or unit malfunction.

# FOR YOUR SAFETY

## JS Series and JSG Series INSTALLATION

### **Warning**



**Be sure to confirm that all the air tubes are connected correctly and firmly.**



**Use the robot in a condensation-free environment between 0 and 40 degrees centigrade with a humidity level of 20 to 90 percent.**  
Failure to do so may result in malfunction.  
IP Protection Rating: IP40



**Use the robot in an electric noise-free environment.**  
Failure to do so may result in malfunction or breakdown.



**Be sure to secure the movable parts of the robot before transportation.**  
Failure to do so may result in injury or breakdown.



**Do not bump or jar the unit while it is being transported or installed.**  
Doing so can cause breakdown.



**Use the robot in an indoor environment where it is not exposed to direct sunlight.**  
Direct sunlight may cause malfunction or breakdown.



**If tools have been attached (such as the electric screwdriver unit), make sure they are properly connected.**  
Failure to do so may result in injury or breakdown.



**Check the wiring to the main unit.**  
Improper wiring may result in malfunction or breakdown.



**Keep the emergency stop switch within reach of an operator while teaching or running the robot.**  
Failure to do so is dangerous since it may not be possible to stop the robot immediately and safely.

# FOR YOUR SAFETY

## JS Series and JSG Series INSTALLATION

### **Warning**



**Be sure to turn off both the robot and the power source before plugging in the power cable.**



**Be sure to remove the eyebolt after installing the robot.**  
If it is not removed, the Arm may bump into it, thereby causing damage or injury.



Place the control box on a flat surface more than 80 cm above the floor so that it is easy to operate.



**Use the unit in an environment that is not dusty or damp.**  
Dust or dampness may lead to breakdown or malfunction.  
IP Protection Rating: IP40



**Use the Clean Room type model in an environment of Clean Class 10\* or less.**

\*: Federal Standard 209D (FED-STD209D)

# FOR YOUR SAFETY

## JS Series and JSG Series DURING OPERATION

### **Warning**



**When lubricating or inspecting the unit, unplug the power cord from the robot.**

Failure to do so may result in electric shock or injury.

**Be sure to shut off the power supply** before removing the power cord from the robot.



Put a **“Do Not Operate” sign** on the start switch when people are entering the safety barrier.



**Keep the emergency stop switch within reach of an operator while teaching or running the robot.**

Failure to do so is dangerous since it may not be possible to stop the robot immediately and safely.



Make sure the safety barrier is strong enough to protect the operator from flying debris caused during robot operation.

**Always wear protective gear (helmet, protective gloves, protective glasses, and protective footwear) when going inside the safety barrier.**



**Make sure all the air tubes are connected correctly and firmly.**



**Always be aware of the robot's movement**, even in the Teaching mode.

Careful attention will protect the operator from injury.

## FOR YOUR SAFETY

### JS Series and JSG Series DURING OPERATION

#### **Warning**



When entering the safety barrier, **do not enter the operating range of the robot.**



If you must go inside the safety barrier, make sure you **push the emergency stop switch** and **put a “Do Not Operate” sign** on the start switch.



When starting the robot, check that **no one is within the safety barrier and that no object will interfere with the robot’s operation.**



**Under no circumstances should you go inside the safety barrier or place your hands or head inside the safety barrier while the robot is operating.**



**If anything unusual (e.g. a burning smell or an abnormal sound) occurs, stop operation and turn off the robot. Contact the dealer from whom you purchased the robot or the office listed on the last page of this manual.**  
Continuous use without repair can cause electric shock, fire, or breakdown of the unit.



**Keep the emergency stop switch within reach of an operator while teaching or running the robot.**

Failure to do so is dangerous since it may not be possible to stop the robot immediately and safely.

# PREFACE

The Janome Desktop Robot JR2000N Series and pulse motor driven Janome SCARA Robot JSR4400N Series are a new style of low-cost, high-performance robots. We have succeeded in reducing the price while maintaining functionality. Energy- and space-saving qualities have been made possible through the combined use of stepping motors and specialized micro step driving circuits.

The servomotor driven Janome SCARA Robot JS Series and servomotor driven Gantry Robot JSG Series feature diverse applications, high speed, rigidity and precision, and can accommodate a wide variety of requirements.

There are several manuals pertaining to these robots.

Setup	Explains how to set up the robot. <ul style="list-style-type: none"> <li>● <b>Be sure to read this manual before you operate the robot.</b></li> <li>● <b>This manual is designed for people who receive safety and installation instructions regarding the robot.</b></li> </ul>
Maintenance	Explains maintenance procedures for the robot. <ul style="list-style-type: none"> <li>● <b>Be sure to read this manual before you operate the robot.</b></li> <li>● <b>This manual is designed for people who receive safety and installation instructions regarding the robot.</b></li> </ul>
Basic Instructions	Provides part names, data structures, and the basic knowledge necessary to operate the robot.
Quick Start	Explains the actual operation of the robot with simple running samples.
Teaching Pendant Operation	Explains how to operate the robot via the teaching pendant.
PC Operation	Explains how to operate the robot from a computer (using the JR C-Points software).
Features I	Explains point teaching.
Features II	Explains commands, variables, and functions.
Features III	Explains features such as run mode parameters, sequencer programs, and other functions used during operation.
Features IV	Explains features in the Customizing mode.
External Control I (I/O-SYS)	Explains the I/O-SYS control.
External Control II (COM Communication)	Explains the COM communication control system (COM1 – COM3).
Specifications	Outlines general specifications such as the robot's operating range, weight, etc.

**Note:** These products are regularly updated, therefore the product specification outlines in this manual may differ from those of the robot in your possession.

**These manuals are based on the standard specifications. Menu items may vary depending on the model.**

Please be sure to follow the instructions described in these manuals. Proper use of the robot will ensure continued functionality and high performance.



Be sure to turn off the robot and check that the power to the robot is shut off before plugging in the power cord.



**BE SURE TO PROPERLY GROUND THE MACHINE WHEN INSTALLING.**



Be sure to save data whenever it is added or modified.  
**Any unsaved data will be lost when the robot is turned off.**

# CONTENTS

## Features I

FOR YOUR SAFETY	i
PREFACE	xxi
CONTENTS	xxiii
PROGRAM	1
PROGRAM NAME	4
PTP CONDITION NUMBER FOR HOME	5
WORK HOME	6
Point Type	6
Point Job Data and Additional Function Data	6
JOB ON START OF CYCLE	7
CYCLE MODE	8
PTP CONDITION (PROGRAM DATA)	9
JS Series	9
JR2000N Series/JSR4400N Series	13
CP CONDITION (PROGRAM DATA)	15
TOOL DATA	16
MOVE AREA LIMIT	18
ABSOLUTE, RELATIVE & MOVING AMOUNT (POSITION DATA TYPE)	19
PTP DRIVE	21
PTP Point	21
PTP Evasion Point	22
CP DRIVE	23
Linear Movement	23
Arc Movement	23
POINT JOB	24
Point Job	25
Job before Moving	25
Job while Moving	26
Job while CP Moving	26



PTP CONDITION (ADDITIONAL FUNCTION DATA) _____	28
CP CONDITION (ADDITIONAL FUNCTION DATA) _____	29
TOOL DATA _____	30
PALLET ROUTINE _____	32
Pallet Routine Type _____	32
Parameter _____	34
Pallet Routine by Point Job Data Command _____	36
Pallet Routine at PTP Points _____	37
Pallet Routine at CP Start Point _____	38
Circle Pallet _____	39
Pick-and-Place Operation in the Pallet _____	40
How to Terminate the Pallet Routine _____	45
WORKPIECE ADJUSTMENT (NUMERIC ADJUSTMENT) _____	47
EXECUTE CONDITION _____	49
TAG CODE _____	50

# PROGRAM

A program consists of two items: the program data that controls the program and the point data that includes the position coordinates at which the robot performs the operation. (Multiple point data is also referred to as a *point data array*.)

Program				
Program Data	Point Data [01]	Point Data [02]	...	Point Data [28]

## Data

Program data consists of the following ten items:

1. Program Name: You can use up to 40 – 120 characters in combination, depending on the character types, to name the program.
2. PTP Condition Number for Home: Settings when the robot Axis or Arm moves from the last point to the work home position after a cycle of operation.  
(Available for JSR4400N, JS, and JSG Series only)
3. Work Home: This is the point (coordinates) where the robot Axes return to and wait for the next start instructions after running the last point of the program in the [1 Cycle Playback] operation.
4. Job on Start of Cycle: The robot will perform the point job data designated by the set number.  
If [Continuous Playback] is selected, the robot will perform the point job data only when it receives start instructions after completing the [Job on Start of Cycle] set in the [Job and Sequencer on Run Mode] menu.



## **Warning**

Note that the Move commands (e.g. Call Program) included in the set point job data will be ignored.

5. Cycle Mode: This is the operation mode that includes [1 Cycle Playback] and [Continuous Playback].

6. PTP Condition: This includes the settings (e.g. speed) for shifting from one point to another in the PTP drive. (Deactivated in the CP drive)
7. CP Condition: The settings (e.g. speed) for shifting from one point to another in the CP drive. (Deactivated in the PTP drive)
8. Tool Data: Consists of the tool weight and the distance from the standard tool position (R-Axis center) to the tool center point.
9. Move Area Limit: The maximum coordinates and angles which can be set for each robot Axis.
10. Position Data Type: Consists of the following three coordinates:
  - Absolute: The position data value is equal to **the robot's absolute coordinates**.
  - Relative: The position data is equal to **the distance from the program start coordinates to the current position coordinates**.
  - Moving Amount: The position data value is equal to **the distance to the next point**.

Point data consists of the following six items:

1. Coordinates (R, L)X, (R, L)Y, Z, R: The point coordinates (X, Y, Z, R) data  
 If you are using the JS and JSR4400N Series, it includes identification of RX-RY or LX-LY expression (Righty or Lefty)\* and point coordinates (X, Y, Z, R) data for X-Y Cartesian coordinate system. (For J1-J2 Axis coordinate system, it includes J1, J2, J3, and J4 Axes coordinates data.)
 

\*: Righty and Lefty indicate the direction in which the robot Arm turns. For details of the Axis coordinate system, see the operation manuals *Basic Instructions ("COORDINATE SYSTEM")* and *Teaching Pendant Operation*.
2. Point Type: Types of points depending on the shifting and adjustment methods employed
3. Line Speed: The shifting speed to the next point in the CP drive: If the robot Axes are not set to continue shifting in the CP drive, this setting is not necessary.
4. Point Job Number: Number assigned to the point job data: The robot will perform point jobs designated by the point job number. You can select from the following four point jobs according to your preference. Depending on the point type set to the point, selection of these point jobs may not be possible.

- Job before Moving: The robot performs the point job before its Axes start shifting from the previous point to the designated point.
  - Job while Moving: The robot performs the point job while its Axes are shifting from the previous point to the designated point in the PTP drive.
  - Job while CP Moving: The robot repeats the point job while its Axes are shifting from the designated point to the next point in the CP drive.
  - Point Job: The robot performs the point job after its Axes have reached the designated point.
5. Additional Function Number: Number assigned to the additional function data: Additional functions can be assigned to a job point if necessary.
6. Tag Code: Value (tag code) assigned to a point

### **Running Programs**

You can operate the robot in various ways by running programs.

The basic operation is “to shift from Point 1 to the last point in numerical order and to perform point job data set to the point”. (See below)

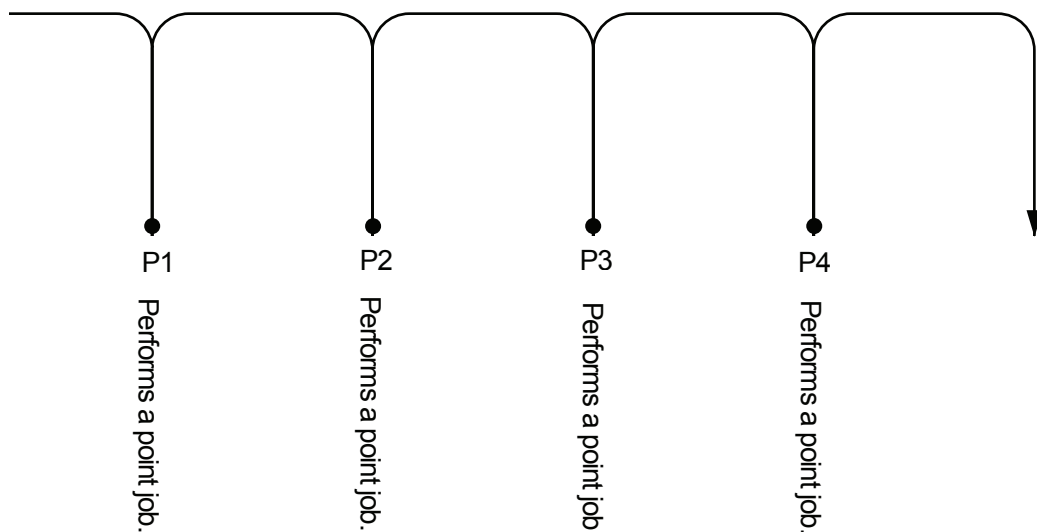

You can operate the robot in various ways by setting point job data (number) or additional function data (number) to point data.

Point job data which is performed at a point is independent from the programs. If you wish to use point job data, select a point job data number and set it to point data. Accordingly, you can use the same point job data at multiple points.

# PROGRAM NAME

---

You can name registered programs to identify the contents. Existing program names can also be modified.

---

**TP**  [Program Data Settings]  
[Program Name]

**PC** [Program] → [Program Data] → [Program Name]

- You can use 40 – 120 characters in combination to name the program. (Up to 120 characters can be entered when using the teaching pendant. When using the PC, the maximum number of characters will be 40 depending on the character type (e.g. Chinese characters).)  
Up to 36 characters\* will be displayed on the registered program list and up to 40 characters\* (the maximum number of characters per line) will be displayed on the screen in the Ext. Run and Switch Run modes. The rest of the characters will be omitted.  
(\*: Characters can be entered using the teaching pendant)

# PTP CONDITION NUMBER FOR HOME

---

- This setting is available for the JSR4400N, JS, and JSG Series only.

You can designate the conditions (e.g. speed) when the robot Axis or Arm moves from the last point to the work home position after a cycle of operation.

If [Cycle Mode] is set to [Continuous Playback], this setting is ignored when the robot Axis or Arm moves from the last point to the first point in a program.

Select an additional function data [PTP Condition] number.

---

**TP**  **MENU** [Program Data Settings]  
[PTP Condition Number for Home]

**PC**  [Program] → [Program Data] → [PTP Condition Number for Home]

If no number is set to [PTP Condition Number for Home], the robot Axis or Arm moves according to additional function data [PTP Condition] settings set to the last point or program data [PTP Condition] settings. (See table below)

Designated Setting	Activated Setting when Returning to the Work Home
[PTP Condition Number for Home] 1 [PTP Condition Setting] 6 for the last point	Additional function data [PTP Condition] 1
[PTP Condition Number for Home] 0 [PTP Condition Setting] 6 for the last point	Additional function data [PTP Condition] 6
[PTP Condition Number for Home] 0 [PTP Condition Setting] 0 for the last point	Program data [PTP Condition]

- **Setting [0] means that no number is designated.**

# WORK HOME

The work home is the point (coordinates) where the robot Axes return to and wait for the next start instructions after running the last point of the program when [Cycle Mode] is set to [1 Cycle Playback]. This point is not necessary when [Cycle Mode] is set to [Continuous Playback]. You can set point job data and additional function data to the work home.

**TP** MENU [Program Data Settings]  
[Work Home]

**PC** [Program] → [Program Data] → [Work Home]

## Point Type

You can set only [PTP Point] or [CP Start Point] to the work home.

Depending on the designated point type, settable point job data or additional function data may vary. (See table below)

## Point Job Data and Additional Function Data

[Point Job] set to the work home is performed **only when the tool center point is on the work home position coordinates after a cycle of operation.**

[Job before Moving] and [Job while Moving] set to the work home is performed when the robot Axis or Arm returns from the last point to the work home after a cycle of operation.

[Job while CP Moving] set to the work home is performed repeatedly while the robot Axis or Arm shifts from the work home position to the next point (Point 1).

(○: Can be set, ×: Cannot be set)

Point Type	Point Job Data/ Additional Function Data	Job before Moving	Job while Moving	Job while CP Moving	Point Job	PTP Condition	CP Condition	Tool Data	Pallet Routine	Execute Condition	Work Adjustment	Tag Code
Work Home ([PTP Point] is set.)		○	○	×	○	○	×	○	○	○	○	○
Work Home ([CP Start Point] is set.)		○	○	○	○	×	○	○	○	○	○	○

# JOB ON START OF CYCLE

If you set a program data [Job on Start of Cycle] number, the set point job data is performed when the operation starts.

Differing from the run mode parameter [Job on Start of Cycle], different types of point job data can be set per program using program data [Job on Start of Cycle].

The jobs are performed in the following order:

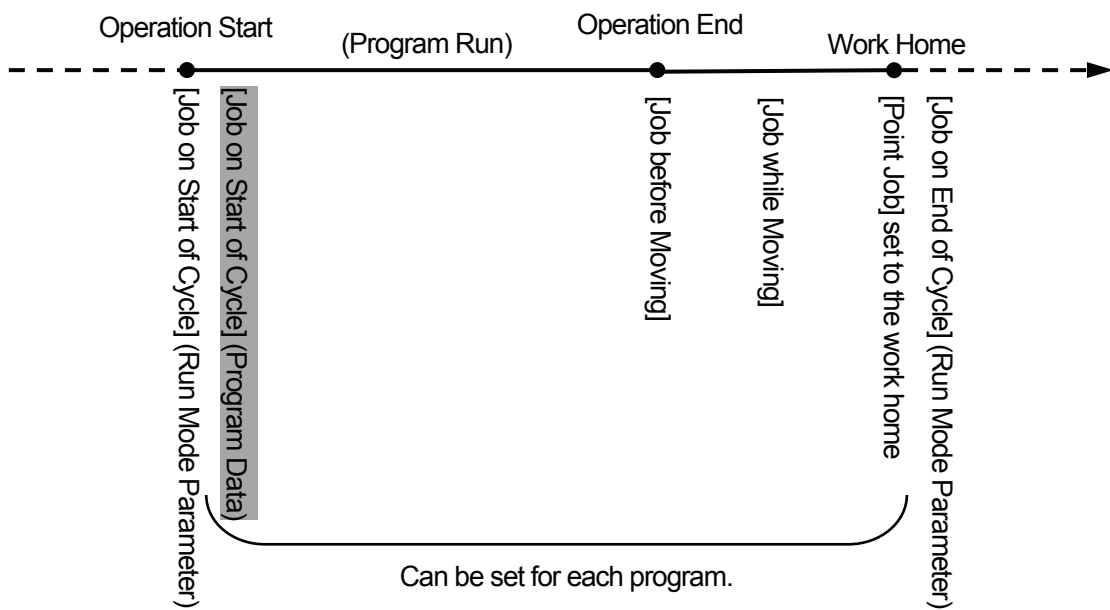

**TP** **MENU** [Program Data Settings]  
[Job on Start of Cycle]

**PC** [Program] → [Program Data] → [Job on Start of Cycle]



# CYCLE MODE

---

There are the following two settings in [Cycle Mode]:

- 1 Cycle Playback: The robot Axis or Arm shifts to the work home and stops operation after running the last point in the selected program.
- Continuous Playback: The robot repeats operation without returning to the work home until it receives the operation end instructions.

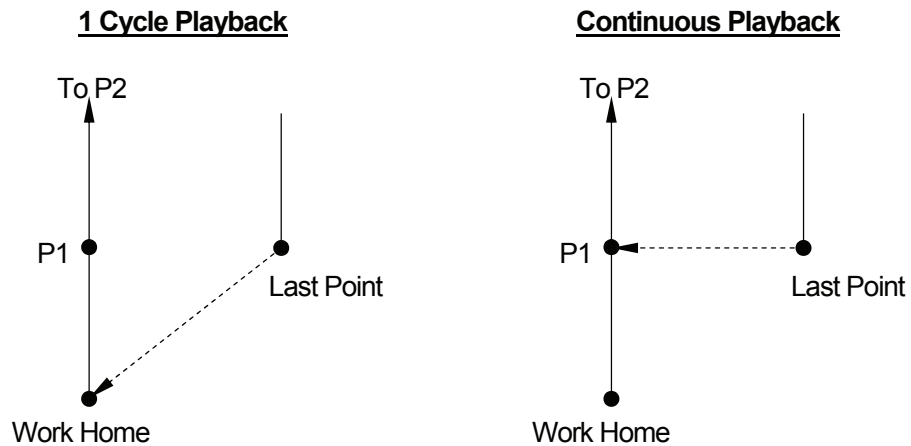

If you select [Continuous Playback], the [Job before Moving], [Job while Moving] and [Point Job] set to the work home are performed only when the robot Axis or Arm returns to the work home by the operation end instructions.

---

**TP** **MENU** [Program Data Settings]  
[Cycle Mode]

**PC** [Program] → [Program Data] → [Cycle Mode]

# PTP CONDITION (PROGRAM DATA)

---

One of the [Program Data Settings] parameters [PTP condition] is the condition settings for all motions between points in a program (in the PTP drive). If you change the program data [PTP Condition], all the speeds and the arch motions in the PTP drive will be changed in that program.

If you wish to change the PTP speed or motion between certain points, register additional function data [PTP Condition] and set it to the desired points.

---

**TP**  MENU [Program Data Settings]  
[PTP Condition]

**PC**  [Program] → [Program Data] → [PTP Condition]

## **JS Series**

The following fourteen PTP conditions are available for the JS Series:

1. J1 Limit Speed
2. J1 Limit Acceleration
3. J2 Limit Speed
4. J2 Limit Acceleration
5. J3 Limit Speed
6. J3 Limit Acceleration
7. J4 Limit Speed
8. J4 Limit Acceleration

Each limit speed or acceleration can be designated as a percentage (%).

## 9. Relative Mode or Absolute Mode

Select the arch motion setting in PTP drive from the following two modes:

- Relative Mode: Z-Axis movement is designated in terms of the distance from a certain point. For example, you can designate the Z-Axis to ascend 10mm from a given point.
  - Absolute Mode: Z-Axis movement is designated in terms of the absolute coordinates. For example, you can designate the Z-Axis to ascend to the coordinate Z=20. The distance from any given point is not considered.
- If you select [Relative Mode], the other Z-Axis movement related items will be [Z Move Height], [Z Up Distance], and [Z Down Distance]. If you select [Absolute Mode], the other Z-Axis movement related items will be [Horizontal Move Pos'n], [Start Horizontal], and [Start Down Pos'n].

## 10. Z Move Height or Horizontal Move Position

- Z Move Height: Vertical distance between the [Horizontal Move Position] and either the start or the end point, depending on which is higher
- Horizontal Move Position: Z-Axis coordinates at which the tool unit shifts horizontally in the PTP drive

## 11. Z Up Distance or Start Horizontal

- Z Up Distance: Ascending distance of the Z-Axis with the X- and Y-Axes constant
- Start Horizontal: Z-Axis coordinate at which the tool unit starts to shift in the X- or Y- direction (horizontally).

## 12. Z Down Distance or Start Down Position

- Z Down Distance: Descending distance of the Z-Axis with the X- and Y-Axes constant
- Start Down Position: Z-Axis coordinate at which the Z-Axis starts to descend after the horizontal shifting

## Arch Motion in the PTP Drive

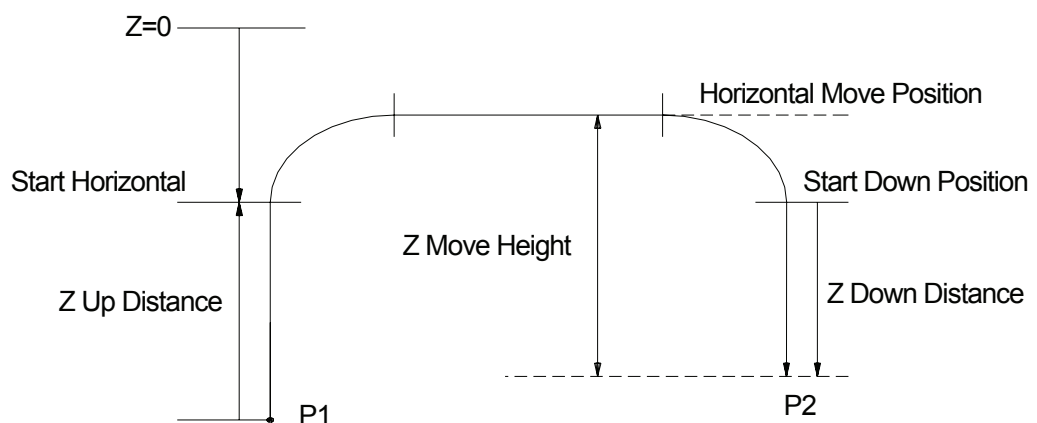

### 13. Finish Mode

You can select how to finish the PTP drive from the following five settings:

- Driver Signal: The robot shifts to the next operation when the [Driver Finish] signal is turned on.
  - Area 3
  - Area 2
  - Area 1
- ) The robot shifts to the next operation when the encoder read position (current motor coordinates) reaches the following ranges relative to the command position (pulse shifting target coordinates).

	JS250				JS350			
	J1 [deg]	J2 [deg]	J3 [mm]	J4 [deg]	J1 [deg]	J2 [deg]	J3 [mm]	J4 [deg]
Area 1			1.25	1.13			1.25	1.25
Area 2			0.313	0.281			0.313	0.313
Area 3			0.078	0.070			0.078	0.078

- Pulse Output: The robot shifts to the next operation after outputting the (move) command pulse to the driver.

#### 14. Acceleration Mode

You can select between [S-Form] and [Constant].

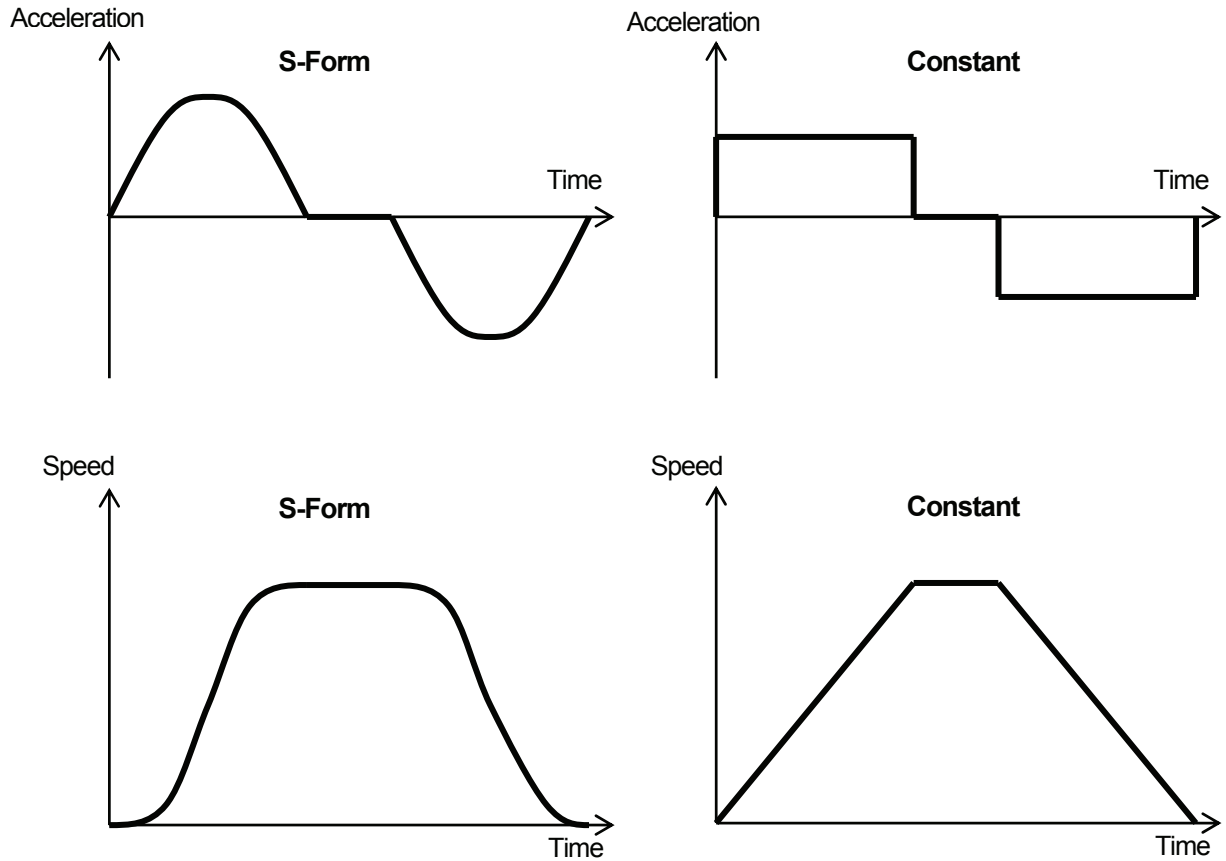

If you switch [Acceleration Mode] without changing the PTP acceleration, the motor will drive so that the finish time will be almost the same as that of the previous mode. The acceleration in [Constant] is represented as [Ac], 157% ( $= \pi/2$ ) lower than the peak acceleration in [S-Form] (represented as [Ap]). You can calculate the acceleration [A] (t) and the velocity [V] (t) when accelerating as follows. The acceleration time is represented as [Tu] and the terminal velocity is represented as [Vm].

$$A(t) = A_c \quad \dots\dots \text{Constant}$$

$$A(t) = A_p * \sin(\omega t) \quad \dots\dots \text{S-Form}$$

$$\omega = \pi / T_u$$

$$A_p = (\pi/2) * A_c$$

$$V(t) = A_c * t = V_m * (t/T_u) \quad \dots\dots \text{Constant}$$

$$V(t) = (V_m/2) * \{1 - \cos(\omega t)\} \quad \dots\dots \text{S-Form}$$

The initial velocity is set to  $V_0 = 0$  in the above formula; however, the actual initial velocity is not strictly equal to 0.

## **JR2000N Series/JSR4400N Series**

The following seven PTP conditions are available for the JR2000N Series and JSR4400N Series:  
These settings are activated only when shifting in the PTP drive.

### 1. PTP Speed

The speed limit in the PTP drive that can be designated in the percentage terms of the maximum speed (1 – 100%)

**The maximum speed for the JR2200N Series is 700mm/s (when neither tool nor workpiece is connected), and for the JR2300N and JR2400N Series is 800mm/s (for both X- and Y-Axes).**

The maximum PTP speed may vary depending on the connected tool or workpiece weight and the distance between points.

Note that the program data [PTP Speed] is the speed limit setting during operation, not the shifting speed setting in the PTP drive.

### 2. R-Axis Rotate Speed (only available for 4-Axis specifications)

The speed limit for the R-Axis in the PTP drive that can be designated in the percentage terms of the maximum speed (1 – 100%)

**The maximum speed is 800deg/s (when no tool is connected).**

If the set [R-Axis Rotate Speed] is too high, it will be reduced automatically so that the R-Axis can rotate completely before reaching the next point.

### 3. R-Axis Acceleration (only available for 4-Axis specifications)

The R-Axis acceleration or deceleration speed limit to rotate or stop in the PTP drive. It can be designated in terms of percentage of the maximum acceleration (1 – 100%)

### 4. Relative Mode/Absolute Mode

Select the arch motion setting in the PTP drive from the following two modes:

- Relative Mode: Z-Axis movement is designated in terms of the distance from a certain point. For example, you can designate the Z-Axis to ascend 10mm from a given point.
- Absolute Mode: Z-Axis movement is designated in terms of the absolute coordinates. For example, you can designate the Z-Axis to ascend to the coordinate Z=20. The distance from any given point is not considered.
- If you select [Relative Mode], the other Z-Axis movement related items will be [Z Move Height], [Z Up Distance], and [Z Down Distance]. If you select [Absolute Mode], the other Z-Axis movement related items will be [Horizontal Move Pos'n], [Start Horizontal], and [Start Down Pos'n].

5. Z Move Height or Horizontal Move Position
  - Z Move Height: Vertical distance between the [Horizontal Move Position] and either the start or the end point, depending on which is higher
  - Horizontal Move Position: Z-Axis coordinates at which the tool unit shifts horizontally in the PTP drive
  
6. Z Up Distance or Start Horizontal
  - Z Up Distance: Ascending distance of the Z-Axis with the X- and Y-Axes constant
  - Start Horizontal: Z-Axis coordinate at which the tool unit starts to shift in the X- or Y- direction (horizontally).
  
7. Z Down Distance or Start Down Position
  - Z Down Distance: Descending distance of the Z-Axis with the X- and Y-Axes constant
  - Start Down Position: Z-Axis coordinate at which the Z-Axis starts to descend after shifting horizontally

### Arch Motion in the PTP Drive

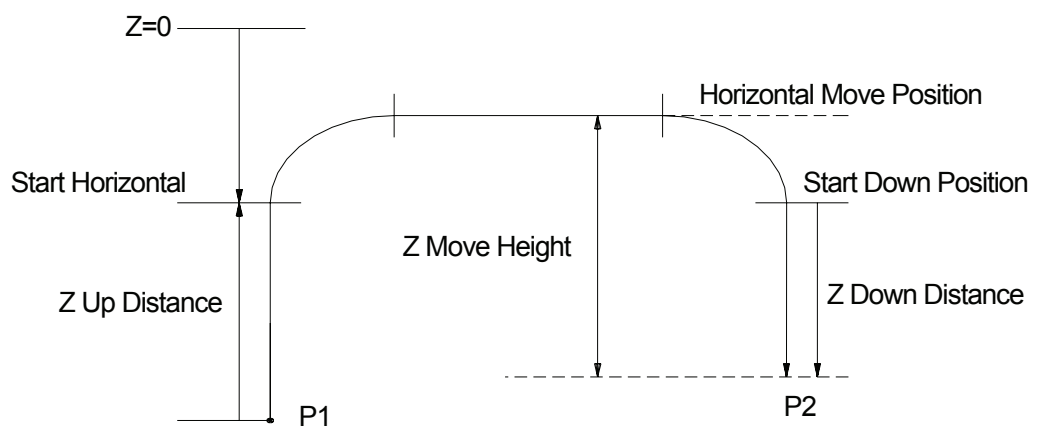

# CP CONDITION (PROGRAM DATA)

---

One of the [Program Data Settings] parameters [CP condition] is the condition settings for all motions between points in a program (in the CP drive). If you change the program data [CP Condition], all the speed and acceleration settings in the CP drive will be changed in that program.

If you wish to change the PTP speed or acceleration between certain points, register the additional function data [CP Condition] and set it to the desired points.

There are the following three settings in [CP Condition].

- CP Acceleration: Acceleration when shifting in the CP drive that can be designated in terms of the maximum acceleration (1 – 100%)
- R-Axis Rotate Speed: R-Axis rotation speed in the CP drive that can be designated in terms of the maximum speed (1 – 100%)  
**The maximum speed is 800deg/s (when no tool is connected).**  
If the set [R-Axis Rotate Speed] is too high, it will be reduced automatically so that the R-Axis can rotate completely before reaching the next point.
- R-Axis Acceleration: R-Axis acceleration in the CP drive that can be designated in terms of the maximum acceleration (1 – 100%)

[CP Speed] (Shifting speed in the CP drive) is not included in [CP Condition]. Set the CP speed directly to each CP point.

---

**TP** MENU [Program Data settings]  
[CP Condition]

**PC** [Program] → [Program Data] → [CP Condition]



# TOOL DATA

There are the following four settings in [Tool Data]:

- Tool Weight
- TCP-X: X-direction distance from the standard tool position (R-Axis center) to the tool center point
- TCP-Y: Y-direction distance from the standard tool position (R-Axis center) to the tool center point
- TCP-deltaZ: Z-direction distance from the registered tool center point to the current tool center point

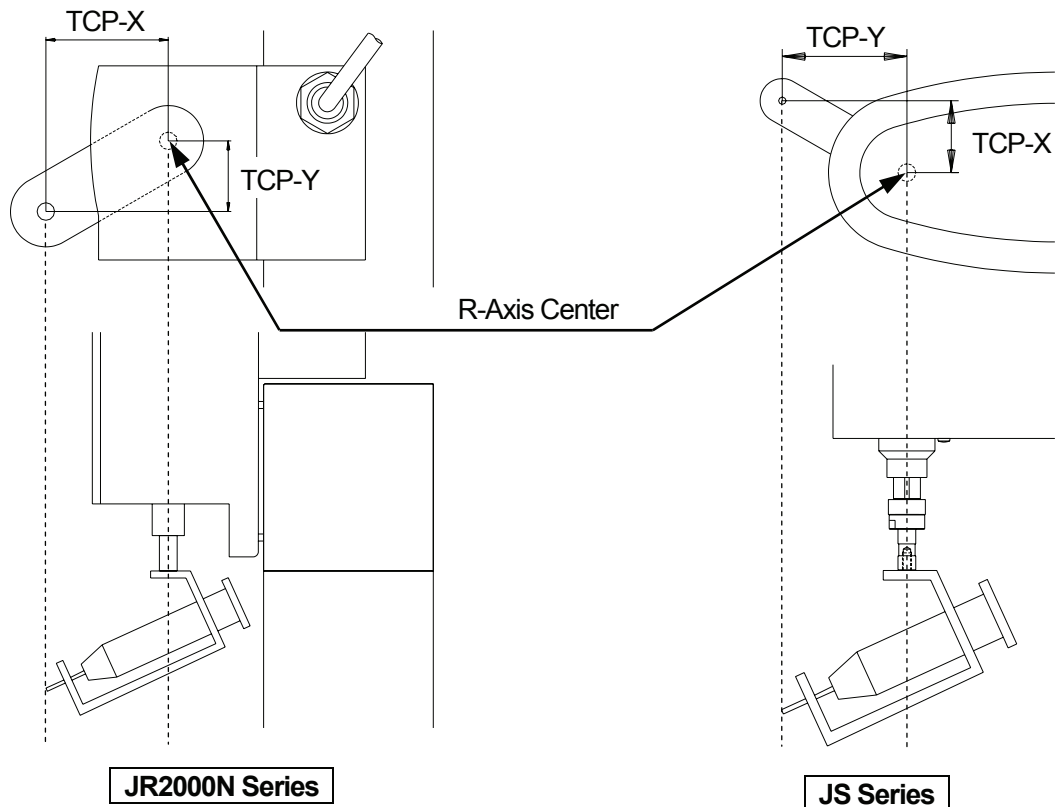

- In a pick-and-place operation, [Tool Weight] is the total of the weight of the tool and the object which the tool is holding.
- If the current tool center point position is different from the registered tool center point position (after changing the tool, for example), add the Z-direction position difference to [TCP-deltaZ].

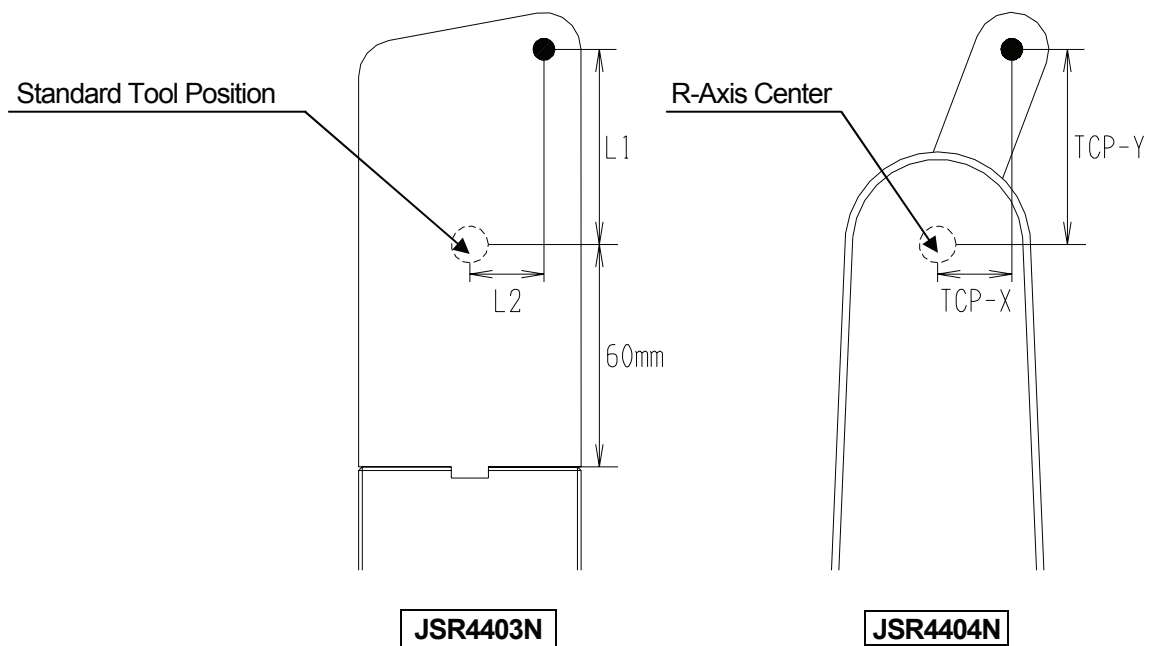

- [TCP-X] is represented as [L2] and [TCP-Y] is represented as [L1] for the JSR4403N (3-Axis model of the JSR4400N Series).

If you select [Direct TCP-XY Setting], you can calculate the values of [TCP-X] and [TCP-Y] by pointing at the same point twice (from different R-Axis angles) using the tool center point.  
 For the JSR4403N, if you select [Direct TCP-XY Setting], you can calculate the values of [L2] and [L1] by pointing at the same point twice (Righty and Lefty)\* using the tool center point.

If you select [Copying to All Programs], you can copy registered tool data to the default program data and the program data in all programs.

You can change the tool data only between certain points by changing additional function data [Tool Data].

\*: Righty and Lefty indicate the directions in which the robot Arm turns. For details of the Axis coordinate system, see the operation manuals *Basic Instructions ("COORDINATE SYSTEM")* and *Teaching Pendant Operation*.

**TP** MENU [Program Data Settings]  
 [Tool Data]

**PC** [Program] → [Program Data] → [Tool Data]

# MOVE AREA LIMIT

---

You can limit the range of the robot Axis or Arm movement. This limit (coordinates) is referred to as [Move Area Limit]. You can set the move area limit for each program.

If any Axis or Arm exceeds the move area limit during operation, an error ([Position is out of range]) will be returned and the robot will stop.

Even in the Teaching Mode, you cannot move the robot Axis or Arm outside the [Move Area Limit] in the selected program using the JOG keys (JOG mode).

- Note that you can move the robot Axis or Arm outside the [Move Area Limit] using the numeric keys (MDI mode and DIRECT mode).  
In these modes, select [Checking Data] from the [Test] menu (press the **MONITOR** key to display the menu) to check if there are any coordinates outside the move area limit.

The following items are included in [Move Area Limit]:

JS Series and JSR4400N Series	JSG Series and JR2000N Series
J1 Upper Limit (+J1 Axis direction rotation is limited.)	X Upper Limit
J1 Lower Limit (-J1 Axis direction rotation is limited.)	Y Upper Limit
J2 Upper Limit (+J2 Axis direction rotation is limited.)	Z Upper Limit
J2 Lower Limit (-J2 Axis direction rotation is limited.)	R Upper Limit
J3 Upper Limit (+J3 Axis direction rotation is limited.)	R Lower Limit
J4 Upper Limit (+J4 Axis direction rotation is limited.)	
J4 Lower Limit (-J4 Axis direction rotation is limited.)	

- You cannot change the X, Y, and Z lower limits for the JS Series and JR Series.
- For the JSR4400N Series, if the angle made by the J1 and J2 Arms exceeds  $\pm 150$  degrees, it is recognized as an error ([Position is out of range]) even when the J1 and J2 Axes are inside the move area limit.
- For the JS Series and JSR4400N Series, an error ([Position is out of range]) may be returned if the angle made by the J1 and J2 Axes is the same as the move area limit.

Use [Copying to All Programs] to copy the registered move area limits to the default program data and the program data in all programs.

---

**TP** **MENU** [Program Data Settings]  
[Move Area Limit]

**PC** [Program] → [Program Data] → [Move Area Limit]

# ABSOLUTE, RELATIVE & MOVING AMOUNT (POSITION DATA TYPE)

---

You can select the coordinate setting (position data) included in point data from [Absolute], [Relative], and [Moving Amount]. The default is set to [Absolute].

- Absolute: Position data value indicates the fixed robot coordinates.
- Relative: Position data value indicates the distance from the coordinate where a program starts. (If the start position coordinate is (0,0), the result will be the same as when [Absolute] is selected.)
- Moving Amount: Position data value indicates the distance to the next point.

Depending on the position data settings, the next point coordinates vary if the position data values are the same. (See below)

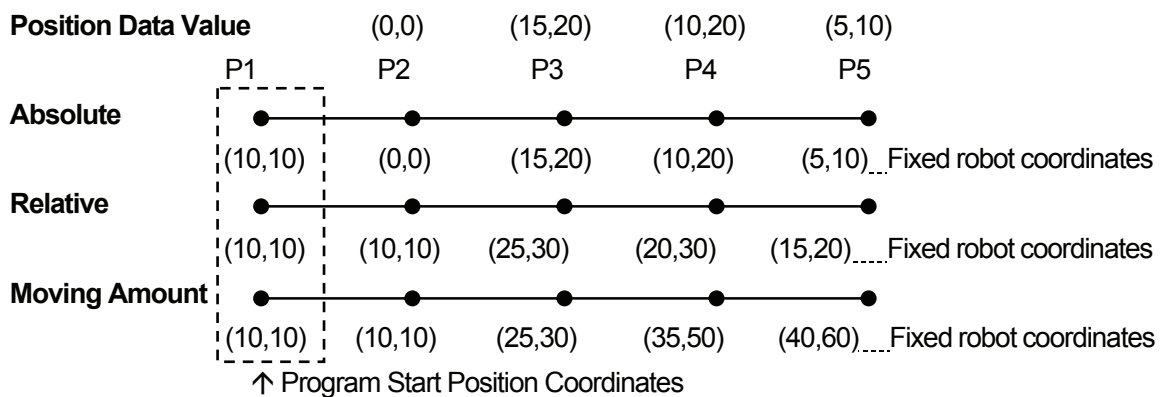

- If you run a program as a subprogram, the robot Axis or Arm will not return to the work home. Also if [Relative] or [Moving Amount] is set in a program, the robot Axis or Arm will not return to the work home.

The robot Axis or Arm returns to the work home only when [Absolute] is set in the program and is performed independently, not by a *callProgram* command.

---

**TP** MENU [Program Data Settings]  
[Position Data Type]

**PC** [Program] → [Program Data] → [Position Data]

- You can set [Position Data Type] as the default program data under the [Program Data Default Setting] menu.
- You can convert the program created under the [Absolute] setting into [Relative] (convert the coordinate values from Point 1 to the last point into the relative coordinate values).

**TP**  EDIT [Transform into Relative]

**PC**  [EDIT] → [Transform into Relative]

### **How to Register a [Relative] Program**

When registering any point in the JOG mode, the position data setting must be set to [Absolute].

When creating a program which is set to [Relative], shift (offset) all the points so as to match the coordinates of the first point to the position (0,0,0) after registering the desired point.

### **How to Register a [Moving Amount] Program**

You cannot convert the registered coordinates into [Moving Amount]. Register any points under the [Moving Amount] setting in the MDI mode.

# PTP DRIVE

“PTP” stands for “Point to Point”. The robot Axis or Arm ascends vertically, shifts in the X or Y direction, and descends vertically to the next point.

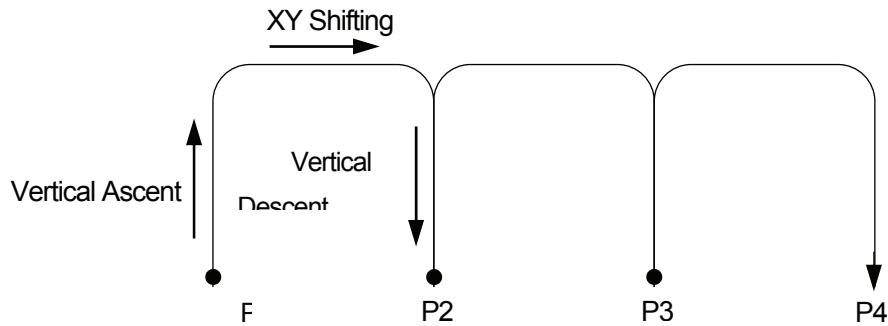

During operation, each robot Axis or Arm shifts in either the PTP drive or the CP drive, depending on the point type setting in point data. It shifts to the next point in the PTP drive if the point type is [PTP Point] or [CP End Point].

## **PTP Point**

If this point type is set to a point, the robot Axis or Arm starts shifting to the next point in the PTP drive. Set the necessary settings, such as the PTP speed or the maximum height of the arch motion, under [PTP Condition] in [Program Data Settings] menu. Any changes in program data [PTP Condition] will affect all the PTP points in a program, excluding points which additional function data [PTP Condition] is set to.

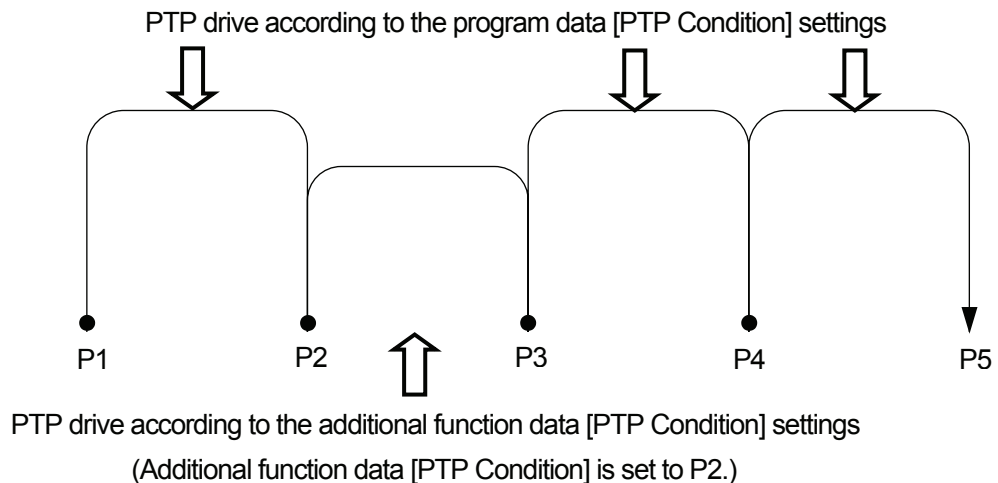

## **PTP Evasion Point**

Register the point type [PTP Evasion Point] to evade any obstacles while shifting to the next point.

- To shift upward (skip over an obstacle), you can register additional function data [PTP Condition] instead.

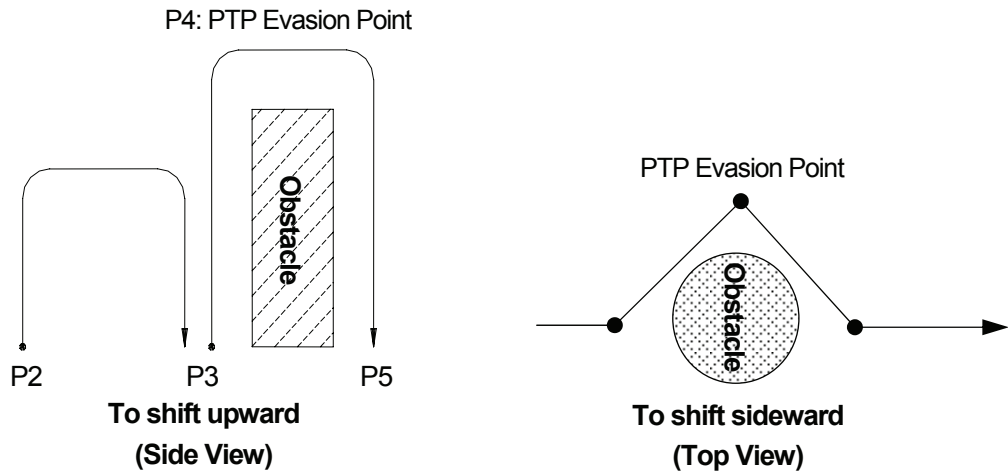

You can set several PTP evasion points continuously.

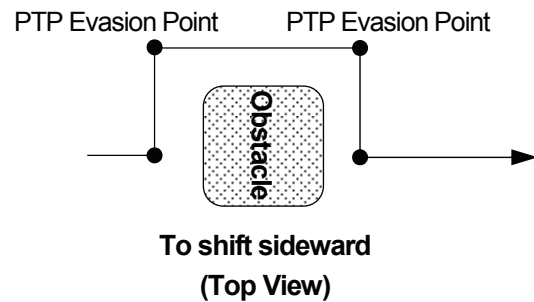

You cannot set any point job data or additional function data, except [Execute Condition], to the PTP evasion point.

# CP DRIVE

“CP” stands for “Continuous Path”. In the CP drive, each robot Axis or Arm shifts in a straight line or in an arc to the designated point at a constant speed. Select the CP drive if you wish to move the robot Axis or Arm in an arch motion.

During operation, each robot Axis or Arm shifts either in the PTP drive or the CP drive, depending on the point type setting in point data. It shifts from the [CP Start Point] point to the [CP End Point] point in the CP drive. (It then shifts in the PTP drive from the [CP End Point] point to the next point.)

- For the JSR4400N, JS, and JSG Series, you cannot change the Arm type (Lefty or Righty) during the CP drive.

## Linear Movement

You can bend a straight line as illustrated below if you register either [CP Passing Point] or [CP Stop Point] between [CP Start Point] and [CP End Point].

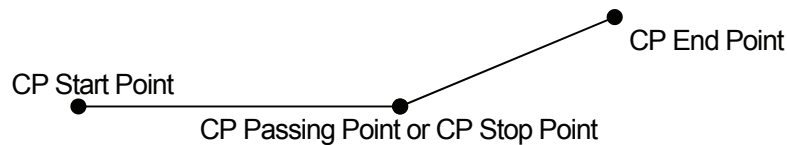

You need to set the [CP Speed] to points which [CP Start Point], [CP Passing Point], [CP Stop Point], and [CP Arc Point] are set to.

## Arc Movement

In the CP drive, you can move the robot Axis or Arm in an arc.

Set [CP Start Point], [CP Arc Point], and [CP End Point] to consecutive points.

The robot Axis or Arm shifts on the arc created by the three points.

If you wish to continue the CP drive and to draw an arc, set [CP Passing Point] or [CP Stop Point] to the point instead of [CP End Point].

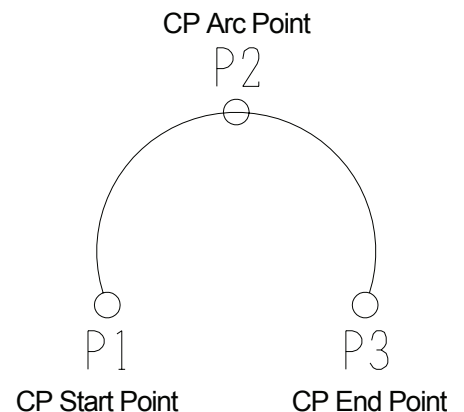
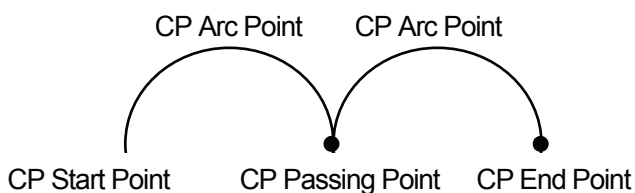



# POINT JOB

Point job data is a set of commands and logic operations that is performed at job points.

The robot will perform point jobs selected from the point job number list on the point settings screen. (See the chapter “POINT JOB DATA” of the *Teaching Pendant Operation* manual for details)

You can set up to four point jobs, [Job before Moving], [Job while Moving], [Point job], and [Job while CP Moving], which are performed separately, to one point. However, depending on the point type set to the point, selection may not be possible. (See the table below)

(○: can be set, ×: cannot be set)

Point Type	PTP Point	CP Start Point	CP Passing Point	CP Stop Point	CP Arc Point	CP End Point	PTP Evasion Point	Work Home (PTP Point)	Work Home (CP Start Point)
Job before Moving	○	○	×	×	×	×	×	○	○
Job while Moving	○	○	×	×	×	×	×	○	○
Point Job	○	○	○	○	○	○	×	○	○
Job while CP Moving	×	○	×	○	×	×	×	×	○

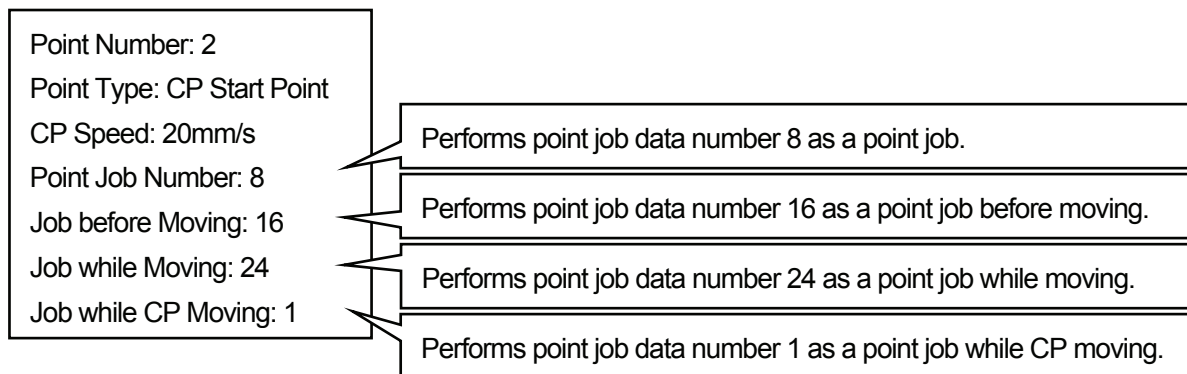

**TP** MENU [Point Job Settings]

**PC** [Data] → [Point Job]

Create the point job data and set the point job number to the desired point.

## **Point Job**

If you set the point job data [Point Job] to a point, the point job is performed after the robot Axis or Arm reaches the point. After performing the “point job”, the robot Axis or Arm shifts to the next point.

If [Point Job] is set to the work home, the point job is performed only when the tool center point is on the work home position coordinates after a cycle of operation.

### **Example: [Point Job] Is Set to the CP Start Point.**

● indicates the point where the [Point Job] is set.

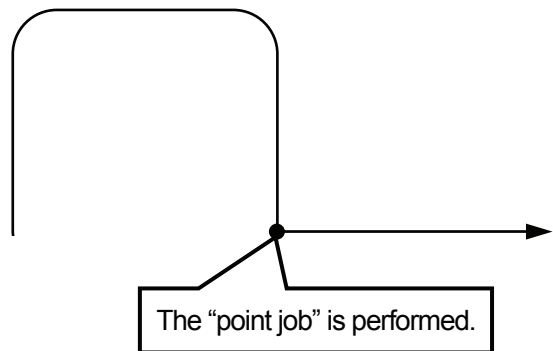

## **Job before Moving**

If you set the point job data [Job before Moving] to a point, the point job is performed before shifting to the point. After performing the point job at the previous point, the robot Axis or Arm performs the “job before moving”, and then shifts to the point where [Job before Moving] is set. If [PTP Evasion Point] is set to the previous point, the robot Axis or Arm performs the “job before moving” before shifting to the [PTP Evasion Point] point.

If you set [Job before Moving] to the work home, the point job is performed before the robot Axis or Arm returns to the work home from the last point after a cycle of operation.

### **Example: [Job before Moving] Is Set to the CP Start Point.**

● indicates the point where the [Point Job] and [Job before Moving] are set.

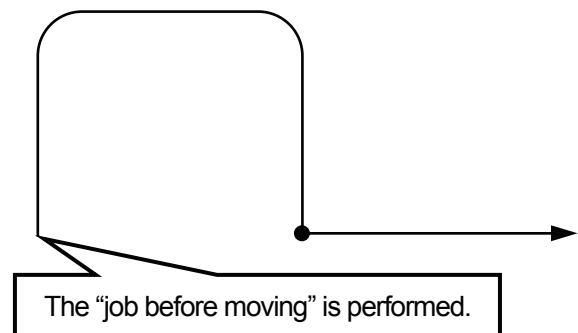

### **Job while Moving**

If you set the point job data [Job while Moving] to a point, **the robot Axis or Arm repeats the point job** after it starts to shift from the previous point to the point where the [Job while Moving] is set. When the robot Axis or Arm reaches the point, it terminates the point job even while performing it. If the [PTP Evasion Point] is set to the previous point, the robot Axis or Arm repeats the point job after it starts to shift from the previous point of the [PTP Evasion Point] to the point where the [Job while Moving] is set. If the [Job while Moving] is set to the work home, the point job is performed before the robot Axis or Arm returns to the work home from the last point after a cycle of operation.

Do not use [Job while Moving] in combination with move commands, such as *goPoint* and *lineMove*, since it is performed while driving.

#### **Example: [Job while Moving] Is Set to the CP Start Point.**

● indicates the point where [Point Job], [Job before Moving], and [Job while Moving] are set.

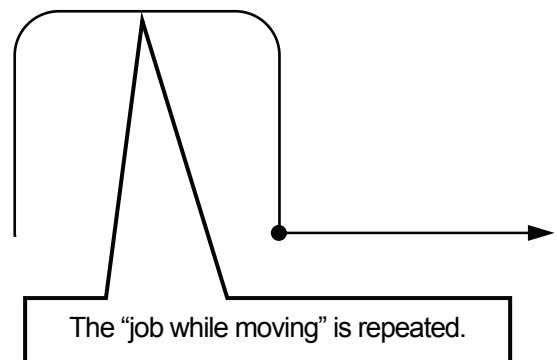

### **Job while CP Moving**

If you set point job data [Job while CP Moving] to a point, the robot Axis or Arm repeats the point job while it shifts from that point to the next point ([CP End Point] or [CP Passing Point]) in the CP drive. When the robot Axis or Arm reaches the next point, it terminates the point job even while performing a job.

Do not use [Job while Moving] in combination with move commands, such as *goPoint* and *lineMove*, since it is performed while driving.

#### **Example: [Job while CP Moving] Is Set to the CP Start Point.**

● indicates the point where [Point Job], [Job before Moving], [Job while Moving], and [Job while CP Moving] are set.

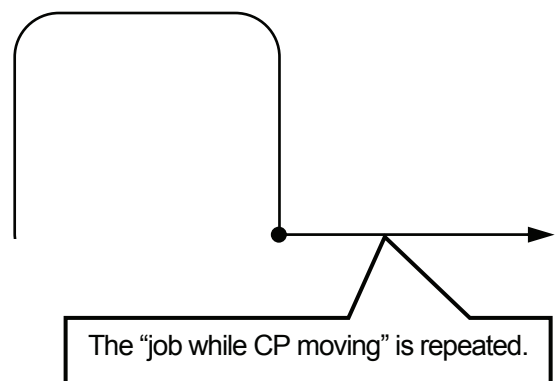

If there is the following sequence of point types, each point job is performed as illustrated below.

- P1: PTP Point
- P2: PTP Evasion Point
- P3: CP Start Point
- P4: CP Passing Point
- P5: CP Stop Point

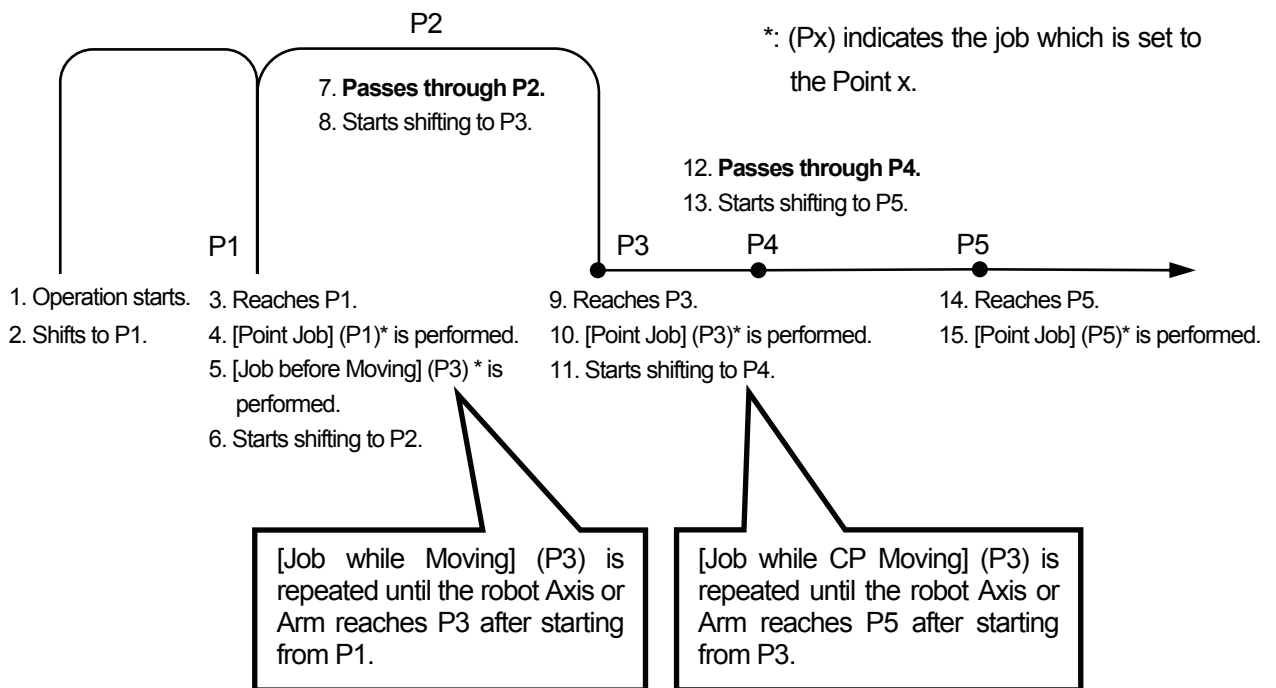

If the [Job before Moving] is set to the next point of the [PTP Evasion Point] point, the robot Axis or Arm starts the point job from the previous point of the [PTP Evasion Point] point. In the example above, the [Job while Moving] set to P3 is repeated while it is shifting from P1 to P3.

[Job while CP Moving] is repeated until the robot Axis or Arm reaches the next point ([CP End Point] or [CP Passing Point]). It passes the [CP Passing Point] and [CP Arc Point] while performing the point job. In the example above, the [Job while CP Moving] set to P3 is repeated while it is shifting from P3 to P5.

# PTP CONDITION (ADDITIONAL FUNCTION DATA)

If you wish to change the height of the arch motion or speed between certain points in a program, create additional function data [PTP Condition] and set it to the point where you wish to change the condition. The robot Axis or Arm shifts **only between the designated point and the next point** according to the set additional function data [PTP Condition] instead of the program data [PTP Condition].

The contents of the additional function data [PTP Condition] are exactly the same as those of the program data [PTP Condition].

In the PTP drive, the robot Axis or Arm shifts according to program data [PTP Condition], except from the points where additional function data [PTP Condition] is set .

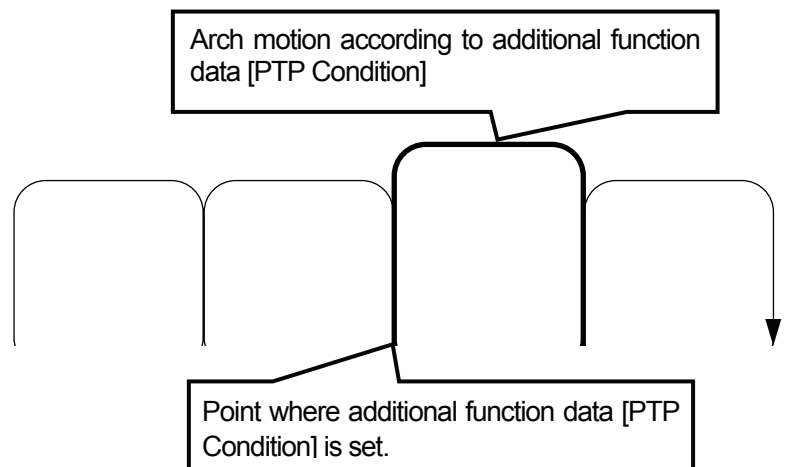

Point Type	PTP Point	CP Start Point	CP Passing Point	CP Stop Point	CP Arc Point	CP End Point	PTP Evasion Point	Work Home (PTP Point)	Work Home (CP Start Point)
○: Can be set, ×: Cannot be set	○	×	×	×	×	○	○	○	×

**TP** MENU [Additional Function Data Settings]  
[PTP Condition Settings]

**PC** [Data] → [Additional] → [PTP Condition]

Create additional function data [PTP Condition] and then set the number to the point where you wish to change the condition.

- Additional function data [PTP Condition] set to points in a program will not be changed even if you change the program data [PTP Condition].

# CP CONDITION (ADDITIONAL FUNCTION DATA)

If you wish to change the acceleration between certain points in a program, create additional function data [CP Condition] and set it to the point where you wish to change the condition.

The contents of the additional function data [CP Condition] are exactly the same as those of the program data [CP Condition].

If you set additional function data [CP Condition] to a [CP Start Point] point or [CP Stop Point] point, the robot Axis or Arm shifts according to the additional function data [CP Condition] until it reaches the next point ([CP End Point] or [CP Stop Point]). In the CP drive (from [CP Start Point] to [CP End Point]), the robot Axis or Arm shifts according to the program data [PTP Condition], except from the points where additional function data [CP Condition] is set.

Point Type	PTP Point	CP Start Point	CP Passing Point	CP Stop Point	CP Arc Point	CP End Point	PTP Evasion Point	Work Home (PTP Point)	Work Home (CP Start Point)
O: Can be set, x: Cannot be set	x	O	x	O	x	x	x	x	O

**TP** MENU [Additional Function Data Settings]  
[CP Condition Settings]

**PC** [Data] → [Additional] → [CP Condition]

Create the additional function data [CP Condition] and set the number to the point where you wish to change the condition.

- Additional function data [CP Condition] set to points in a program will not be changed even if you change the program data [CP Condition].

# TOOL DATA

If you wish to change the tool center position or the tool unit between certain points in a program, or when the tool weight will be changed during a pick-and-place operation, set additional function data [Tool Data] to the first point in the block of points

Point Type	PTP Point	CP Start Point	CP Passing Point	CP Stop Point	CP Arc Point	CP End Point	PTP Evasion Point	Work Home (PTP Point)	Work Home (CP Start Point)
○: Can be set, ×: Cannot be set	○	○	×	×	×	×	×	○	○

The contents of the additional function data [Tool Data] are exactly the same as those of the program data [Tool Data].

There are the following four settings in [Tool Data]:

- Tool Weight
  - TCP-X: X-direction distance from the standard tool position (R-Axis center) to the tool center point
  - TCP-Y: Y-direction distance from the standard tool position (R-Axis center) to the tool center point
  - TCP-deltaZ: Z-direction distance from the registered tool center point to the current tool center point
- 
- [TCP-X] is represented as [L2] and [TCP-Y] is represented as [L1] for the JSR4403N (3-Axis model of the JSR4400N Series).

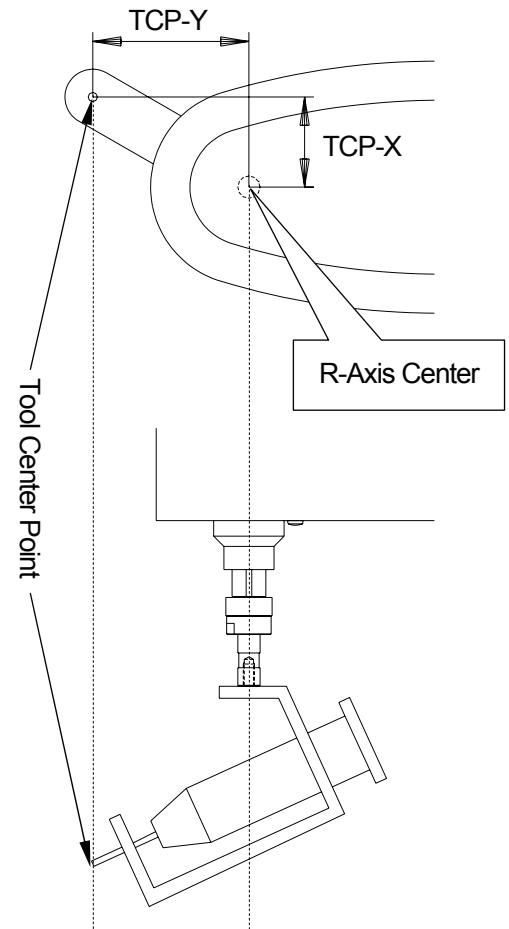

If you select [Direct TCP-XY Setting], you can calculate the values of [TCP-X] and [TCP-Y] by pointing at the same point twice (from different R-Axis angles) using the tool center point.

For the JSR4403N, if you select [Direct TCP-XY Setting], you can calculate the values of [L2] and [L1] by pointing at the same point twice (Righty and Lefty)\* using the tool center point.

If you select [Copying to All Programs], you can copy the registered tool data to the default program data and the program data in all programs.

You can change the tool data only between certain points by changing additional function data [Tool Data].

\*: Righty and Lefty indicate the directions in which the robot Arm turns. For details of the Axis coordinate system, see the operation manuals *Basic Instructions* ("COORDINATE SYSTEM") and *Teaching Pendant Operation*.

---

**TP** → **MENU** [Additional Function Data Settings]  
[Point Tool Data Settings]

**PC** → [Data] → [Additional] → [Tool Data]

Create additional function data [Tool Data] and set the number to the point where you wish to change the condition.



# PALLET ROUTINE

Create additional function data [Pallet Routine] and set it to the PTP point(s) where you wish to place the workpieces at the same point or at regular intervals. If you wish to draw a regular pattern repeatedly, set additional function data [Pallet Routine] to the [CP Start Point] point. The usage of the pallet at the CP start point differs from the usage at the PTP points.

The pallet is the offset of the coordinates from the standard point. It has a counter function. The offset changes as the counter proceeds.

You can set a name to each additional function data [Pallet Routine]. Press the **EDIT** key on the Pallet Routine Data settings screen. The Name editing screen will appear.

Point Type	PTP Point	CP Start Point	CP Passing Point	CP Stop Point	CP Arc Point	CP End Point	PTP Evasion Point	Work Home (PTP Point)	Work Home (CP Start Point)
○: Can be set, ×: Cannot be set	○	○	×	×	×	×	○	○	○

## Pallet Routine Type

There are the following six types of pallet routine:

1. Plane Pallet (two-dimensional repetition): 5 Rows, 4 Columns

P0				Pa
Pb				

2. Cubic Pallet (three-dimensional repetition): 4 Rows, 5 Columns, 6 Tiers

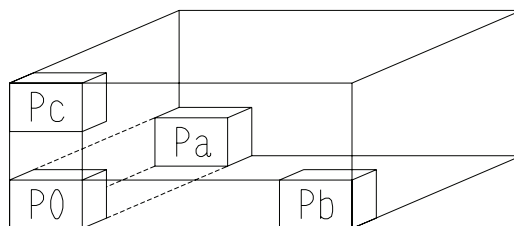

3. Row (one-dimensional repetition): 5 Rows

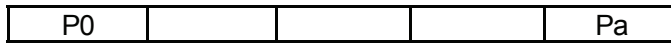

4. 1 Point Repeat (zero-dimensional repetition)



For [1 Point Repeat], the coordinates of the point will be the pallet routine job point.

5. Circle Pallet (two-dimensional repetition): Increment angle 180deg

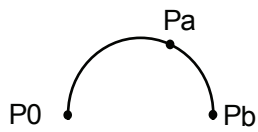

6. Repeat by Camera A210/A110

For details of the pallet routine for the camera function, refer to the *Camera & Sensor Functions* operation manual (optional).

## **Parameter**

Depending on the pallet routine type, you may need to enter parameters.

You need to select either [Auto Increment] or [Increment by Point Job] for all the pallet routines.

If you select [Auto Increment], the count of the pallet counter will automatically increase one by one.

If you select [Increment by Point Job], you need to set the commands for resetting the pallet counter to the point job data.

Pallet Routine Type	Parameter						
Plane Pallet	Row	Column		P0	Pa	Pb	
Cubic Pallet	Row	Column	Tier	P0	Pa	Pb	Pc
Row	Row			P0	Pa		
1 Point Repeat	(Repeat) Times						
Circle Pallet	(Repeat) Times	Step Angle		P0	Pa	Pb	

P0, Pa, Pb, and Pc are coordinates to calculate the distance between the job points. Each coordinate in the pallet is the total of the offsets (results of the following formulas) and the **coordinates of the point**.

$$(Pa - P0)/(Value\ of\ Row - 1) \times Value\ of\ Row\ counter$$

$$(Pb - P0)/(Value\ of\ Column - 1) \times Value\ of\ Column\ counter$$

$$(Pc - P0)/(Value\ of\ Tier - 1) \times Value\ of\ Tier\ counter$$

For example, if you set the following pallet to Point 01 (X: 50, Y: 20, Z: 30),

### **Pallet Routine Type: Row (5 Rows)**

P0				Pa
X: 10				X: 110
Y: 100				Y: 100
Z: 0				Z: 0

The actual job points will be as follows:

### **Pallet Routine Type: Row (5 Rows)**

Row 1	Row 2	Row 3	Row 4	Row 5	
X: 50	X: 75	X: 100	X: 125	X: 150	$50+(110-10)/(5-1) \times C$
Y: 20	Y: 20	Y: 20	Y: 20	Y: 20	$20+(100-100)/(5-1) \times C$
Z: 30	Z: 30	Z: 30	Z: 30	Z: 30	$30+(0-0)/(5-1) \times C$

Points P0, Pa, Pb, and Pc are necessary because the distances between the points are used to calculate the coordinates of each job point in the pallet.

Put briefly, any numbers can be set to the coordinates of P0, Pa, Pb, and Pc as long as the distances are the same.

The order of job points in the pallet varies according to the settings of the coordinates P0, Pa, or Pb as below. You can also set an inclined pallet.

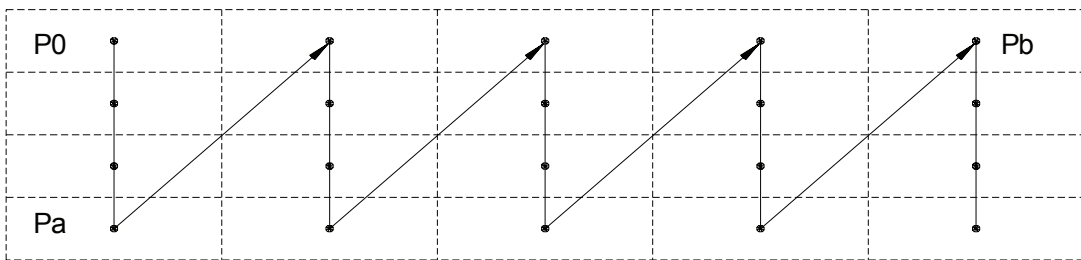
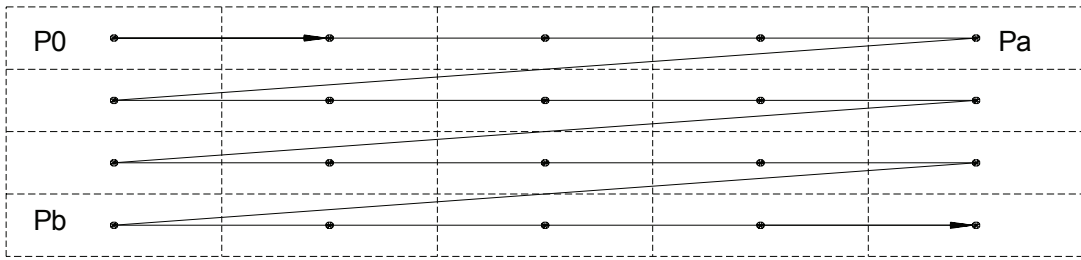

## **Pallet Routine by Point Job Data Command**

There are two types of pallet control functions for [Pallet Routine]. One is [Auto Increment], where the count is increased automatically. (The robot Axis or Arm shifts to the next point in the pallet one point at a time.) The other is [Increment by Point Job], which does not increase the count unless point job data which renews the counter is set. (The robot Axis or Arm does not shift to the next point in the pallet.) They can be switched.

If you select [Auto Increment], you don't need to set a point job command to control the pallet. The robot Axis or Arm automatically shifts to the next point one at a time and the pallet counter is reset automatically. When the count reaches maximum, the robot Axis or Arm shifts to the next point. (If [Pallet Routine] is set to Point 03, the robot Axis or Arm shifts to Point 04.)

There are three types of point job data commands to control the pallet:

loopPallet (LOOP):	Adds 1 to the count of the pallet counter. If the count does not reach maximum, the robot Axis or Arm shifts to the designated point.
resPallet (RESET):	Resets the counter to 0.
incPallet (INCREMENT):	Adds 1 to the count of the pallet counter.

For example, the following commands get the same result:

Add 1 to the counter of Pallet 10. If the count reaches maximum, shift to the next command.  
If not, shift to Point 03.

### **With LOOP**

```
loopPallet 10,3
```

### **Without LOOP**

```
incPallet 10  
if  
  Id #palletFlag(10)  
else  
  goPoint PTP0,3  
endif
```

## **Pallet Routine at PTP Points**

Set additional function data [Pallet Routine] to the PTP point(s) if you wish to place workpieces at the same point or at regular intervals.

For example, set the [Auto Increment] pallet to the PTP point(s) according to the following procedures:

1. Register [Pallet Routine].
2. Set the [Pallet Routine] number to the point data.

The robot Axis or Arm will then shift as illustrated below.

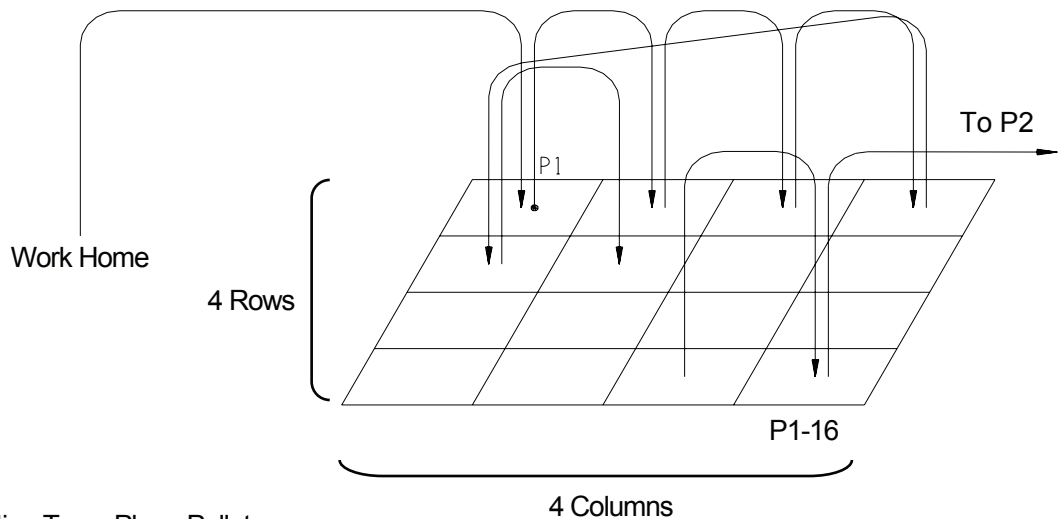

Pallet Routine Type: Plane Pallet

Counter Control: Auto Increment

Row: 4

Column: 4

**TP** **MENU** [Additional Function Data Settings]  
[Pallet Routine Data Settings]

**PC** [Data] → [Additional] → [Pallet Routine]

Create additional function data [Pallet Routine] and set the number to the desired point.

## Pallet Routine at CP Start Point

Register the following points P1 – P5, and then set [Pallet Routine] to P1 ([CP Start Point]).

- P1: CP Start Point (start of dispensing)
- P2: CP Arc Point
- P3: CP Passing Point
- P4: CP Arc Point
- P5: CP End Point (end of dispensing)

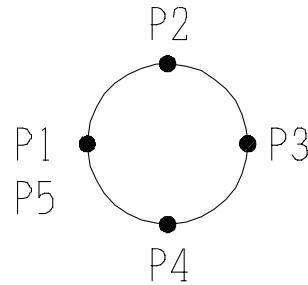

If you set the [Auto Increment] pallet to the [CP Start Point] (P1), the robot Axis or Arm will shift as illustrated below. The robot recognizes the sequence of points P1 – P5 ([CP Start Point]) – [CP End Point]) as a pattern and repeats the operation as many times as there are pallets.

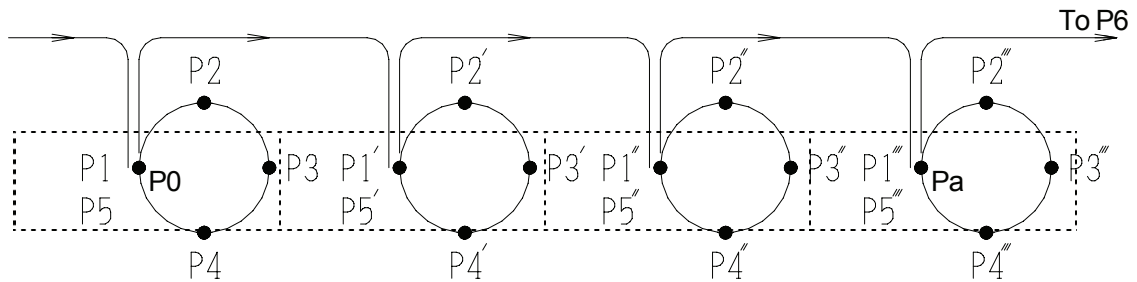

Pallet Routine Type: Row

Counter Control: Auto Increment

Row: 4

**TP** MENU [Additional Function Data Settings]  
[Pallet Routine Data Settings]

**PC** [Data] → [Additional] → [Pallet Routine]

Create additional function data [Pallet Routine] and set the number to the desired point.

## Circle Pallet

If you select [Circle Pallet] from the additional function data [Pallet Routine] types, you can use arc and circle pallets.

Designate any three points to determine the pallet size and execution sequence. You can divide a circle pallet by setting [Times].

You can make an arc pallet if you change [Step Angle].

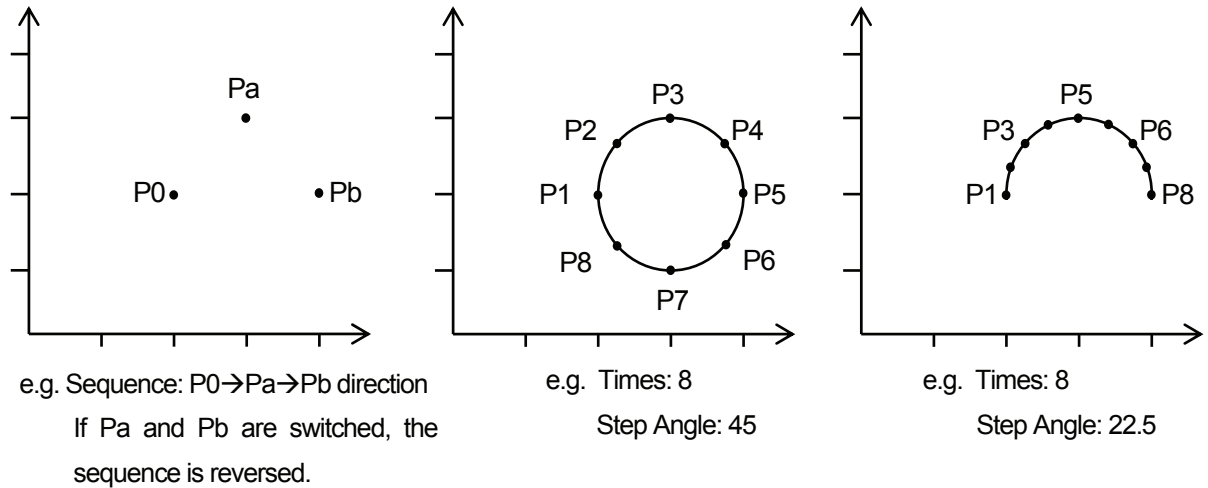

**TP** **MENU** [Additional Function Data Settings]  
[Pallet Routine Data Settings]

**PC** [Data] → [Additional] → [Pallet Routine]

Create additional function data [Pallet Routine] and set the number to the desired point.



## Pick-and-Place Operation in the Pallet

Register the pallet routine according to the following procedures:

1. Register [Pallet Routine].
2. Register [Point Job Data].
3. Set the [Pallet Routine] number to the point data.
4. Set the [Point Job] number to the point data.

### **Example 1: How to Place a Workpiece on the Pallet**

The tool unit picks up a workpiece at Point 01 (P1) and places it on the pallet set to Point 02 (P2), then shifts to the next point (P3) if the pallet becomes full.

The [Pallet Routine] settings are as follows:

Pallet Routine Number : 10  
 Pallet Routine Type: Plane Pallet  
 Counter Control:  
     Increment by Point Job  
 Row: 4  
 Column: 3

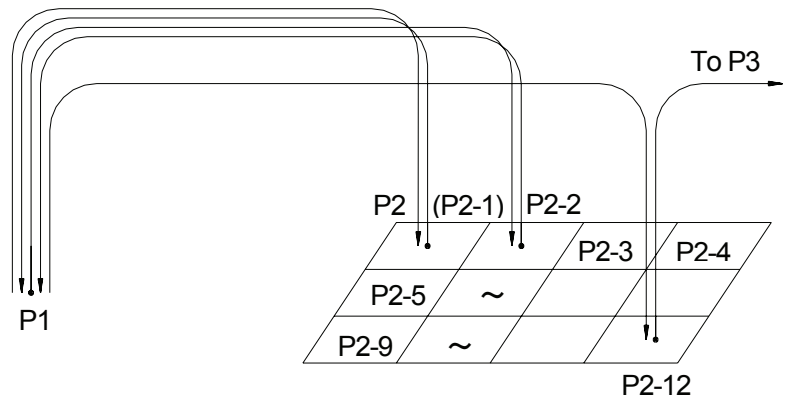

The tool unit is connected according to the following settings:

Picking up a workpiece: #genOut1 (I/O-1) is ON.  
 Placing a workpiece: #genOut1 (I/O-1) is OFF.

#### **Point Job Data 15**

set #genOut1	Pick up a workpiece.
--------------	----------------------

#### **Point Job Data 16**

reset #genOut1 loopPallet 10,1	Place (Release) a workpiece. Add 1 to the counter of Pallet 10. If the counter reaches maximum, go to the next command. (In this example, the point job is over because there are no more commands.) If not, shift to Point 01 (P1).
-----------------------------------	--

Point Job Data and Additional Function Data to Be Set	
Point 01 (P1)	Point 02 (P2)
Point Job Number 15	Point Job Number 16 Pallet Routine Number 10

### Example 2: How to Pick up a Workpiece from the Pallet

The tool unit picks up a workpiece on the pallet set to Point 01 (P1) and places it on Point 02 (P2). If all the workpieces are picked up and placed, the tool unit shifts to the next point (P3).

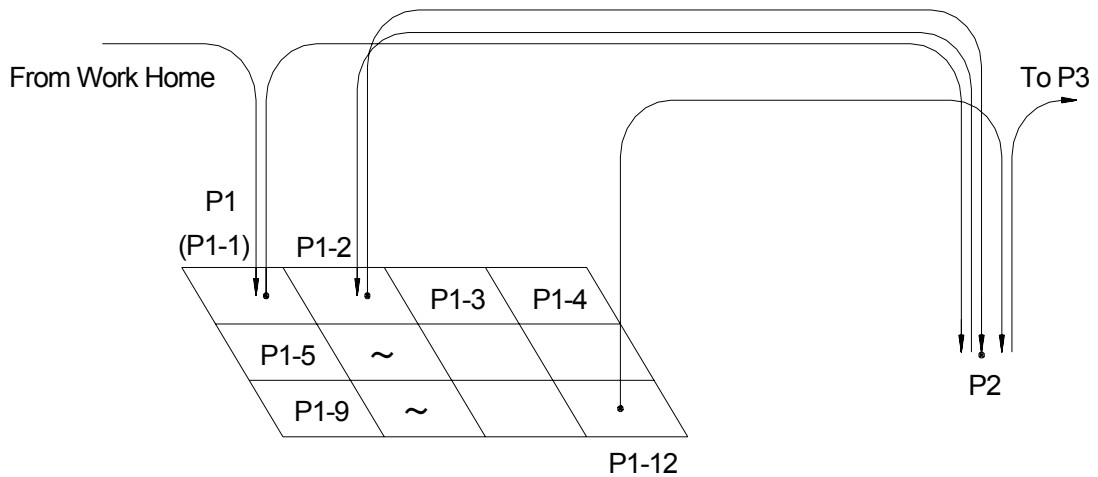

The [Pallet Routine] settings are as follows:

Pallet Routine Number: 10

Pallet Routine Type: Plane Pallet

Counter Control: Increment by Point Job

Row: 4

Column: 3

#### Point Job Data 5

set #genOut1	Pick up a workpiece.
--------------	----------------------

#### Point Job Data 6

reset #genOut1 loopPallet 10,1	Place (Release) a workpiece. Add 1 to the counter of Pallet 10. If the counter reaches maximum, go to the next command. (In this example, the point job is over because there are no more commands.) If not, shift to Point 01 (P1).
-----------------------------------	--

Point Job Data and Additional Function Data to Be Set	
Point 01 (P1)	Point 02 (P2)
Point Job Number 05 Pallet Routine Number 10	Point Job Number 06

### Example 3: How to Pick and Place a Workpiece between Pallets

This example explains how to set the point job data for a pick-and-place operation between two pallets of different sizes.

#### Conditions

- Pick up a workpiece from Pallet 10 set to Point 02 (P2) and place it on Pallet 11 set to Point 03 (P3).
- If the pickup pallet (Pallet 10) becomes empty, return to Point 01 (P1) and wait until the pallet is replaced.
- If the place pallet (Pallet 11) becomes full, shift to Point 04 (P4) and wait until the pallet is replaced.
- Pickup pallet: Pallet Routine Number: 10, Pallet Routine Type: Row, Counter Control: Increment by Point Job, Row: 3
- Place pallet: Pallet Routine Number: 11, Pallet Routine Type: Row, Counter Control: Increment by Point Job, Row: 4
- Command to pick up a workpiece: #genOut1 is ON.
- Command to place a workpiece: #genOut1 is OFF.
- Command to replace the pickup pallet: #genOut2 is ON.
- Pickup pallet replacement complete: #genIn2 is ON.
- Command to replace the place pallet: #genOut3 is ON.
- Place pallet replacement complete: #genIn3 is ON.

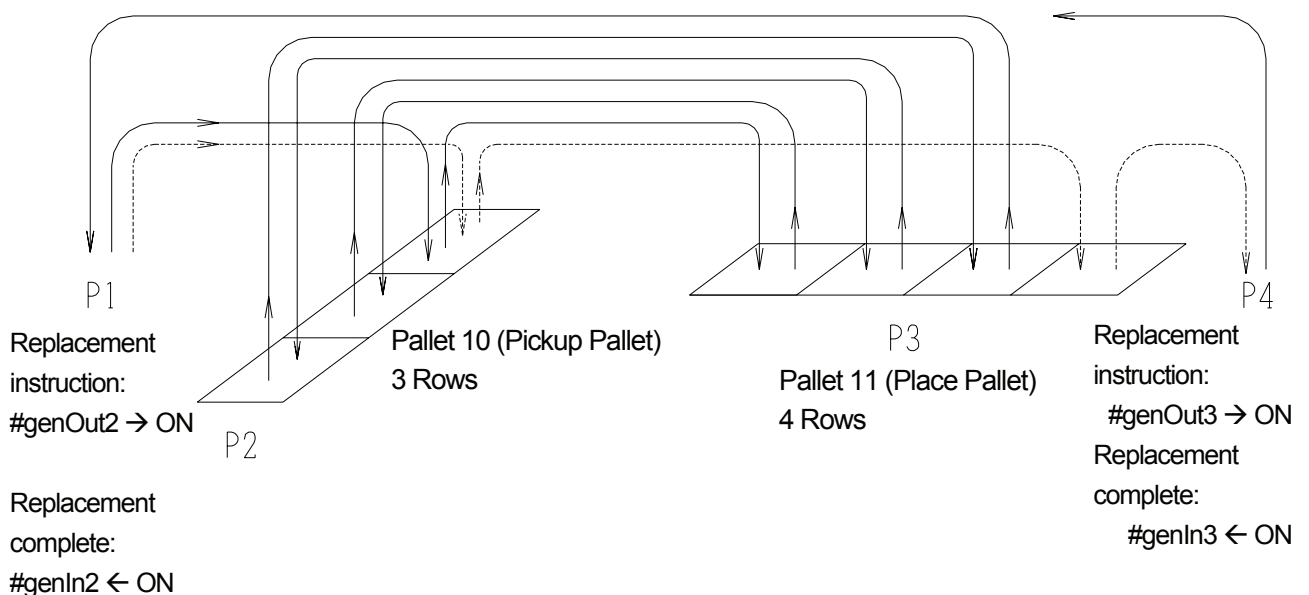

#### Point Job Data 05 (Set to P2)

set #genOut1

Pick up a workpiece.

### Point Job Data 06 (Set to P3)

```
reset #genOut1
incPallet 10
incPallet 11
if
  Id #palletFlag(11)
then
  goPoint PTP0,4
endif
if
  Id #palletFlag(10)
then
  goPoint PTP0,1
endif
goPoint PTP0,2
```

Place a workpiece.  
Add 1 to the counter of the pickup pallet.  
Add 1 to the counter of the place pallet.  
If  
the place pallet is full,  
  
shift to Point 04 (P4).  
  
If  
the pickup pallet is empty,  
  
shift to Point 01(P1).  
  
Shift to Point 02 (P2).

### Point Job Data 07 (Set to P4)

```
set #genOut3
waitCond
  Id #genIn3
endWait
reset #genOut3
if
  Id #palletFlag(10)
then
  goPoint PTP0,1
endif
goPoint PTP0,2
```

Turn on the place pallet replacement instruction signal.  
  
Wait for the place pallet replacement completed signal.  
  
Turn off the place pallet replacement instruction signal.  
If  
the pickup pallet is empty,  
  
shift to Point 01(P1).  
  
Shift to Point 02 (P2).

### Point Job Data 08 (Set to P1)

```
set #genOut2
waitCond
  Id #genIn2
endWait
reset #genOut2
```

Turn on the pickup pallet replacement instruction signal.  
  
Wait for the pickup pallet replacement completed signal.  
  
Turn off the pickup pallet replacement instruction signal.

Point Job Data and Additional Function Data to Be Set	
<b>Point 01 (P1)</b>	<b>Point 02 (P2)</b>
Point Job Number 08	Point Job Number 05 Pallet Routine Number 10 (Type: Row, Row: 3)

Point Job Data and Additional Function Data to Be Set	
<b>Point 03 (P3)</b>	<b>Point 04 (P4)</b>
Point Job Number 06 Pallet Routine Number 11 (Type: Row, Row: 4)	Point Job Number 07

## How to Terminate the Pallet Routine

In some cases, you may have to stop the pallet routine during operation. You can stop the pallet routine using point job data and a combination of *if* and *goPoint* commands.

If you want to restart the pallet routine from the beginning, you have to reset the pallet counter. Unless the counter is reset, the robot restarts operation from the point where it stopped operation.

To reset the pallet counter, set a reset command to the point job data. *resPallet* is the point job command to reset the pallet counter. If you enter a [Pallet Routine] number to the *resPallet* parameters, you can reset the counter of the designated pallet.

e.g. If an error has occurred (*#genIn1* is ON) during operation at Pallet 05 set to Point 01 (P1), the tool unit shifts to Point 03 (P3).

The robot sounds a buzzer and waits for a start signal at Point 03 (P3). If the robot receives the start signal and *#genIn1* is ON, it restarts operation from the point next to where the error occurred. If *#genIn1* is not ON, the robot restarts the pallet routine from the beginning.

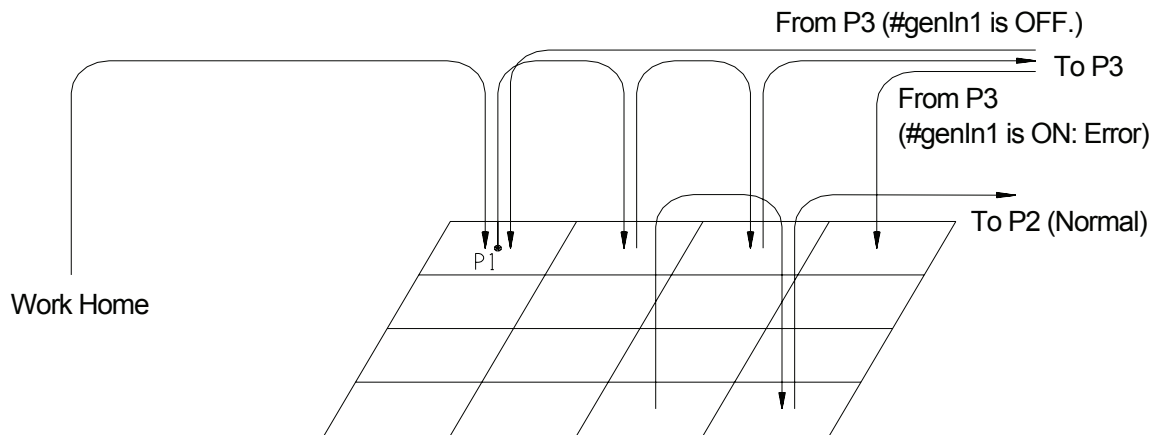

The [Pallet Routine] settings are as follows:

Pallet Routine Number: 5  
 Pallet Routine Type: Plane Pallet  
 Counter Control: Increment by Point Job  
 Row: 4  
 Column: 4

### Point Job Data 20

```
set #genOut3
waitCondTime 800
reset #genOut3
if
  Id #genIn1
then
  goPoint PTP2,3
endif
```

```

} Turn on #genOut3.
  in 0.8 seconds,
} Turn off #genOut3.
} (Normal job at Point 01)
if
  #genIn1 is ON (error),
  shift to Point 03 (P3).
```

### Point Job Data 21

```
waitStartBZ
if
  Id #genIn1
then
  goPoint PTP2,1
else
  resPallet 5
  goPoint PTP2,1
endif
```

Sound buzzer and wait for a start signal.

If

#genIn1 is ON (error),  
shift to Point 01 (P1).

#genIn1 is not ON (error),  
reset the counter of Pallet Number 5 and  
shift to Point 01 (P1).

- If #genIn1 is ON (error), the tool unit shifts to the point next to where the error occurred after returning to P1 since the counter pallet is not reset. If genIn1 is not ON (normal: From P2 to P3), the tool unit shifts to the first point in the pallet after returning to P1 since the pallet counter is reset.

Point Job Data and Additional Function Data to Be Set	
Point 01 (P1)	Point 03 (P3)
Point Job Number 20 Pallet Routine Number 05	Point Job Number 21

# WORKPIECE ADJUSTMENT (NUMERIC ADJUSTMENT)

You can shift the designated point position (coordinates) by entering numbers.

Create additional function data [Workpiece Adjustment] and set it to the point which you wish to shift.

- For details of [Workpiece Adjustment] with a camera or a distance sensor, refer to the *Camera & Sensor Functions* operation manual.

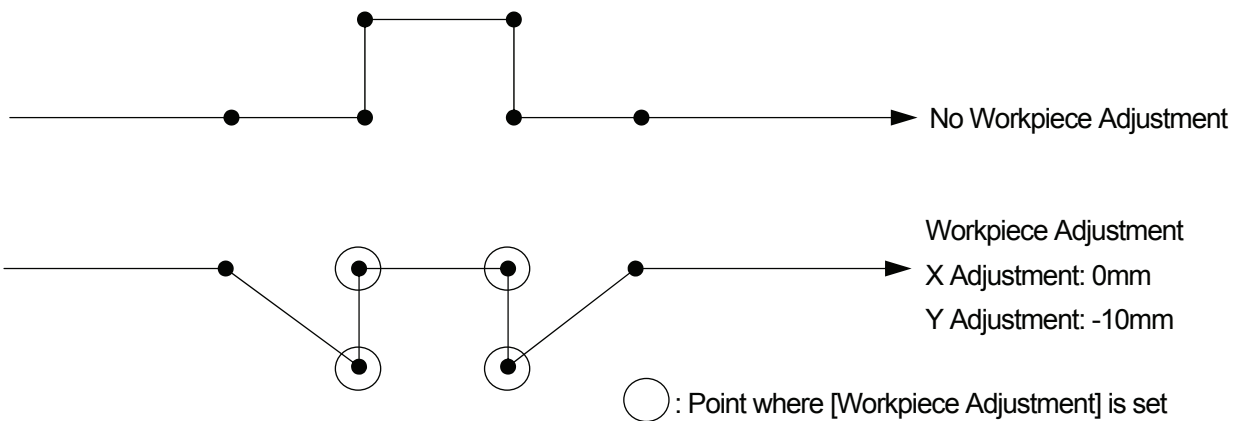

Point Type	PTP Point	CP Start Point	CP Passing Point	CP Stop Point	CP Arc Point	CP End Point	PTP Evasion Point	Work Home (PTP Point)	Work Home (CP Start Point)
○: Can be set, ×: Cannot be set	○	○	×	×	×	×	×	○	○

**TP** MENU [Additional Function Data Settings]  
[Workpiece Adjustment Settings]

**PC** [Data] → [Additional] → [Work Adjustment]

Create additional function data [Workpiece Adjustment Settings] and set the number to the point where you wish to change the condition.



- The sequence of points [CP Start Point] – [CP End Point] is handled as a block of points. If you set additional function data [Workpiece Adjustment] to the [CP Start Point] point, the set [Workpiece Adjustment] affects all the CP points, from [CP Start Point] to [CP End Point].
- You can set the designated work adjustment number to the designated array (block) of points. If the [Work Adjustment] is already set to a point in the block, it will be replaced by the designated work adjustment number.



**EDIT**

[Block Editing]

Enter a Block Start Number.

Enter a Block End Number.

[Work Adjustment Number]

- You can set a name for each additional function data [Workpiece Adjustment]. Press the **EDIT** key on the Workpiece Adjustment settings screen. The Name editing screen will appear.

# EXECUTE CONDITION

You can change the shifting route of the tool unit according to the designated conditions.  
In this example, a sensor is connected to I/O-1.

Set the sensor result at Point 02 (P2) to #genIn1 (I/O-1) as *ON* and *OFF*, and save it in #mv(1) (built-in Boolean variable). Then set additional function data [Execute Condition] to Point 04 (P4) to execute operation if #mv(1) is ON and to Point 05 (P5) to execute operation if #mv(1) is OFF.

Under the settings above, the shifting route will be as follows:

- #mv(1) is ON: P3 → P4 → P6
- #mv(1) is OFF: P3 → P5 → P6

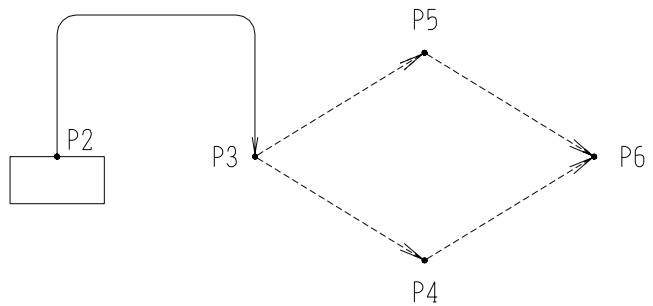

The [Execute Condition] settings are as follows:

### For Point 04 (P4)

Id #mv(1)

### For Point 05 (P5)

Idi #mv(1)

Point Type	PTP Point	CP Start Point	CP Passing Point	CP Stop Point	CP Arc Point	CP End Point	PTP Evasion Point	Work Home (PTP Point)	Work Home (CP Start Point)
O: Can be set, ×: Cannot be set	○	○	○	○	○	○	○	○	○

**TP** MENU [Additional Function Data Settings]  
[Execute Condition Settings]

**PC** [Data] → [Additional] → [Execute Condition]

Create additional function data [Execute Condition] and set the number to the point where you wish to change the condition.

# TAG CODE

You can set a value (tag code) to a point. The tag code can be output to I/O-H (only for the JS Series), I/O-SYS, I/O-1, and free Boolean variables #mv (1 – 99) and #mkv (1 – 99) by a *dataOut* command. For example, if you set different values to multiple points as [Tag Code], you can output different values by using the same point job data.

Point Type	PTP Point	CP Start Point	CP Passing Point	CP Stop Point	CP Arc Point	CP End Point	PTP Evasion Point	Work Home (PTP Point)	Work Home (CP Start Point)
O: Can be set, x: Cannot be set	O	O	O	O	O	O	x	O	O

**TP** CURSOR↓ (Display a blank line.)  
[Tag Code]

**PC** [Tag Code] (Last line on the main screen)

## Point Job Data

Use the *dataOut* command to output the tag code.

When you register point job data, select a command category [ON/OFF Output Control] on the Category selection screen. Then select the output command [dataOut] and [Output Tag Code] in order. The *dataOut* command requires two parameters: [Output Bit Number] (numbers of I/O to output) and [IO-xx Output Number] (the smallest number in the I/O-xx to output; for example, select 8 if you use from #genOut8 to #genOut10.)

### Example:

<b>Designation</b>	<b>Command</b>	<b>Output</b> 6 = 110 (binary digit)
Tag Code: 6		#genOut8: 0 (OFF)
Output Bit Number: 3	DataOut #point_TagCode,#genOut8,3	#genOut9: 1 (ON)
IO-xx Output Number: 8		#genOut10: 1 (ON)

- I/O numbers and free Boolean variables should be sequential.
- You can use from 1 up to 31 as [Output Bit Number]. However, you cannot output to different types of I/O. For example, if you set [Output Bit Number] to [20] from #genOut14, the excess digits will be omitted (because the maximum #genOut is 22 for the JS and JSG Series). If [Output Value] does not fall within [Output Bit Number], the excess digits will also be omitted.

**Example:**

<b>Designation</b>	<b>Command</b>	<b>Output</b>
Tag Code: 14		14 = 1110 (binary digit)
Output Bit Number: 3	dataOut #point_TagCode,#genOut8,3	#genOut8: 0 (OFF)
IO-xx Output Number: 8		#genOut9: 1 (ON)
		#genOut10: 1 (ON)
		: 1 (Omitted)

**MEMO**

**Janome Sewing Machine Co., Ltd.**  
**Industrial Equipment Sales Department**  
**Postal Code: 193-0941**  
**1463 Hazama-machi, Hachioji-shi, Tokyo, Japan**  
**Tel: +81-42-661-6301**  
**Fax: +81-42-661-6302**

The specifications of the robot or the contents of this manual may be modified without prior notice to improve its quality.

No part of this manual may be reproduced in any form, including photocopying, reprinting, or translation into another language, without the prior written consent of JANOME.

©2009, JANOME Sewing Machine Co., Ltd., All rights reserved.

970802107 as of 2007-09

8 January 2009