



HPS Overview

S. Stepanyan (JLAB)

HPS Review

SLAC, January 18, 2019

Outline

- Search for Dark sector and portals
- HPS in Hall-B at Jefferson Lab
- Progress since the first proposal
- Analysis results, publications
- First production run:
 - Tracker and trigger upgrades
 - Beamline and installation
- Parameter space, competition and reach
- Summary

Dark Sectors and portals

- The astrophysical evidence for Dark Matter is compelling, but so far, there's no proof DM has been produced in particle physics experiments, interacted with sensitive detectors, or been seen annihilating or decaying.
- The existence of a low mass dark sector, which is as yet undiscovered because of the very weak couplings, is predicted by many extensions of the Standard Model
- Dark sectors may include mediator particles which couple to the SM via a portal. The vector portal is the most viable for thermal models of light DM. The dark (or heavy) photon is the mediator
- New models, astrophysical observations, and existing experimental anomalies point to the 1 MeV to 1 GeV mass scale as a high-value target region for dark matter and dark mediator searches
- The Heavy Photo Search experiment at Jefferson lab searches in a unique and promising region for the vector portal mediators.

The Vector “Portal” – $U(1)_d$

The simplest case the dark (or heavy) photon that couples to the Standard Model photon through the kinetic mixing.

B. Holdom, Phys. Lett. B 166, 196 (1986).

Coupling

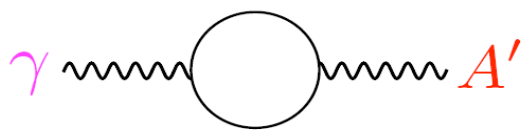

$$\epsilon \sim 10^{-4} - 10^{-2}$$

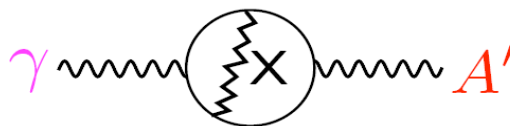

$$\epsilon \sim 10^{-5} - 10^{-3}$$

(if SM unifies in a GUT)

$$\epsilon^2 = \frac{\alpha'}{\alpha}$$

α is the fine-structure constant

Mass – less constrained, if DM is light and accounts for the relic mass density, the region 1 MeV – 1 GeV is well motivated for dark vector mediator

Parameter space for LDMP

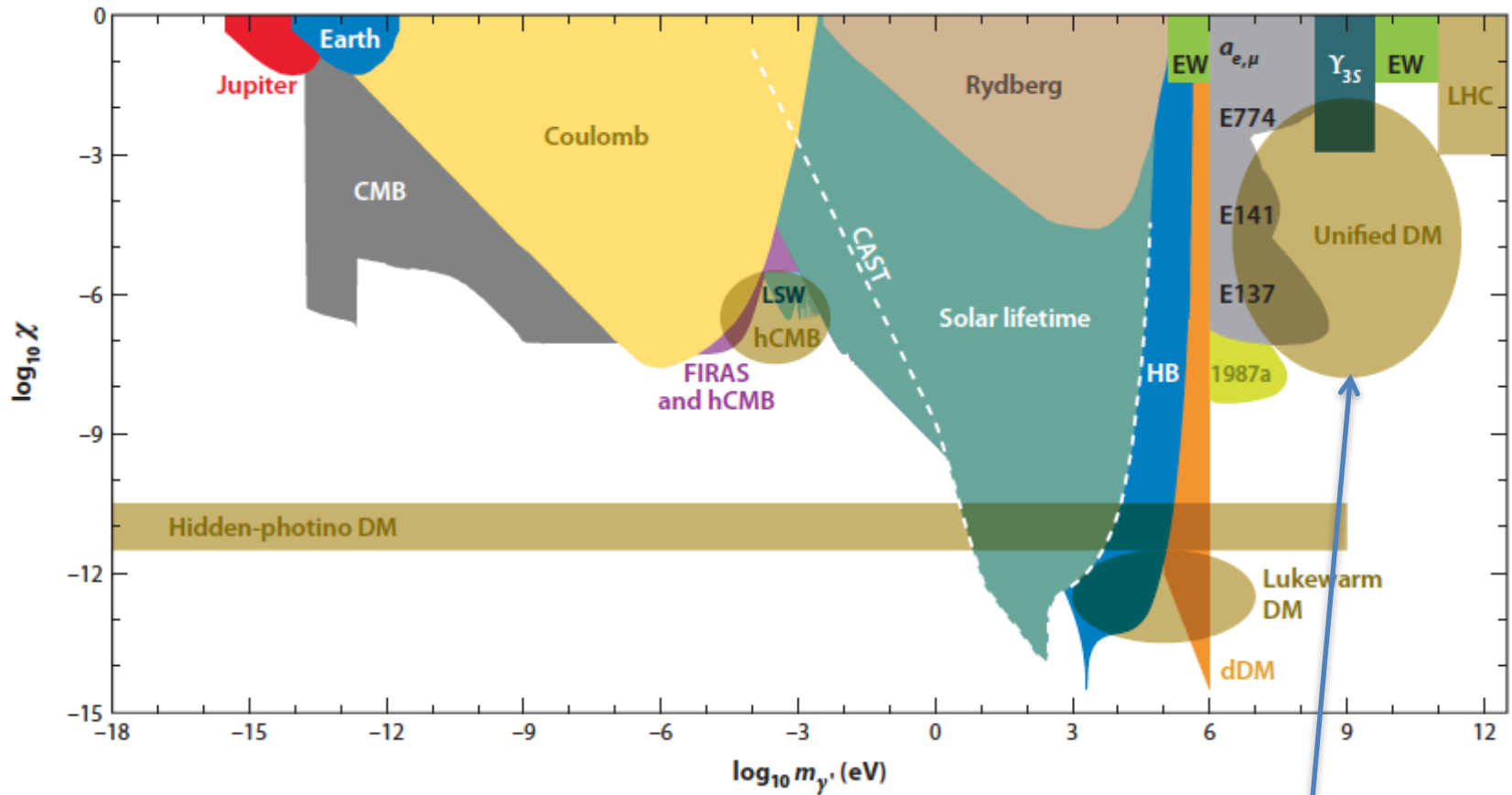

Jaeckel and Ringwald, Annu. Rev. Nucl. Part. Sci. 2010.60:405-437

Hidden sector photons

Where and how to search for dark photons

A' can be electroproduced the same way as radiative tridents in the fixed target experiments and can decay to SM particles (*J.D. Bjorken, R. Essig, P. Schuster, and N. Toro, Phys. Rev. D80, 2009, 075018*)

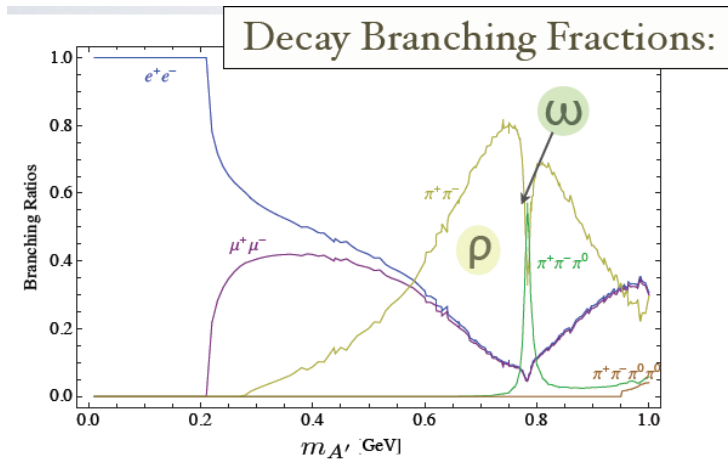
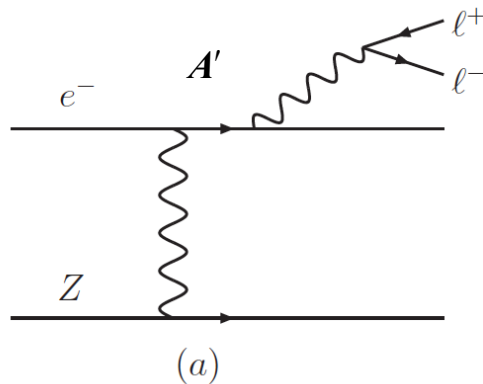

Kinematics is very different from massless photon bremsstrahlung, the heavier product takes most of the beam energy.

$$\frac{d\sigma}{dx} \propto \frac{\alpha^3}{\pi} \frac{\epsilon^2}{m_e^2 \cdot x \cdot m_A^2 (1-x)/x}$$

$$x = \frac{E_A}{E}$$

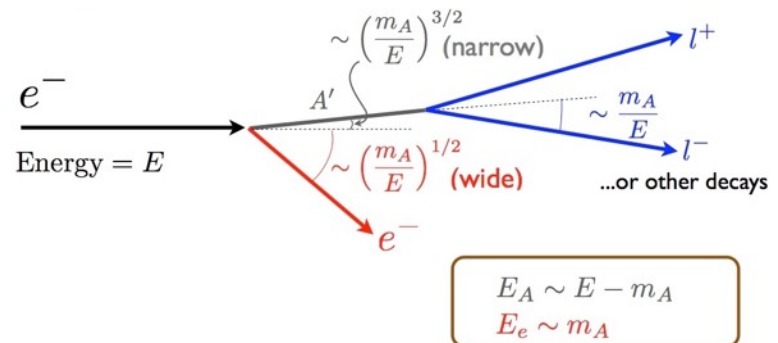

Heavy Photon Search experiment at JLAB

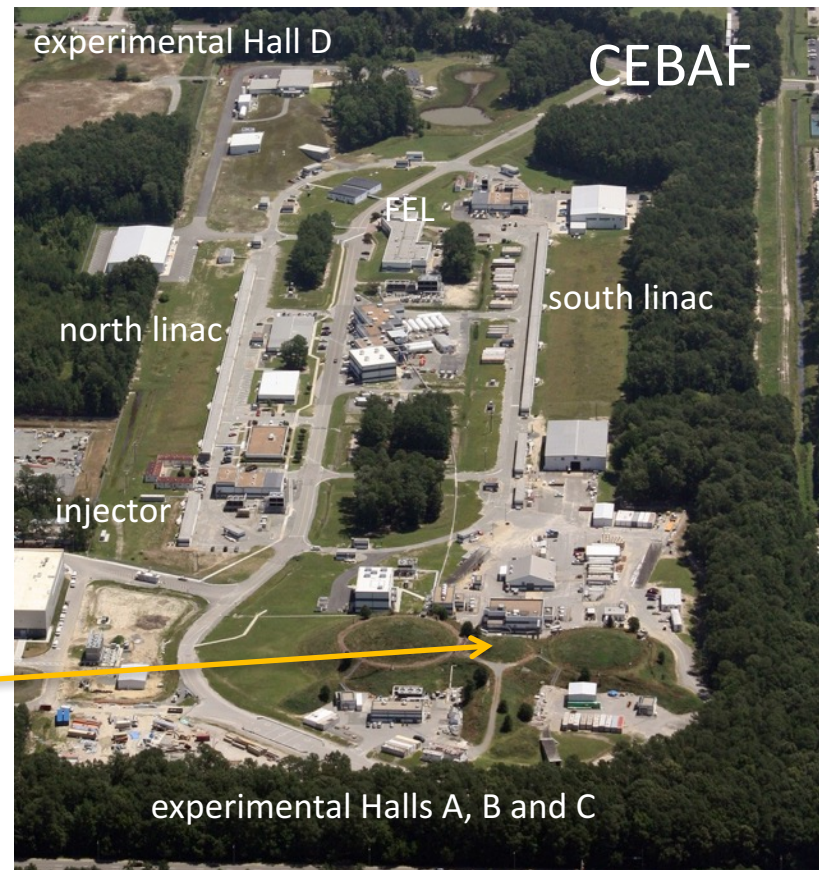
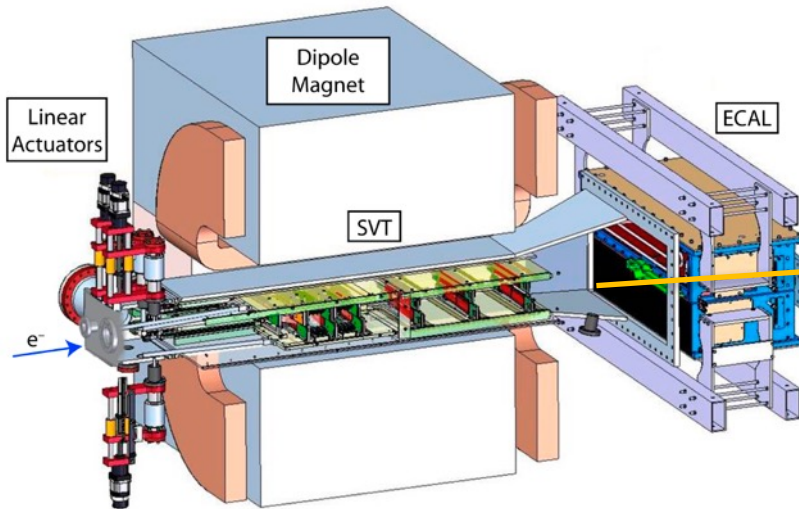

HPS is managed by an international collaboration of more than 60 scientists from USA, France, Italy, UK, and Armenia.



Heavy Photon Search strategies

HPS searches for hidden sector gauge bosons (“heavy photons”) in a unique region of parameter space by exploiting both separated vertex and invariant mass signatures.

Resonance search

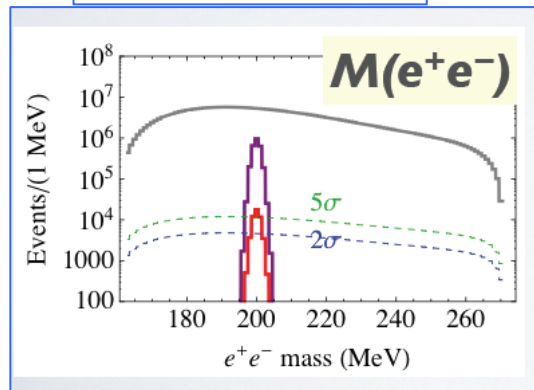

If α' is large A' can be seen as a peak on top of copious EM background

Displaced decay vertex search

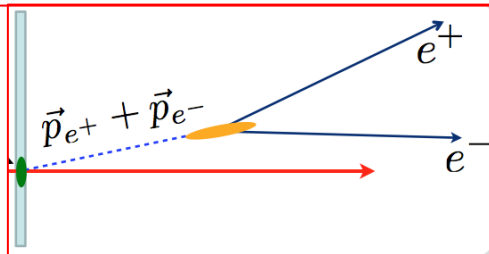

If α' is small A' lifetime is long, many will decay downstream of the production vertex

Parameter space at the time of the proposal

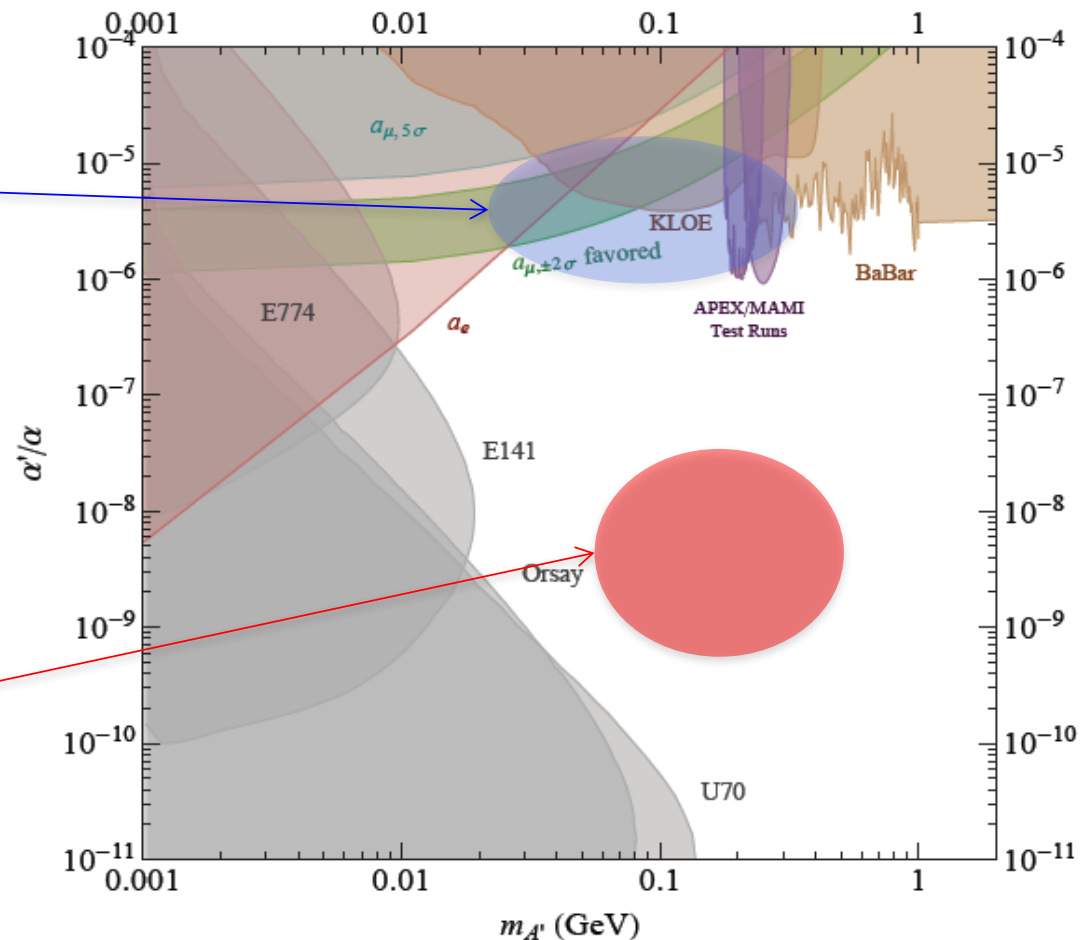

HPS apparatus - SVT

Precise measurements of momentum and production vertex

- Was installed in the vacuum inside the analyzing magnet
- First layer is located at **10 cm** from the target, the silicon in the first layer is only **0.5 mm** from the center of the beam
- First 3-layers are retractable
- Silicon is actively cooled to remove heat and retard radiation damage
- The sensors have 60(30) μm readout(sense) pitch (hit position resolution $\sim 6 \mu\text{m}$)
- The sensors are read out continuously at 40 MHz using the APV25 chip
- Tracks are reconstructed starting from **15 mrad** scattering angles

Layer number	1	2	3	4	5	6
nominal z , from target (cm)	10	20	30	50	70	90
Stereo Angle (mrad)	100	100	100	50	50	50
Bend-plane resolution (μm)	≈ 60	≈ 60	≈ 60	≈ 120	≈ 120	≈ 120
Non-bend resolution (μm)	≈ 6	≈ 6	≈ 6	≈ 6	≈ 6	≈ 6
Number of sensors	4	4	4	8	8	8
Nominal dead zone in y (mm)	± 1.5	± 3.0	± 4.5	± 7.5	± 10.5	± 13.5
Module power consumption (W)	6.9	6.9	6.9	13.8	13.8	13.8

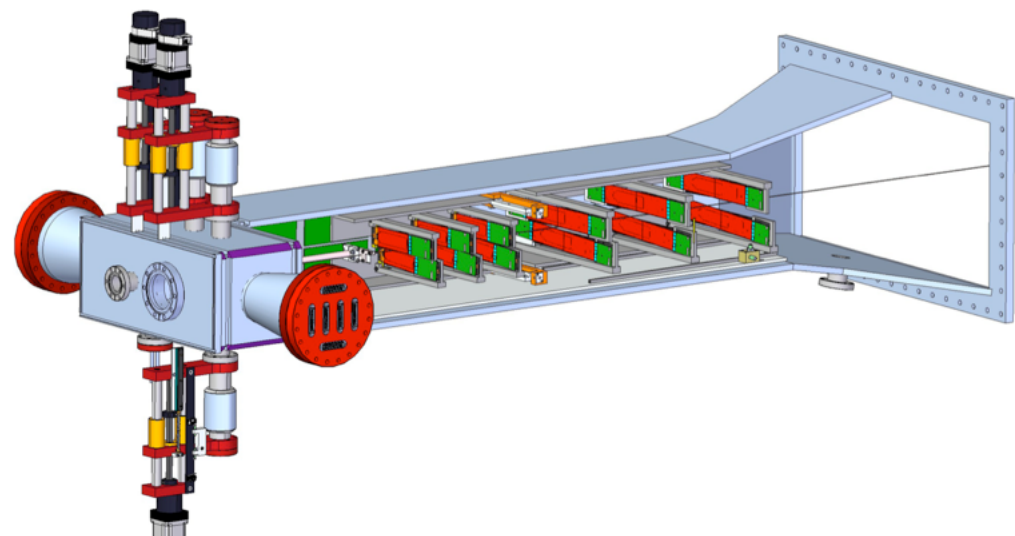

HPS apparatus - ECal

- Lead-tungstate calorimeter with 442 16 cm long crystals (1.3x1.3 cm² cross section) with APD readout (Hamamatsu S8664-55)
- In each half, crystals are arranged in rectangular formation in 5 layers, 4 layers have 46 crystals and the one closest to the beam has 37 crystals
- Modules are located inside the thermal enclosure with temperature stability <1°C
- Energy resolution $\sigma/E \approx 4.5\%/ \sqrt{E}$

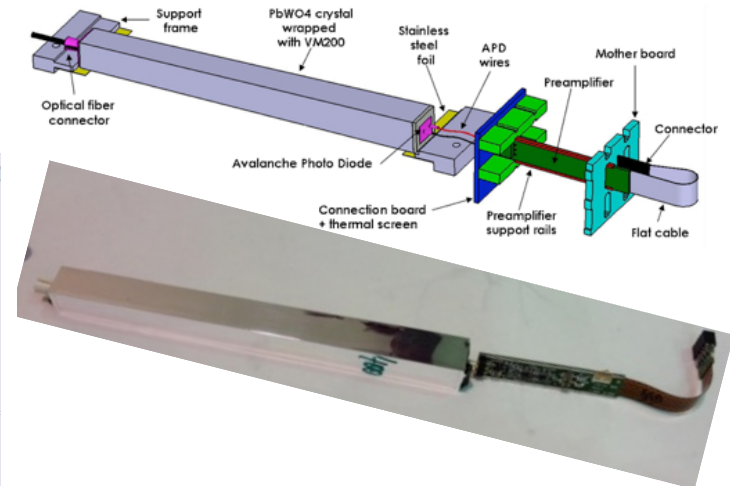
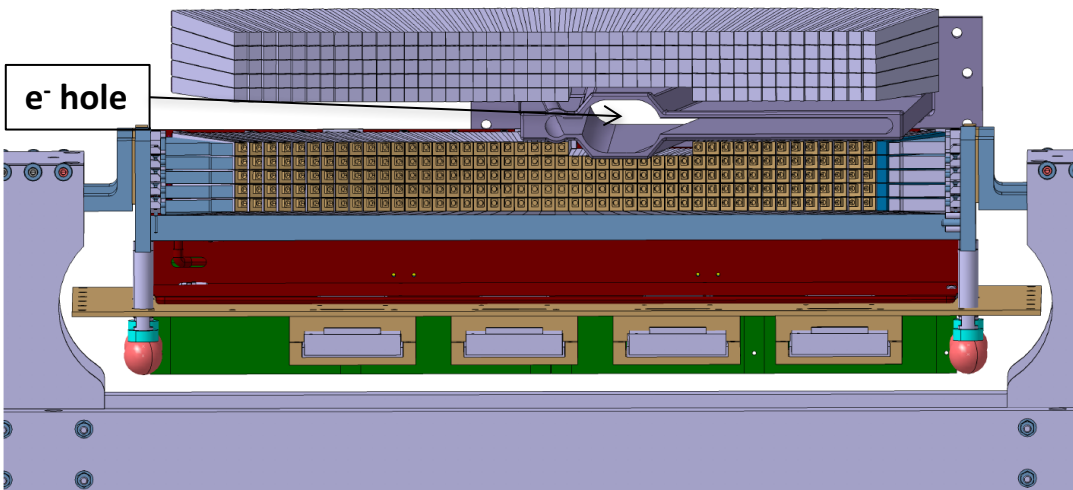
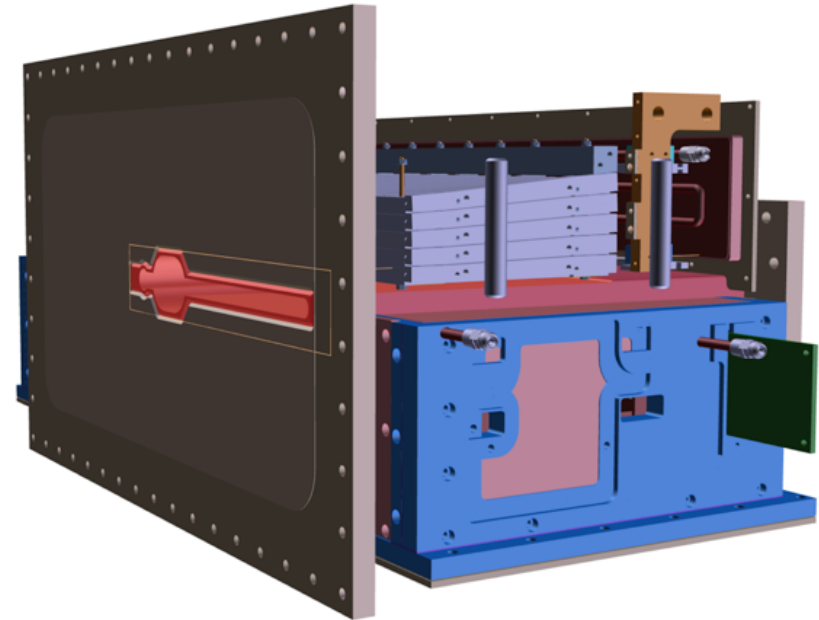

DAQ and the trigger

- Two DAQ architectures, ATCA for SVT (SLAC) and VXS-FADC250 for ECal (JLAB)
- JLAB CODA DAQ software for trigger and readout
- Trigger is defined by ECal and based on JLAB FADC250, where samples the analog signal from each ECal channel every 4 ns
- Modules with energy above threshold are processed for the trigger
- Pulse height, spatial and timing information from each crystal were available for the trigger decision. Energy and position cuts are applied to define trigger(s)
- The whole system run with trigger rates of 20 kHz with with very small dead time, <10%
- In 2015/2016 engineering runs, two clusters selected in opposite modules with energy-position cuts was used as production trigger
- The upgraded trigger system will use a single cluster in the calorimeter, with position dependent energy cut and tagged with signal from the new scintillation hodoscope.

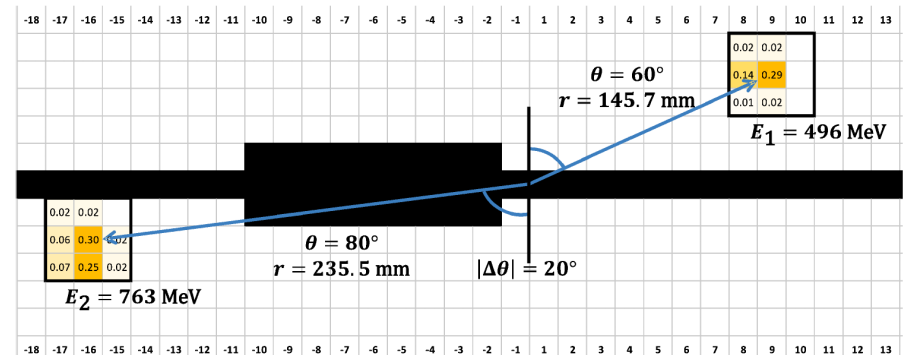

More in Sergey Boyarinov's and Ryan Herbst's talks

HPS evolution

January 2011

Proposal: PR12-11-006

Scientific Rating: Unrated

Recommendation: C2, i.e. the PAC conditionally approves this proposal contingent on the success of the test run. It feels that the test run should be carried out as early as possible (ideally before the 6 GeV shutdown), so that the full experiment can be carried out in a timely manner.

June 2012

Proposal: C12-11-006

Scientific Rating: A
Recommendation: C1 Conditionally Approved

between the measured rates and the simulations. Although there is still a substantial amount of work needed to get from this first test run to a full operation of the experiment, the view from the PAC is that the experiment should be promoted to the next level: Conditional Approval 1, which does not require a return to the PAC, but leaves it to the laboratory management to conduct a technical review of the experiment and to schedule beam

April 2014

Dear John and Stepan,

Thank you for submitting the document we requested regarding your response to the July 2013 DOE review of HPS and updating your run plans. We have studied your document and are generally pleased with the efforts you are making to address the comments from the review panel. The full rate test of electronics and DAC is still to come, but we would like to involve personnel from the JLab experimental physics division to review and monitor your progress in this area. Rolf and Volker will be in contact with you about this.

Nevertheless, we agree that HPS has sufficiently satisfied the requirements to remove the C1 conditional approval. With the concurrence of the Lab Director, Hugh Montgomery, (see below) we will grant HPS full approval for the engineering run currently envisioned for FY15. Approval for future running beyond this engineering run will be contingent on successful demonstrated performance of the HPS apparatus during the engineering run.

We look forward to working with you to successfully realize the potential of the HPS experiment.
Best regards,
Bob

2015-2016

Engineering runs at 1.1 GeV and 2.3 GeV (used only 15 PAC days)

July 2016

Fully Approved for full 180 PAC days (165 PAC days remains to run)

June 2019

Run I – 31.5 PAC days

?? 202*

Run II

?? *

Run Run Run



OFFICE OF
SCIENCE

S. Stepanyan, HPS Review, SLAC
January 18, 2019

Jefferson Lab
Thomas Jefferson National Accelerator Facility



What has been achieved since the first proposal

- HPS has been presented to JLAB PAC, first PAC37 in 2011 (C2) and then PAC39 in 2012(C1)
- Successfully passed two DOE reviews for funding, March 2011 (got funding for the test apparatus) and in July 2013 (has been fully funded for detector construction)
- Built a test setup and run with photon beam in 2012, proved detector technologies and confirmed our estimates of occupancies dominated by multiple scattering
- Built the full apparatus in 2013-2014, completed JLAB readiness reviews in 2014 (ERR and ARR) and has been approved for engineering runs
- Successfully completed two engineering runs, in 2015/2016 with 1.05/2.3 GeV beams
- HPS was fully approved by JLAB in 2016 with requested 180 days of beam time, 39 of which was given “High Impact” status by JLAB PAC-41
- In June of 2017 HPS upgrades passed ERR as part of preparations for 2019 run
- Published one physics paper, Phys.Rev. **D98**, 091101(R), and conference proceedings (ICHEP) arXiv:1812.02169 [hep-ex] and three technical papers:
 - “*The Heavy Photon Search test detector*”, NIM **A777** (2015) – based on the 2012 test run with photon beam
 - “*The HPS Electromagnetic Calorimeter*”, NIM **A854** (2017) – based on the engineering runs
 - “*The Heavy Photon Search beamline and its performance*”, NIM **A859** (2017) – based on the engineering runs
- Working towards for more publications from the engineering runs, resonance (2016) and displaced vertex (2015/16) search results.

First physics publication

- Resonance search results from 2015 run has been published as Rapid Communication in Physical Review D **98**, 091101(R)
 - article was posted on arXiv 7/30/2018
- Article has been selected to be a PRD Editors' Suggestion and has been featured on the Physical Review D homepage

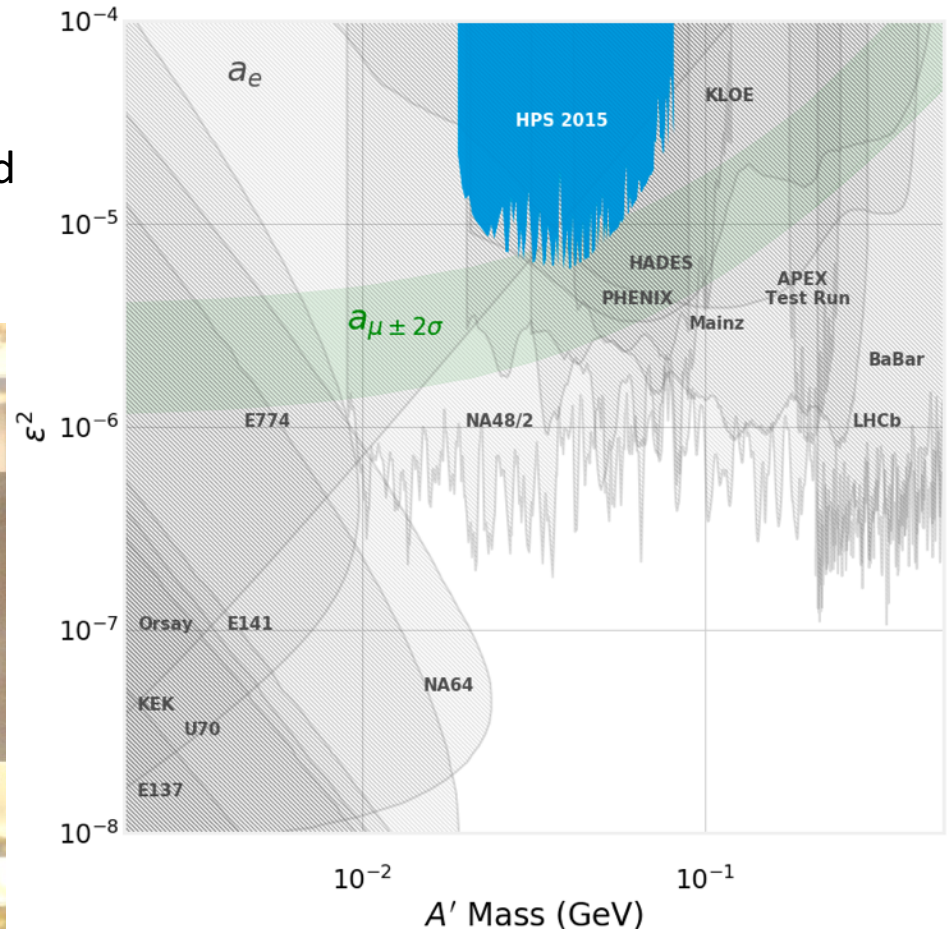
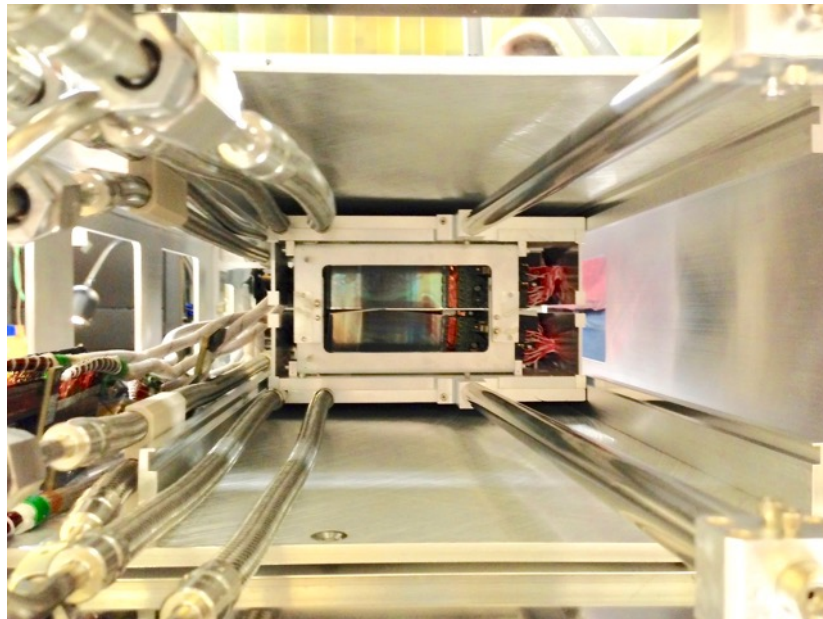

Progress in displaced vertex search

- Omar and Matt S. presented resonance and displaced vertex search results from 2015 run at ICHEP, 4-11 July 2018, Seoul, South Korea.
- A search for displaced A' decays did not rule out any territory but resulted in a reliable analysis procedure that will probe new, unexplored parameter space with future, higher luminosity runs.

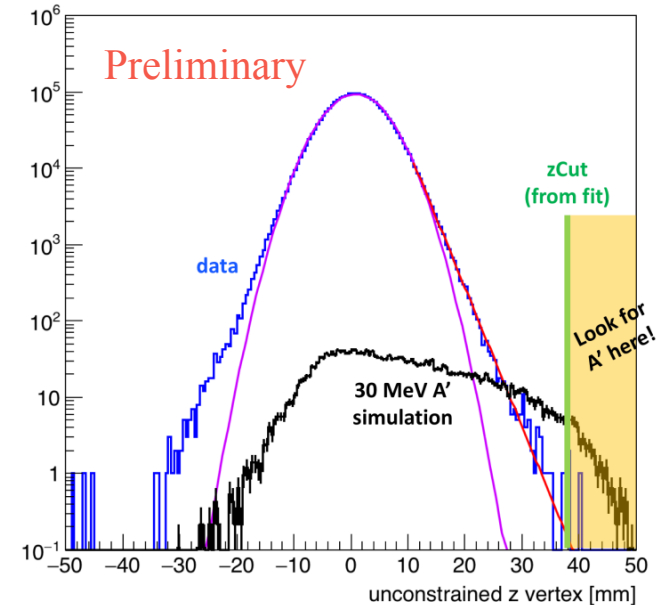

Maximum detectable A' after z-cut with 2015 integrated luminosity, 1165 nb^{-1}
 The 90% confidence limit for zero background requires greater than 2.3 A' events

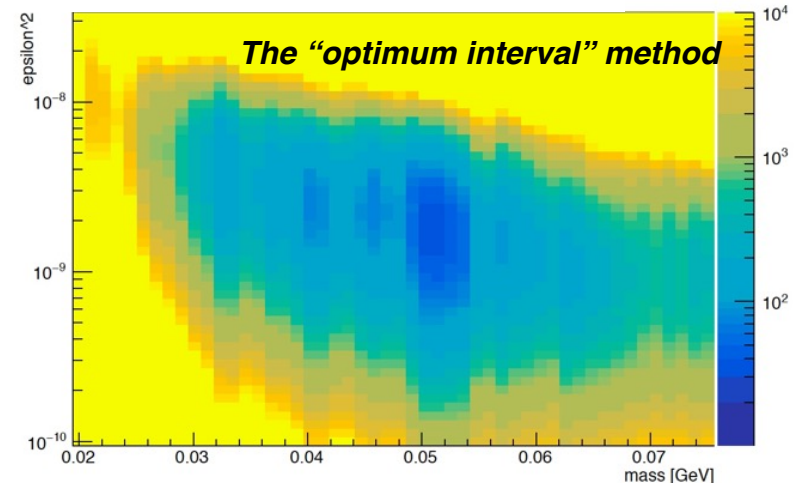
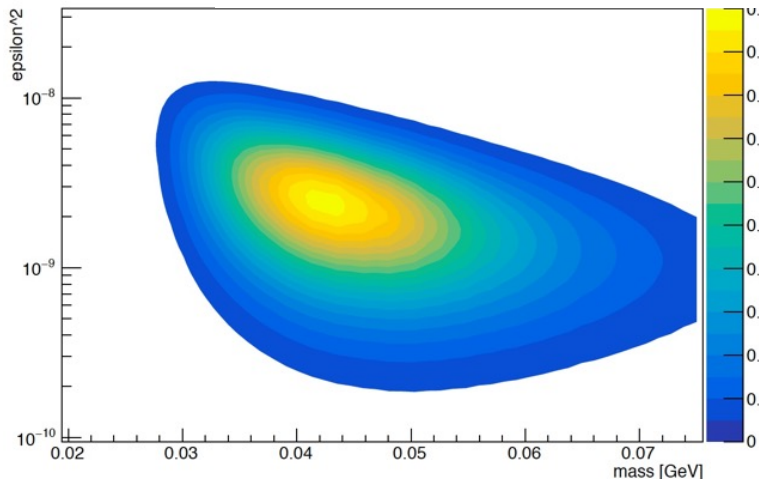

More on analysis in Nathan Baltzell's talk

Reach was lower than expected in the Engineering Run, but will be reclaimed with an upgraded detector

- We overestimated the vertex reach of the engineering run detector:
 1. Electron hole in the ECal was not taken into account resulting to **x2** higher detection efficiency for pairs
 2. Acceptance vs. decay length was assumed to be the same as for prompt decays, that overestimated integrated rate for long-lived A' by **x2**
 3. The original MC was giving **x1.5** higher yield due to incorrect nuclear form-factor
 These amounted to a total loss in pairs rates in data compared to the earlier estimate – **x6**
- With proposed detector/trigger upgrades, original reach will be restored:
 1. A single-arm positron trigger will eliminate losses due to the ECal electron hole. Such trigger requires a scintillation hodoscope in front of ECal to tag positrons and veto bremsstrahlung photons that scatter to the positron side of the calorimeter. The overall gain in pairs rate detected in the tracking is expected to be **x2**
 2. The SVT Upgrade:
 - Adding one more layer of sensors 5 cm downstream of the target, L0, will improve vertex resolution by about factor two, increasing integrated detection efficiency for long-lived particles by **x2+** and
 - Moving L2 and L3 closer to beam will boost acceptance for long-lived A' by another **x 1.5**
- These upgrades, together with longer running, 4 PAC weeks, will regain most of the original HPS reach for displaced vertex search.

First production run

- HPS is scheduled to run for 63 days (31.75 PAC days) in summer of 2019, June 10 to August 11
- Beam energy for HPS at 5th pass is expected to be 4.55 GeV, beam bunch frequency 499 MHz
- HPS will be ready with upgraded detector: SVT with LO, scintillation hodoscope and a new single-arm trigger – the upgrades are necessary to reclaim originally proposed reach
- HPS may face some challenges for smooth running. A parity experiment in Hall-A will run in parallel to HPS in Hall-B. Parity experiments have very stringent requirements for the beam quality and polarization, and require very high current beams (70 μ A)
- The CLAS12 spring run ends on April 7. Hall-B will be ready for HPS installation starting the week of April 15 – must remove some of the CLAS12 detectors and beam pipes before HPS can go in.

SVT Upgrade

- A new silicon layer, Layer 0, thinner and closer to the target improves vertex resolution $\sim 2x$
- More technically aggressive than current SVT: special sensor processing
- It is possible and advantageous to replace current Layer 1 with new Layer 0 modules:
 - less dead material to convert WABs
 - active area can be closer to beam, improving angular acceptance for long-lived signal events
 - enables lower occupancies and improved pattern recognition
- Further improvement in efficiency for displaced vertex analysis will be achieved by moving Layer 2 and Layer 3 closer to the beam plane.

Details in Tim Nelson's talk

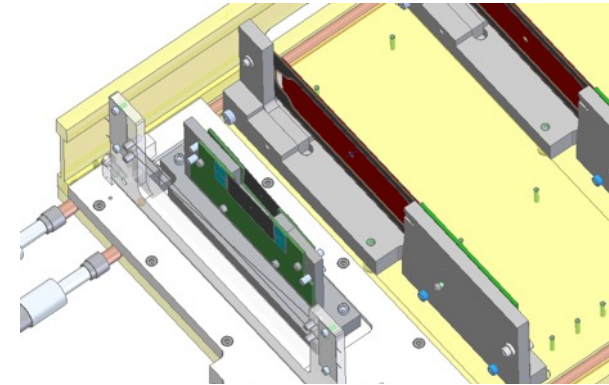

Vertex Resolution Ratio Nominal/L0

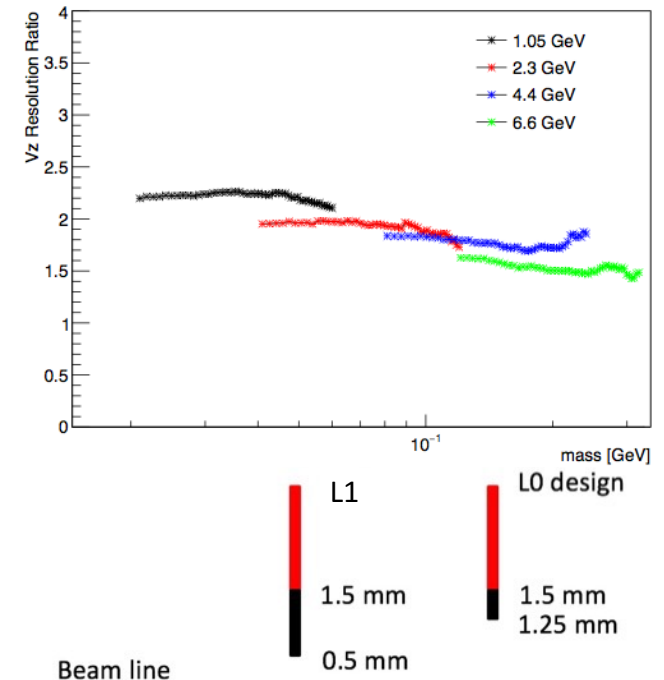

Important change for suppressing scatters

Trigger upgrade – scintillation hodoscope

- Cluster pair trigger worked well, efficiency >95%, DAQ rates ~ 20 kHz at $LT \approx 95\%$
- But, more than $\frac{1}{2}$ of the recorded triggers were from $(e^- \gamma)$ pairs and the half of the $(e^+ e^-)$ pairs where e^- scatters in the ECal electron hole were lost in the trigger, although they could have been reconstructed by the tracking system
- A single arm positron trigger will resolve both issues

Scintillation counter on the “positron” side to veto photons in the trigger

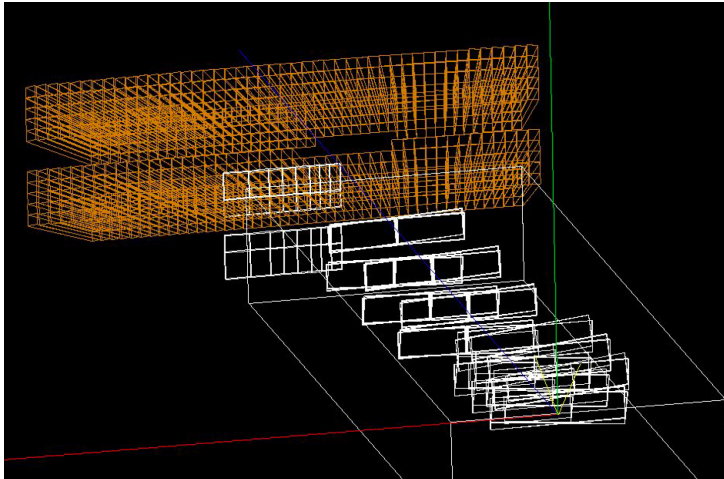

Scintillation hodoscope: double layer of scintillator strips for each half, with WLS fibers and maPMT readout

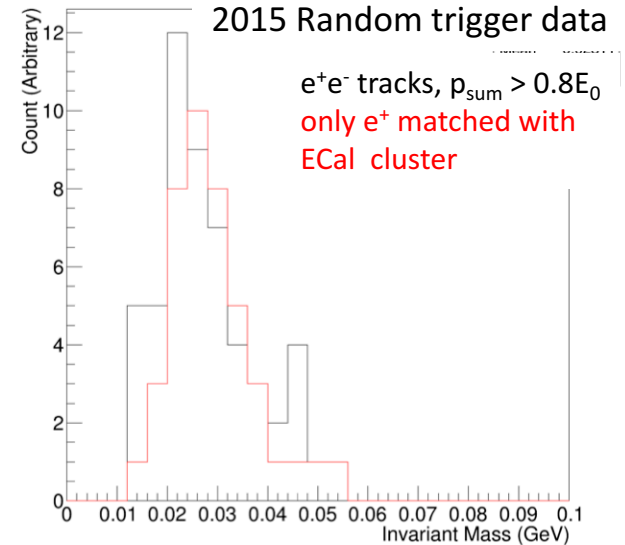
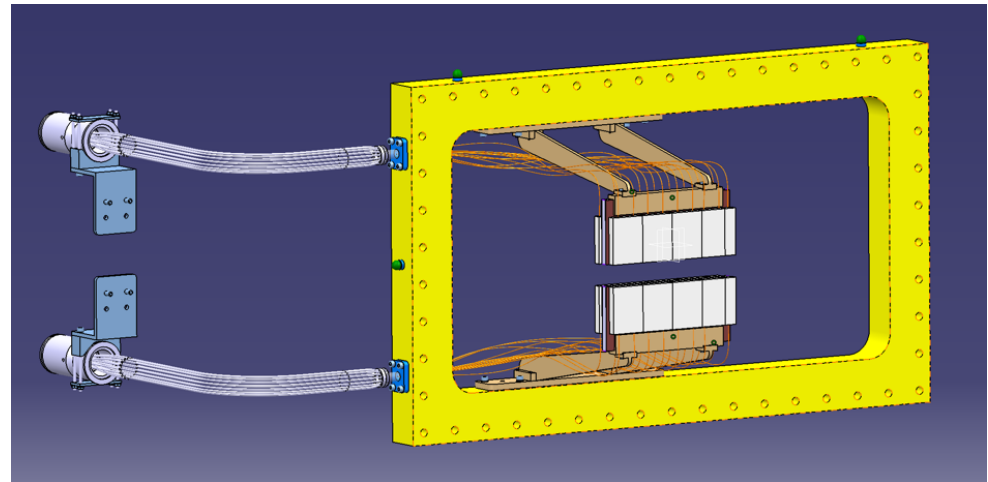

Details in Rafayel Paremuzyan's talk

S. Stepanyan, HPS Review, SLAC
January 18, 2019

2019 beamline configuration for HPS

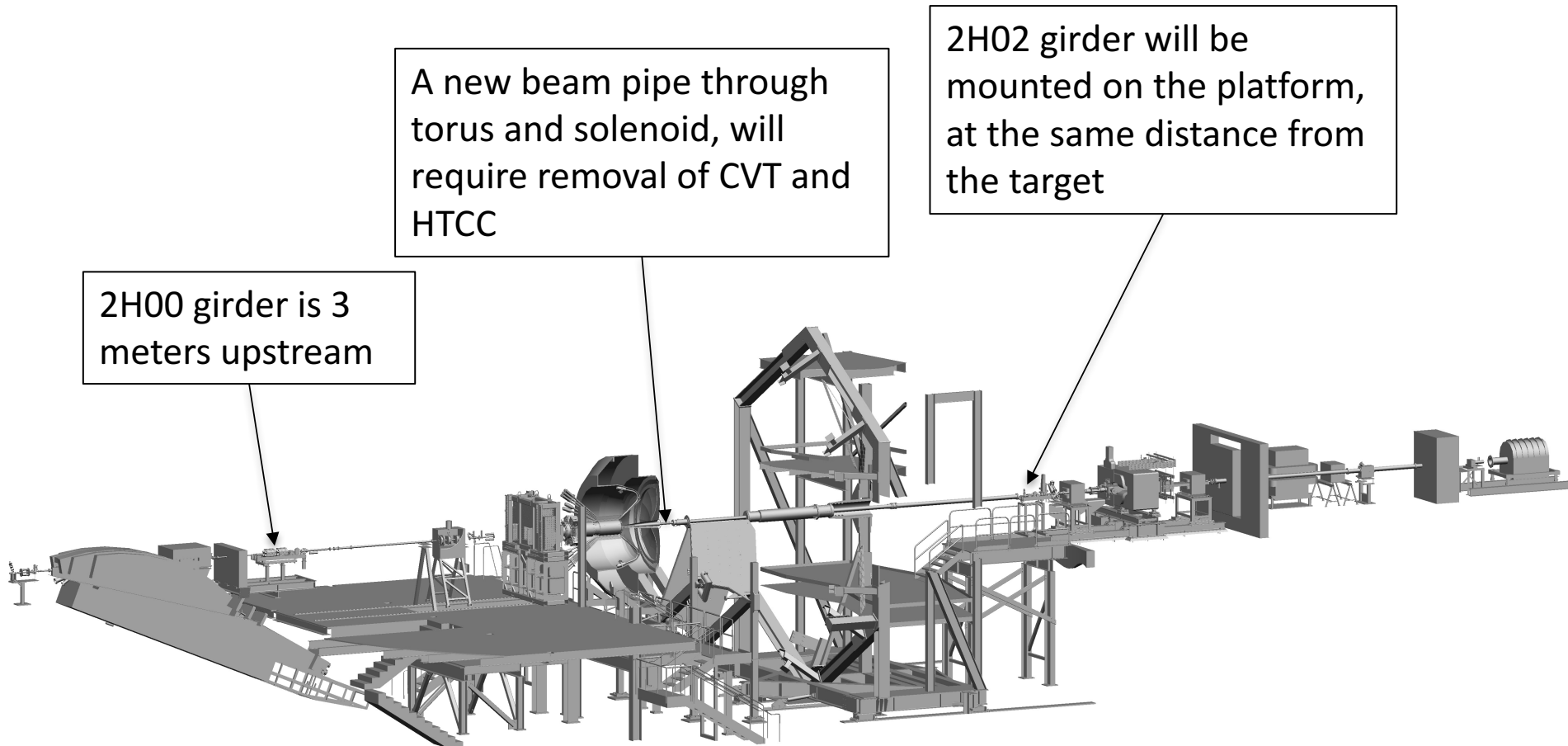

HPS installation

- During the CLAS12 operations, HPS was disconnected and moved off the beam line
- Installation is being planned in detail, there are dependences in the sequence of detector installation. Staged approach may be needed, depending on the progress of upgrades
- With everything ready, the whole installation is a ~ 2 weeks effort
- Couple of weeks will be devoted to run and debug DAQ/trigger and calibrate Ecal after everything is in place

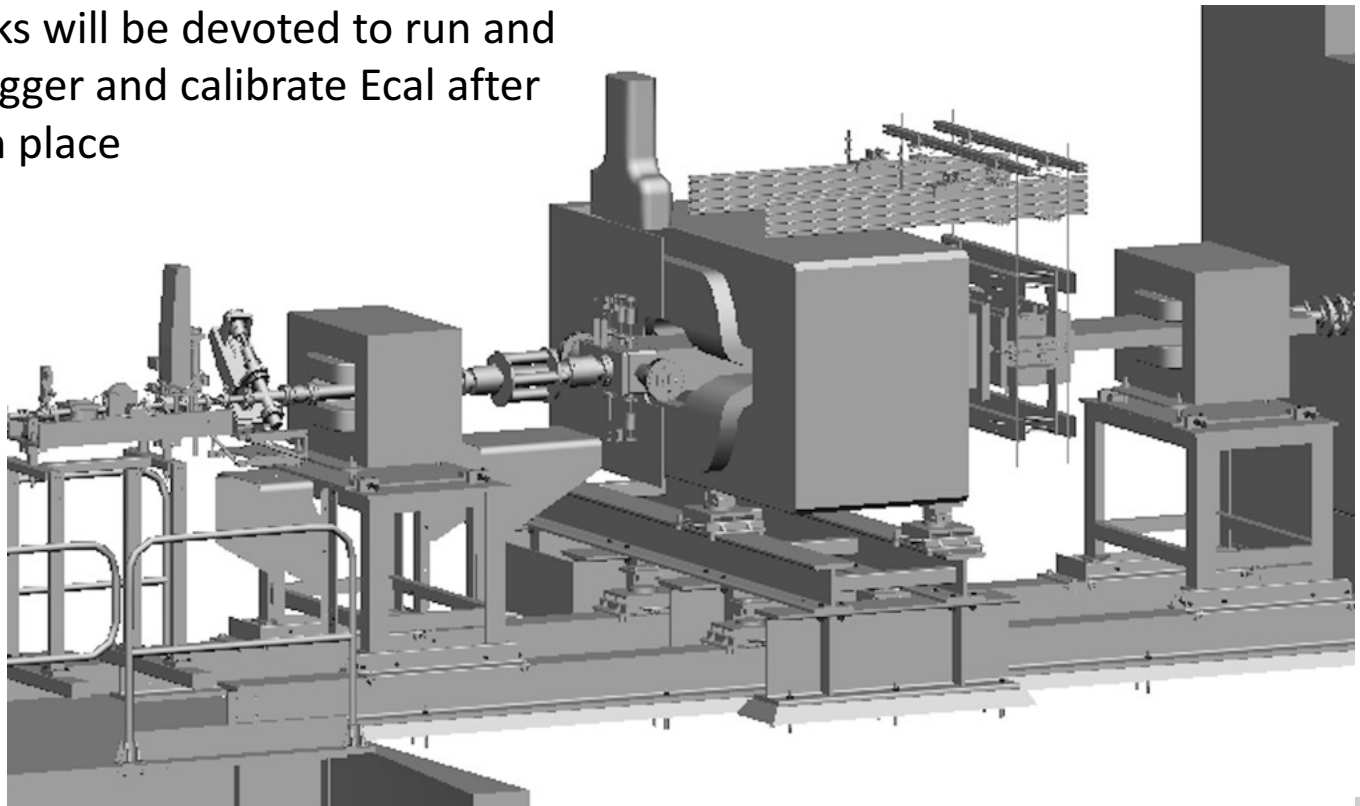

Beam profile and position stability

Profile of 5-pass, 10.7 GeV beam at 2H01A harp, 7 m upstream of the CLAS12 target

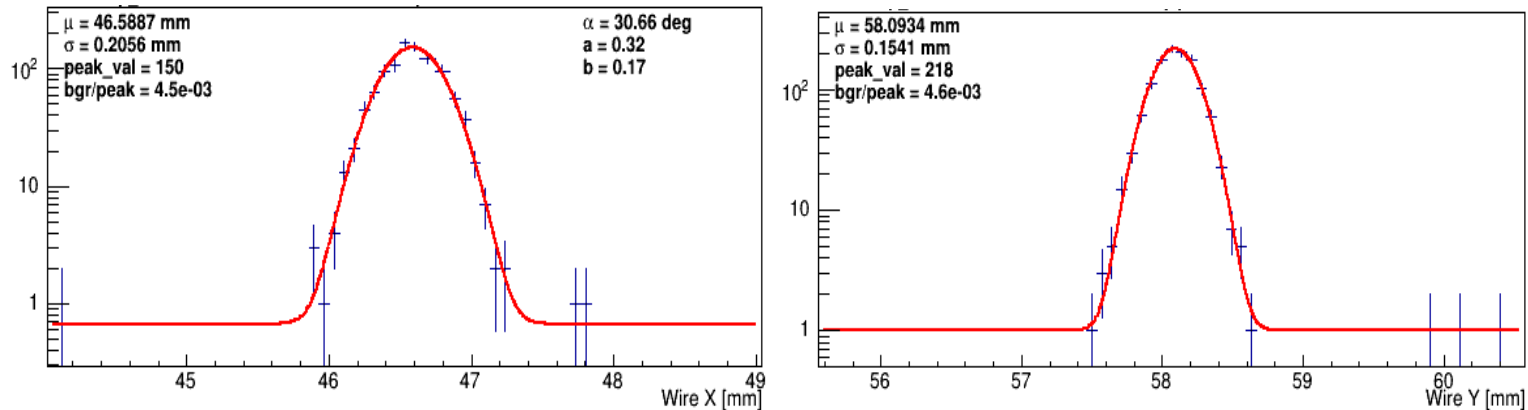

Beam position stability at 2H00 BPM with $I_B \approx 50$ nA (Feb. 2-28)

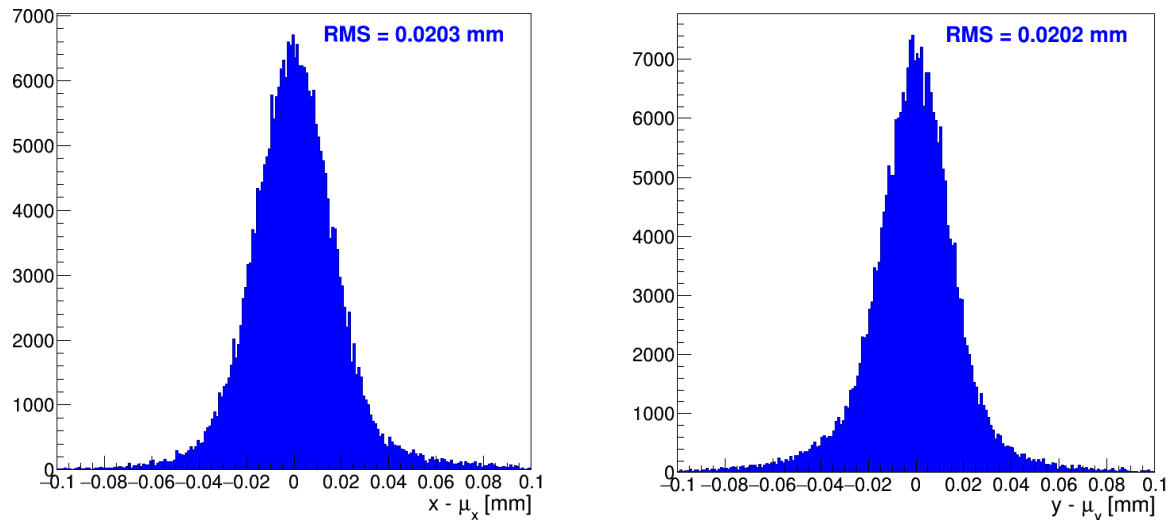

HPS SVT sensor is at 0.5 mm from the beam plane

Parameter space for Heavy Photon Search

- Since the first proposal, available parameter space for A' searches has changed significantly. Precision measurements on colliders, and with hadron and electron machines, cover excluded wide range of masses for $\varepsilon^2 > 10^{-6}$
- Theoretical predictions for hidden sector photons have sharpened. Some of original motivations disappeared, e.g. muon $g-2$, and new targets have emerged

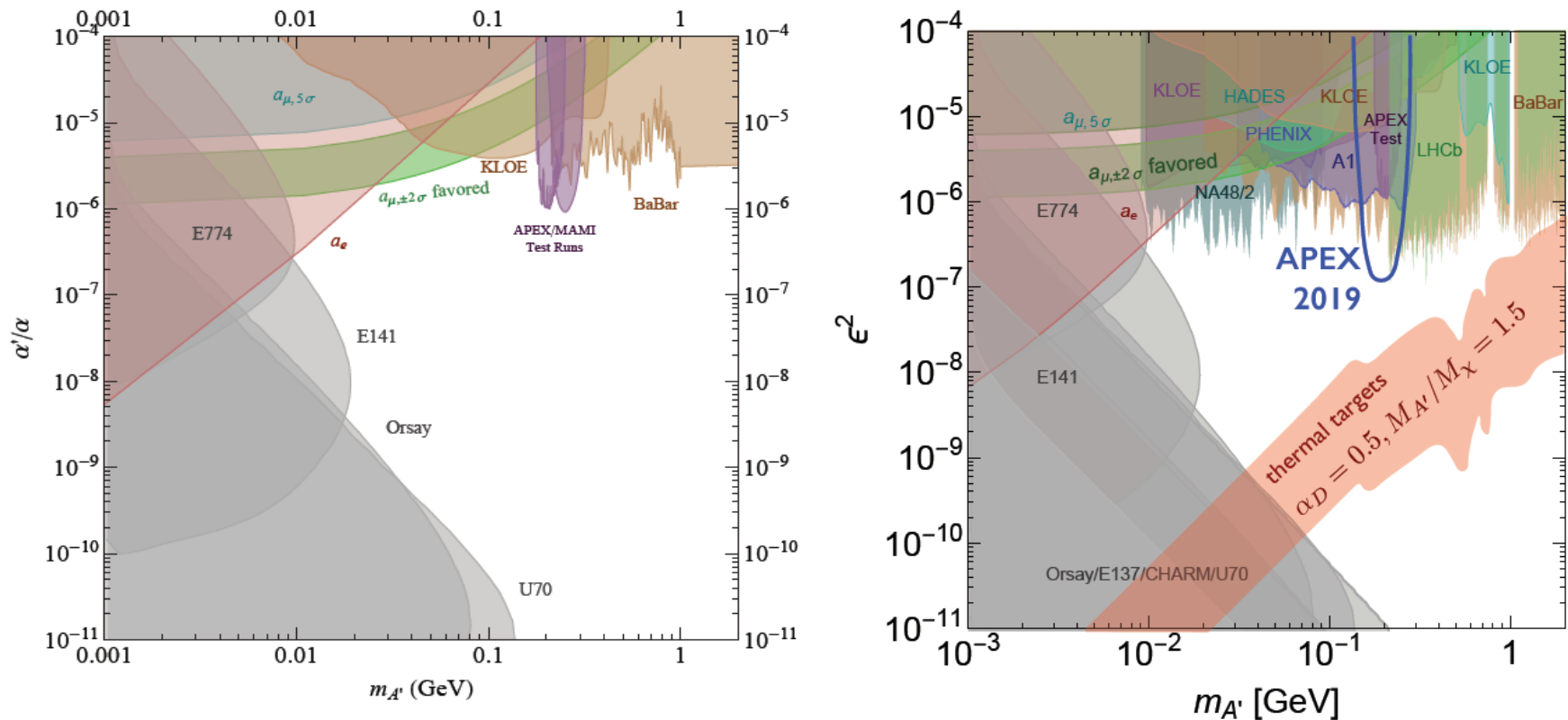

Competition from future experiments

- LHCb claims coverage in HPS territory in Run III (2021-2023) with trigger-less readout
- SeaQuest coverage with proposed Ecal trigger overlaps with HPS territory
- New proposals at CERN (FASER, SHIP, NA62) are under consideration, and Belle II will push limits down at large ε by another order of magnitude

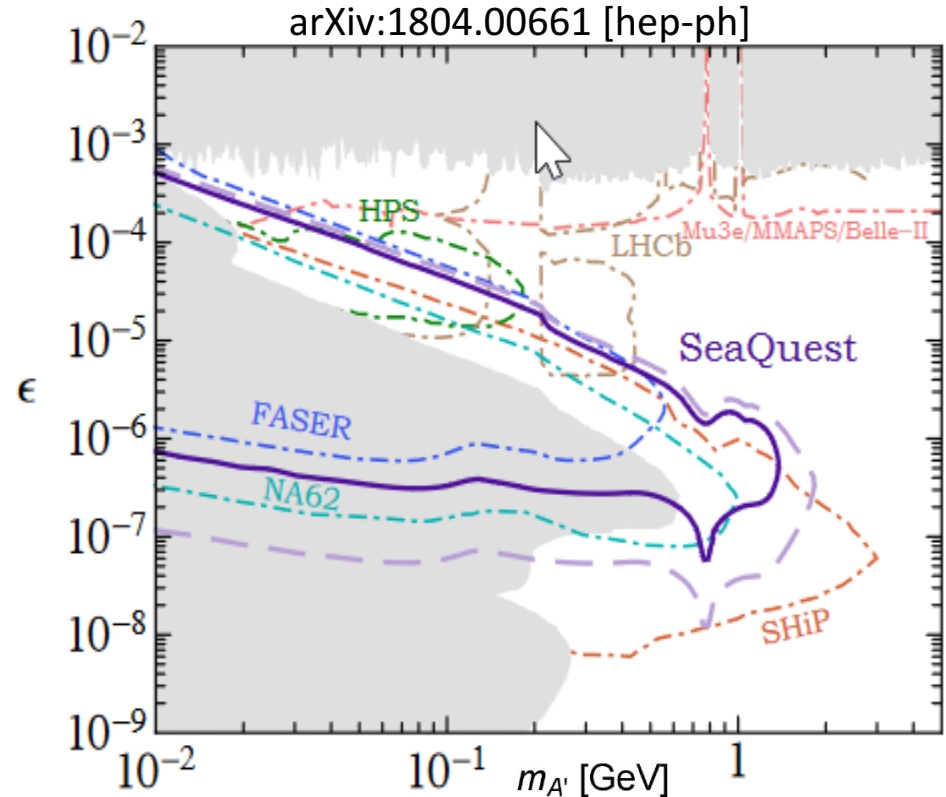
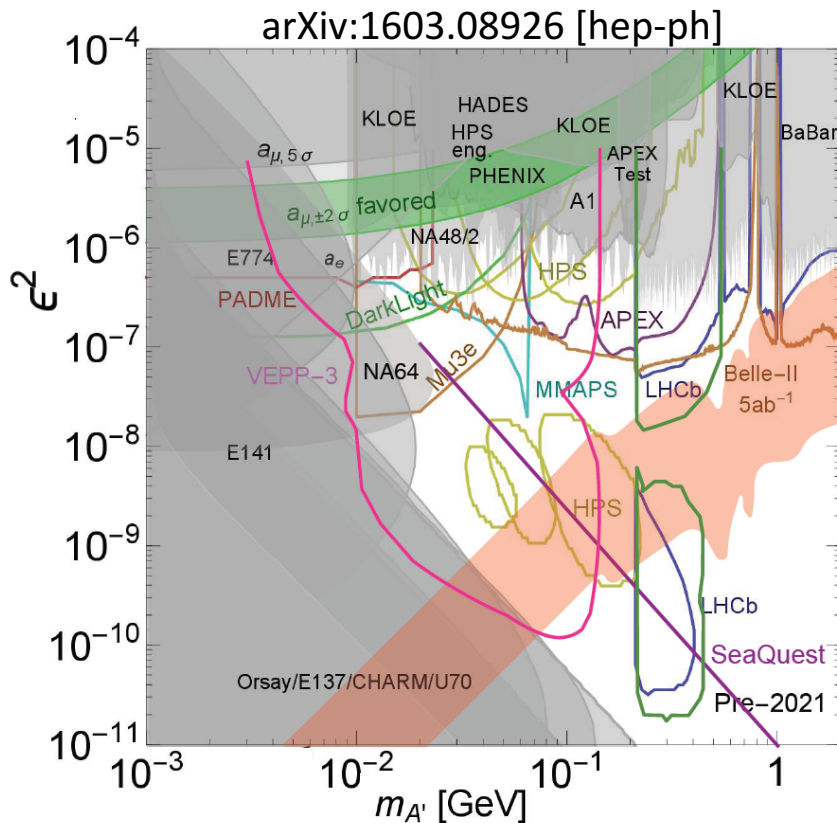

HPS 2019

- HPS has a unique reach in the region of parameter space well motivated by Light Thermal Dark Matter models
- Using displaced vertex search, HPS will cover uncharted region of A' masses from 80 MeV to 200 MeV and the couplings as low as few $\times 10^{-10}$ with upcoming run in 2019 at 4.5 GeV
- While the main target is the heavy photon, experiment is sensitive to any new physics that makes long lived states and uniquely positioned to go after other targets such as SIMPs and True Muonium.

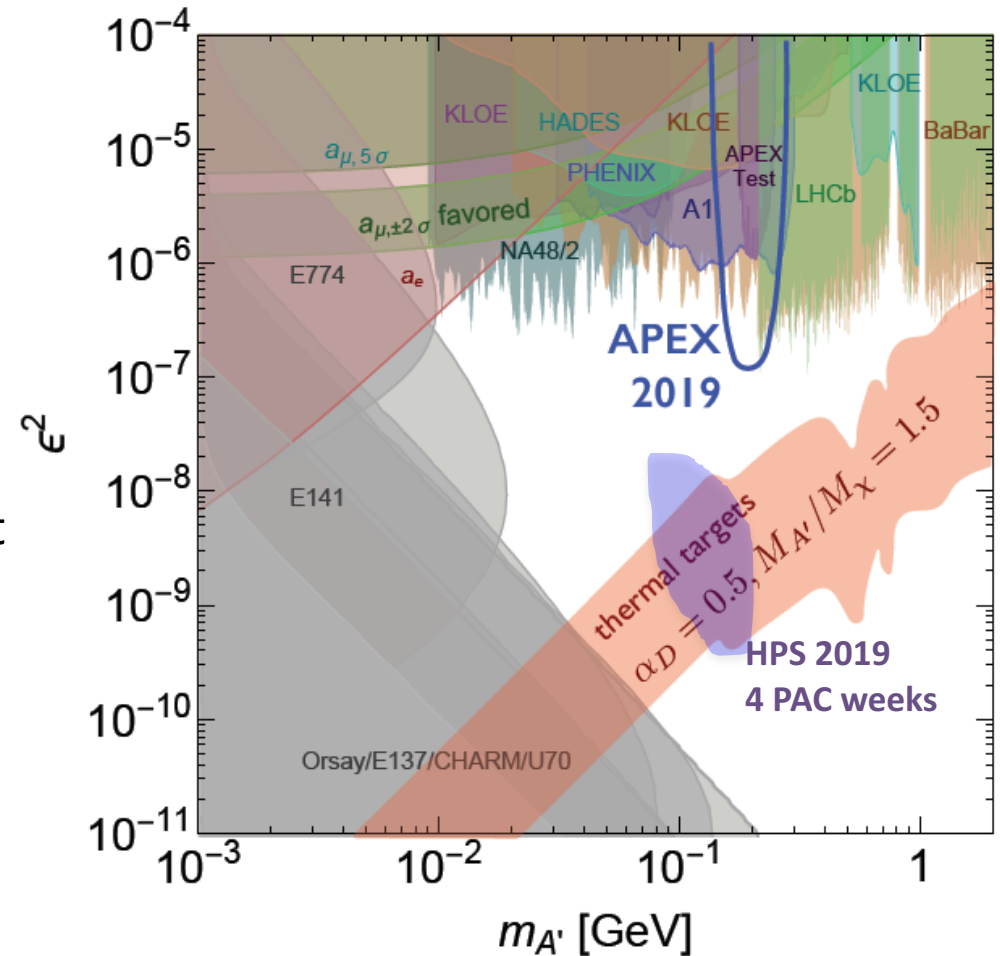

Jeopardy process and future running

- The process of Jeopardy will begin with PAC meeting in 2019, first with proposals in Halls A and C approved in 2006-2007 that have not been (fully) run or scheduled
- In 2020, the Jeopardy process will be applied to the presently approved Hall B program. Each run group that has not been scheduled to **complete** yet (in 2020) will be considered for Jeopardy. Proposals that remain approved after consideration at this meeting will be granted 4 more years to be scheduled.
- Hall B jeopardy might include the current Run Groups A, B, C, D, E, G, H, I (note: HPS is the Run Group I), but of course it depends on the actual run schedule in the next 5 years
- It is likely that HPS will have to go in front of the PAC in 2020 to defend remaining approved beam time, ~134 days! We have clear plans for the remaining beam time. As was originally proposed, with longer running (6 - 7 weeks) at ~2 GeV and 6 GeV HPS will extend the search in significant portion of highly motivated region of parameter space
- These two energies will use ~70% of the remaining beam time, use of the remaining 30% will depend on the status of the field at that time
- In the region of masses $m_{A'} > 2m_{\mu}$ accessible at high energies, HPS will benefit from having a muon detector, descoped from the original detector.

Summary

- Last decade was quite fruitful for MeV-GeV Dark photon searches. Nevertheless large parameter space in mass and coupling remains unexplored. HPS experiment at Jefferson lab with its unique experimental capabilities is ready make sizable contribution to these searches
- HPS had a long journey since the first proposal – built detectors, run successfully engineering runs, made a significant progress in understanding the backgrounds, developed analysis technics and built a realistic MC
- First physics paper on resonance search was published from analysis of 2015 engineering run data. While analysis of displaced vertex search did not rule out any territory, it resulted a reliable analysis procedure. More results are expected from analysis of 2016 data
- Currently, the highest priority for HPS are the completion of the upgrades and preparations for the first production running in Summer of 2019
- HPS is also preparing for more beam time request. Extended runs at low (~ 2 GeV) and high (~ 6 GeV) energies will explore significant part of well motivated parameter space

Backups



S. Stepanyan, HPS Review, SLAC January 18, 2019

