



**Mail Addresses:**

**Headquarter**

**RoentDek** Handels GmbH  
Im Vogelshaag 8  
D-65779 Kelkheim-Ruppertshain  
Germany

**Frankfurt branch**

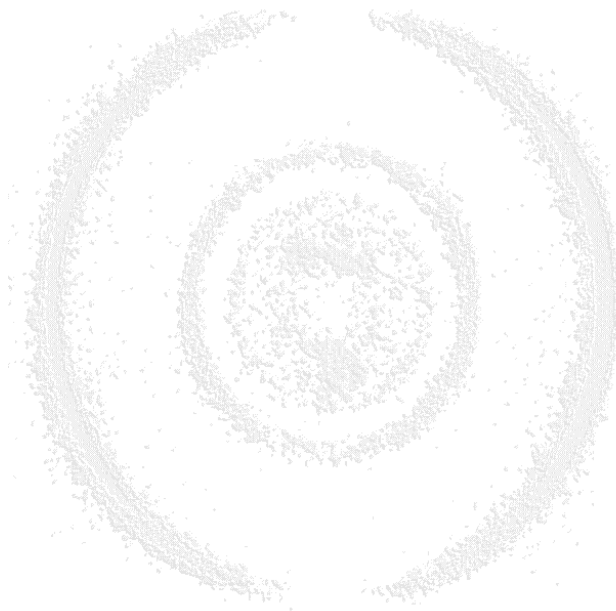
**RoentDek** Handels GmbH  
c/o Institut für Kernphysik  
Max-von-Laue-Str. 1  
D-60438 Frankfurt am Main  
Germany

**Web-Site:**

[www.roentdek.com](http://www.roentdek.com)

**WEEE:**

DE48573152



Product names used in this publication are for identification purposes only and may be trademarks of their respective companies.

All rights reserved. Technical changes may be made without prior notice. The figures are not binding.

We make no representations or warranties with respect to the accuracy or completeness of the contents of this publication.

## Table of Contents

<b>DETECTOR SYSTEM - COMPONENTS.....</b>	<b>5</b>
<b>1 THE MICROCHANNEL PLATE DETECTOR WITH DELAY-LINE ANODE.....</b>	<b>7</b>
1.1 GENERAL DESCRIPTION.....	8
1.1.1 Position Encoding.....	8
1.1.2 Timing information:.....	10
1.2 ASSEMBLY OF THE MCP-DETECTOR.....	11
1.2.1 List of Detector Assembly Parts.....	11
1.2.2 Preparation.....	11
1.2.3 Connecting the Wires to the Delay-line Anode.....	12
1.2.4 Assembly of the MCP-stack.....	14
1.2.4.1 Assembly of the MCP-stack for the DLD40, DLD80 and HEX80.....	14
1.2.4.2 Assembly of the MCP-stack for the DLD120 and HEX120.....	18
<b>2 MOUNTING OF THE DETECTOR AND CABLE CONNECTIONS VIA VACUUM FEEDTHROUGH....</b>	<b>23</b>
2.1 MOUNTING OF THE DETECTOR ON A VACUUM-FLANGE.....	23
2.2 CONNECTING THE SIGNAL CABLES TO A FEEDTROUGH FLANGE.....	25
2.3 THE FT12TP (HEX) – FEEDTHROUGH FLANGE WITH SIGNAL DECOUPLER.....	26
2.4 THE FT4(TP) FOR FT16(TP) AND DET40/75.....	29
2.5 OPERATION OF THE MCP DETECTOR WITH DELAY-LINE (OR TIMING) ANODE.....	30
2.5.1 Initial Startup Procedure.....	30
2.5.2 General Operation.....	32
<b>3 THE FRONT-END TIMING ELECTRONICS MODULES: AMPLIFIER &amp; CFD MODULE.....</b>	<b>35</b>
3.1 SIGNAL INPUTS AND AMPLIFICATION.....	36
3.2 THE DLATR BOARD.....	38
3.3 CFD CONTROLS AND OUTPUTS.....	38
3.4 CONNECTING AND OPERATING THE ATR19.....	40
3.5 OPENING THE ATR19 MODULE.....	41
3.6 THE ATR19-2(B) MODULE.....	42
3.7 FINAL ADJUSTMENT FOR DETECTOR OPERATION.....	43
3.8 THE SPS1(B) MAINS ADAPTER.....	46
3.8.1 Connecting the SPS1.....	46
3.8.2 How to switch the AC supply voltage.....	47
3.8.3 Output voltage adjustment.....	48
3.8.4 Maintenance and Troubleshooting.....	48
3.8.5 Technical Specifications.....	49
3.9 TROUBLESHOOTING THE ATR19'S INTERNAL MAINS POWER SUPPLY.....	49
<b>4 DATA ACQUISITION HARD- AND SOFTWARE.....</b>	<b>53</b>
4.1 THE TIME-TO-DIGITAL-CONVERTERS (TDC) FOR PC.....	53
4.1.1 TDC8HP.....	53
4.1.2 The HM1 / HM1-B.....	54
4.1.3 The TDC8.....	55
4.2 HARD- AND SOFTWARE INSTALLATION.....	55
4.2.1 TDC8HP.....	55
4.2.2 HM1 / HM1-B.....	56
4.2.3 TDC8.....	57
4.3 CONNECTING THE ATR19 OR CFD WITH THE TDC.....	57
4.3.1 TDC8HP (or TDC8).....	58
4.3.2 HM1 / HM1-B.....	58
4.4 STARTING THE COBOLDPC 2011 R3 SOFTWARE:.....	58
4.4.1 Hardware specific commands: DAq-parameters and coordinates.....	61
4.4.2 Analysis specific commands: DAN parameters and coordinates.....	62
4.4.3 Spectra and condition definition commands.....	65
<b>5 HIGH VOLTAGE SUPPLIES.....</b>	<b>69</b>

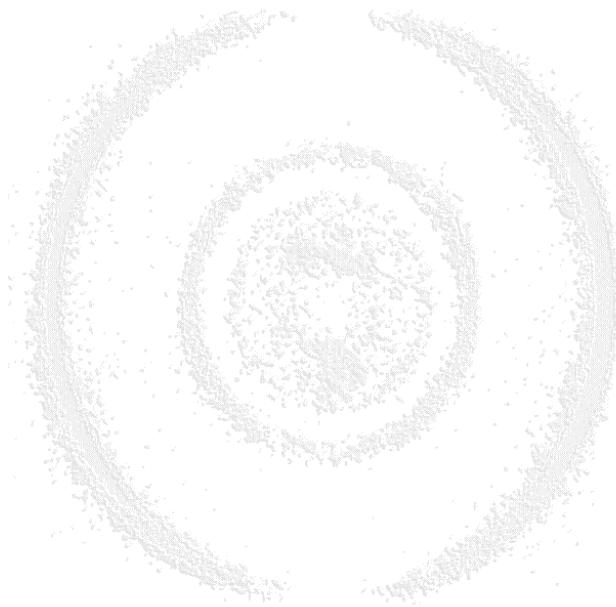
5.1 THE HV 2/4 DUAL HIGH VOLTAGE SUPPLY MODULE ..... 69  
5.2 THE BIASET3 WITH SPS2(MINI)..... 71  
5.3 BA3 BATTERY UNIT ..... 73  
5.4 HVT AND HVT4 HIGH VOLTAGE TERMINATORS ..... 74  
5.5 HVZ VOLTAGE DIVIDER UNIT ..... 75

**APPENDIX: (MCP'S): ..... 79**

**LIST OF FIGURES ..... 81**

**LIST OF TABLES ..... 83**

**LIST OF EQUATIONS ..... 83**



## Detector System - Components

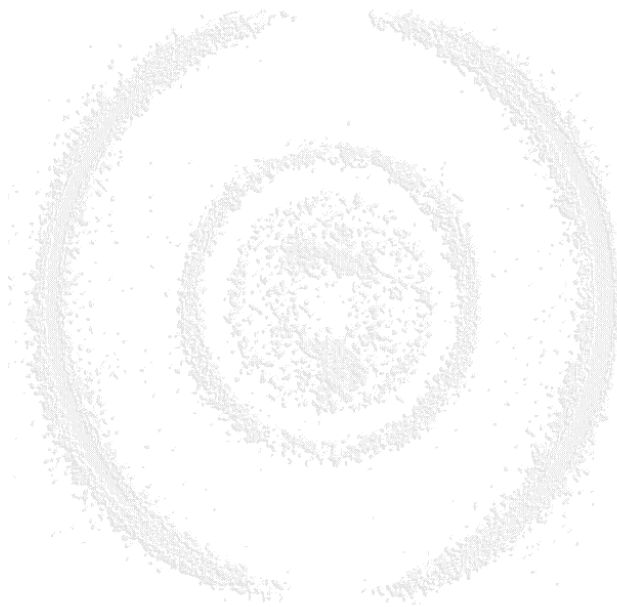
This manual describes all major components of the **RoentDek** delay-line detector system as it can be delivered for the **DLD40(EP)**, **DLD80(75eT)**, **HEX80/HEX75** and **DLD120** and **HEX120(100)** detector. Even if you have not purchased the complete system you will find valuable information in the chapters describing the different components about the link between the components and the operation. However, you might have received only the relevant parts of this manual.

1. **DLD** or **HEX** microchannel plate detector with delay-line anode
  0. **FT12(16)TP** 12-pin CF35 (and fourfold MHV) UHV-feedthrough flange(s) with signal decouplers and (optional) flange mounting gear on DNxxxCF flange with CF35 ports (xxx = 100 – 300)
  0. **ATR19** fast (differential) amplifier unit with integrated constant-fraction-discriminator (default) or **FAMP8** (or similar) amplifier unit, **CFD8c/7x**: (or similar) constant-fraction-discriminator modules (for download)
  0. **TDC8HP** or **HM1** time to digital converter and **CoboldPC** read-out software (default) or **fADC4/8** fast ADC units (for download)
- Error! Reference source not found.. **HV2/4**, **BIASET3** or similar high voltage supply assembly and **BA3/HVT/HVZ** auxiliary bias units.

Please follow the link <http://www.roentdek.com/manuals> for device specific manuals.

If you have received special detector components, i.e. a detector of different size or type, or other electronic modules you will find a separate manual commenting on peculiarities of your special system. In this case the information given here is mostly relevant for your system but you might need extra information. Please also refer to the FAQ document on the web page.

Please always check our web site for updates after you have received our products or contact **RoentDek**.



## 1 The Microchannel Plate Detector with delay-line anode

The **Micro-Channel Plate** detector with delay-line anode is a device for single particle/photon counting, giving information on the position of each particle/photon and its impact time with high precision. It uses an electronic read-out scheme employing fast timing amplifiers, timing discriminators and digitizers. It operates under ultra-high vacuum and requires high voltage supplies.

This detector system is modular and com in different sizes and versions.

### Typical performance:

position resolution	< 0.1mm
overall linearity	0.3mm
rate capability	1MHz
multi-hit dead time	10-20ns

### Typical characteristics of MCPs (for DLD40EP, DLD75eT and HEX75 see below)

# of MCPs in stack	2
Outer Diameter:	50/86.6/127mm
Active Diameter:	45/80/120mm
Aspect Ratio L/D	60:1
Thickness	1.5mm
Pore size	25µm
Center-to-center spacing:	32µm
Bias Angle:	8° ± 1°
Open Area Ratio:	>50%

for **DLD40EP** MCP: 40mm OD (>40mm active), L/D 80:1, 1mm thickness, 13µm pore size, bias angle: 20°, OAR > 70%

for **DLD75eT** MCP: 86.7mm OD (75mm active), L/D 80:1; 1mm thickness, 13µm pore size, bias angle: 19°, OAR 64%

for **HEX75** MCP: 86.7mm OD (75mm active), L/D 40:1; 1mm thickness, 26µm pore size, bias angle: 20°, OAR 70%

The **HEX75** uses triple MCP stacks (Z-stacks). Other detectors can also be delivered with triple MCP stacks (option **.../Z**)

The **HEX120** can also be delivered as **HEX100** with 114mm OD MCP (105mm active), 26µm pore size, bias angle: 20°, OAR 70%

### Typical characteristics of the detector assembly

Height above a mounting Flange:	about 100mm (adjustable)
Mounting Diameter:	94/144/196/246mm
Operating Temperature Range:	-50 to 70°C
Operating Pressure:	< 2 x 10 <sup>-6</sup> mbar
Baking Temperature:	150°C Maximum
Electron Gain @ 2400Volts*:	10 <sup>7</sup> Minimum

If you have chosen a detector set with central hole, its size in the MCP is usually 6.4mm and the minimum active diameter 9mm.

If you have chosen a different custom detector type, e.g. **DLD25**, **DLD80x100**, **DLD100**, **DLD150**, or **HEX40** please refer to the separate instructions.

---

\* For **DLD40EP**, **DLD75eT** or **/Z** options: about 300V higher voltages may be applied.



## 1.1 General Description

The **RoentDek** MCP detector with delay-line anode is a high resolution 2D-imaging and timing device for charged particle or photon detection at high rates with limited multi-hit capability. The linear active diameter is at least 40mm for the detectors with the **DL40** anode (e.g. **DLD40** and **DLD40EP**), 75mm for the **DL80** anode (e.g. **DLD80** and **DLD75eT**), and about 120mm for the **DLD120**. The **RoentDek Hexanode** has a third delay-line layer that gives redundant detection opportunities either to improve the multi-hit performance, linearity or to allow the use of a MCP setup with central hole and minimized blind detection area. In its usual version (**HEX80**) it has about 75mm redundant detection area (**HEX120**: 100mm redundant, up to 115mm linear with at least two layers, total up to 120mm, **HEX100**: 100mm redundant detection area, **HEX40** about 40mm redundant detection area)\*. For detectors with central hole (e.g. **HEX40/o** and **HEX80/o**) the descriptions in this manual are also relevant unless otherwise stated. A **DLD150** version is available on demand with 150mm active detection diameter.

The detector consists of a pair of selected MCPs in chevron configuration or of a triple stack (Z-stack) and a helical wire delay-line anode for two-dimensional position readout. The MCPs are either supported by a pair of partially metalized ceramic rings (1.5/2mm thick, 65/105mm outer diameter for **DLD40/DLD80** and **HEX80** with metal contacts on the ceramic rings are suitable for soldering, clamping or spot welding) or the MCP stack is mounted between a metal front ring and a (usually square-shaped) rear side holder plate, e.g. for the **DLD120** and **HEX120(100)** or custom MCP stack designs.

Operation requires two DC voltages for a (resistance matched) MCP stack on front and back contacts and three voltages for the anode's support plate ("holder") and the anode wire array. All voltages can be supplied by separate HV-supplies or voltage dividers. The baking limit is specified as 150°C for the detectors and for optionally provided in-vacuum cables and feedthroughs.

The wire array consists of two or three helical wire propagation double (delay) lines. For each dimension a differential wire pair is formed by a collection (signal) wire and a reference wire. A potential difference of 20V to 50V between signal and reference wire ensures that the electron cloud emerging from the MCP is mainly collected on the signal wires, shared between the wire layers for different position encoding directions. The anode holder has to be biased with an intermediate potential with respect to the anode wires and the MCP back potential to ensure proper charge cloud propagation and spatial broadening in the drift zone between MCP and anode wires. The optimal voltage depends on the distance between the MCP holder plate and the anode wires.

Typically the wires should have about 300V more positive potential than MCP back side and the holder about +100V with respect to the MCP back potential.

Avoid penetration of strong external electrical and magnetic fields into the electron cloud drift region (between MCP and wire anode). Electrical fringing fields can produce image distortions, magnetic fields (> 50Gauss) disturb the proper charge cloud broadening and will lead to malfunction of the anode.

### 1.1.1 Position Encoding

The position of the detected particle/photon is encoded by the signal arrival time difference at both ends of each parallel-pair delay-line, for each layer independently. While the signal speed along the delay line is close to speed of light, one can define a perpendicular signal speed  $v_{\perp}$  given by the pitch of one wire loop (typically 1mm) and the time, which a signal needs to propagate through this loop. This defines the single pitch propagation time per 1mm which is equal to  $1/v_{\perp}$  (in units mm/ns).

The corresponding ends of the delay-lines for each dimension are located on the opposite corners of the wire array terminals on the rear side. The electrical resistance of each wire is between 5 and 100Ω end-to-end, depending on the size of the delay-line and the wire type used. Corresponding ends of wires can such be identified. The four (or six) terminal pairs have to be connected to vacuum feedthroughs by a twisted-pair cable configuration (both cables of a pair must have equal lengths, within 5mm). From the feedthroughs the signals must be transmitted (after DC-decoupling) to a differential amplifier or signal transformer with equally adequate transmission cables.

The difference between the signal arrival times at the adjacent ends of each delay-line is proportional to the position on the MCP in the respective dimension. The sum of these arrival times is fairly constant with few ns for each event (see below). The time sequence of the signals can be measured by time-to-amplitude converters (TAC) or an n-fold time-to-digital converter (TDC), n is at least 4 or up to 7 (**Hexanode** with separate timing channel). As time reference the signal on the MCP back or front side can be used for correlating each particle to others or to an external trigger (TOF-measurement).

For the **DLD** detectors, the digital encoding for obtaining a 2d digital image (X/Y) is

---

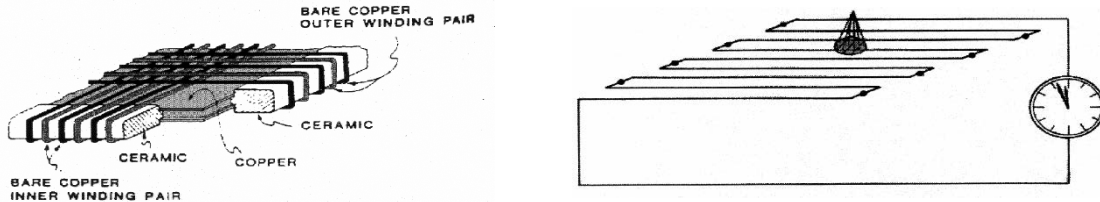
\* In the following we will refer to those detectors using the same anode only by nominating one detector version, e.g. for **DLD40** and **DLS40eT** as **DLD40** unless otherwise noted. Additional remarks, if any, will refer to the different MCP types.



$$X = x_1 - x_2 + O_x \quad \text{and} \quad Y = y_1 - y_2 + O_y \quad \text{Equation 1.1}$$

with  $x_1$ ,  $x_2$ ,  $y_1$  and  $y_2$  denominating the time for each signal,  $O_x$  and  $O_y$  are arbitrary offsets.

The fast timing signal picked up from an MCP contact or, in the case of a pulsed particle/photon source, a “machine trigger” signal can serve as time reference. The single pitch propagation time (for 1mm) on the delay line is about 0.75ns for **DLD40**, 1ns for **DLD80** and 1.24ns for **DLD120**. Thus the correspondence between 1mm position distance and relative time delay in the 2d image is twice this value: about 1.5ns, 2ns or 2.5ns, respectively. Note that these numbers are only accurate within 5% and are slightly different for each dimension. In order to calculate the position in mm from the digital X and Y values you have to take into account the bin width of your TDC and the single pitch propagation time for the respective layer.



**Figure 1.1: Operation principle of the delay-line-anode,**  
left picture from: Sobottka and Williams IEEE TS-35 (1988) 348

The **Hexanode** has an additional layer and gives over-determined (redundant) position information: It is possible calculating the two-dimensional particle position of signals from of any two of the three layers. The signals from the third layer serve as a redundant source of information for cases when signals are “lost” due to electronic dead-time (multiple hit events), non-continuous winding schemes (anode with central holes) or non-perfect electronic threshold conditions/damping on special very large delay-line anodes. With the **Hexanode** it is also possible to control their delay-lines’ intrinsic resolution and linearity, improving the overall imaging performance. The **Hexanode**’s coordinate frame  $u$ ,  $v$ ,  $w$  can be transformed into a Cartesian coordinate system by the following equations using only two of the hexagonal coordinates respectively, if the connection scheme in the next section is chosen:

$$\begin{aligned} X_{uv} &= u + O_x \\ Y_{uv} &= \frac{1}{\sqrt{3}}(u - 2v) + O_y \\ X_{uw} &= X_{uv} \\ Y_{uw} &= \frac{1}{\sqrt{3}}(2w - u) + O_y \\ X_{vw} &= (v + w) + O_x \\ Y_{vw} &= \frac{1}{\sqrt{3}}(w - v) + O_y \end{aligned} \quad \text{Equation 1.2}$$

$O_x$  and  $O_y$  are arbitrary offsets. The position in a hexagonal coordinate frame is coded by the arriving time differences from signals in opposite corners of the anode as in case of the **DLD**.

$$\begin{aligned} u &= (x_1 - x_2) * d_1 \\ v &= (y_1 - y_2) * d_2 \\ w &= (z_1 - z_2) * d_3 + o \end{aligned} \quad \text{Equation 1.3}$$

If  $1/v_i$  is the single pitch propagation time for a delay line layer  $i$  ( $v_i$  is slightly different for each layer) then  $d_i$  is given by

$$d_i = \frac{1}{2} v_i * \Delta t \tag{Equation 1.4}$$

$d_i$  must be precisely known to make the images obtained via different layer combination coherent.  $o$  is an offset value that shall unify the “time difference zero” of all three layers, i.e. it must be chosen so that geometrically the position lines for calculated  $u, v, w$  have a common crossing point, e.g.  $w$  must be zero when  $u$  and  $v$  are zero.

For the **HEX80** the single pitch delay is about 1.4ns. The exact values  $u, v, w, o$  differs from anode to anode. There relative values must be precisely determined which can be done by a self-calibration routine (for details please contact **RoentDek**).  $o$  is also a function of connection cable lengths and cable lengths all the way to the TDC/TAC inputs (and internal offsets therein) and must therefore be recalibrated whenever these parameters have changed. The single pitch delay for the **HEX120** is about 1.75ns which corresponds to a pitch of 1mm or 1.5mm, depending on the anode version which you have received (default: 1.5mm).

For detectors with central hole, the gaps in the wiring have to be taken into account. Please contact **RoentDek** for the program codes appropriate for your detector.

The linearity deviations in each delay-line layer should be calibrated to achieve optimal results. Please contact RoentDek for an auto-linearization routine and advanced position codes.

The X and Y positions can be calculated from any combination of the Equation 1.2. If for a given event more signals than from the minimum of two layers are available, it is recommended to choose signals from those two layers where the positions are most distant from the respective delay line ends (or gaps).

**1.1.2 Timing information:**

In order to determine the time difference between an outer time marker and the particle impact, the signal at the MCP contact can be used. But it is also possible to deduce the particle impact time from the delay-line signals:

If the MCP signal is used as the time-zero, the “time sum” values

$$\begin{aligned} \text{sumx} &= x1 + x2 \\ \text{sumy} &= y1 + y2 \\ \text{sumz} &= z1 + z2 \text{ (only available for Hexanodes)} \end{aligned} \tag{Equation 1.5}$$

are constant within the time resolution (less than one ns) but have a slight “position walk” which can be determined by plotting sum vs. difference (i.e. position). Thus it is also possible to deduce the particle impact time from these time sum values alone. Even if the particle timing is not of interest, the time sum measurement can be used to verify a proper detector function.

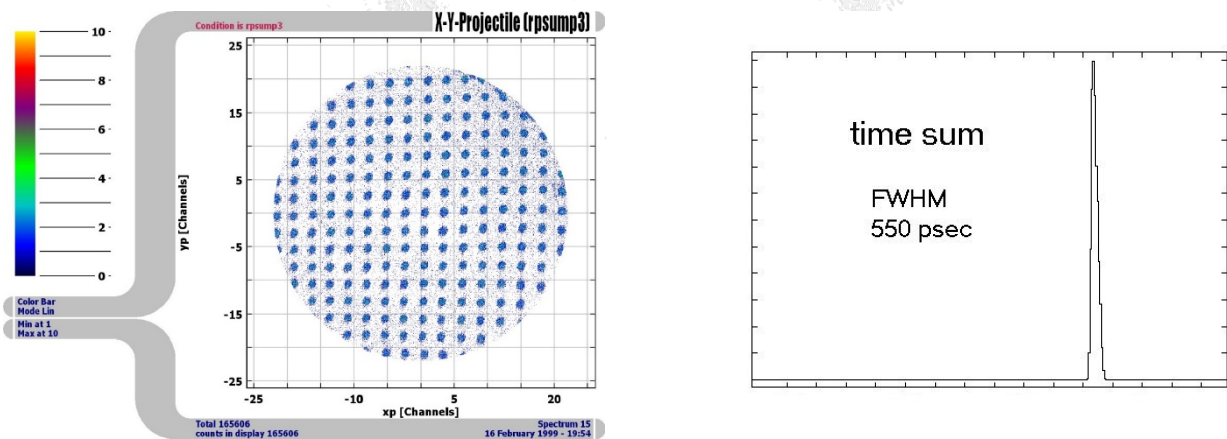


Figure 1.2: Typical imaging/timing performance of a DLD40 detector. The detector (shaded by a mask) was irradiated with  $\alpha$ -particles. Similar or better results can be achieved with adequate read-out electronics. Temporal resolution is significantly better than the local time sum width (see right picture) which indicates an upper limit.

## 1.2 Assembly of the MCP-Detector

The assembly should take place under clean and dry conditions.

### 1.2.1 List of Detector Assembly Parts

- ceramic rings, partially metal coated (for **DLD40**, **DLD80** and **HEX80/HEX75**) or metal rings/plates
- two multi-channel plates, selected for chevron configuration, matched in resistance
- metal spring clamps (for **DLD40**, **DLD80** and **HEX80/HEX75**)
- plastic M3 screws with nuts (for **DLD40**, **DLD80** and **HEX80/HEX75** only during assembly of the MCP holder)\*
- 1 delay-line anode
- Assorted small parts for cable connections (optional)

*If you have purchased the detector with the “readily mounted” option (only available with **FT12(16)TP/xxx** flange mounting) you need to remove the detector case (and may return it to **RoentDek** for receiving a refund). All connections to the anode should already be in place but the MCP must be mounted according to the directions below. You will also have to verify all anode connections and check for absence of shorts which may have occurred during transports. Therefore, please review the following instructions even if you have received a “readily mounted” anode.*

For **DLD40**, **DLD80** and **HEX80** the MCP holder with rear ceramic ring may already be placed on the delay-line anode, it is fixed by the retractable “shields” in a position that should be resumed after assembly of the MCP stack. If the rear ceramic ring is not pre-mounted (i.e. for transport safety reasons) please test-mount it now and observe the relative angle of the metallization structure. You will in any case have to remove it for assembling the MCP stack (see below). After this assembly, the rear ceramic ring has to be in about the same orientation as shown in Figure 1.3.

All parts, especially the MCP and the wire anode structure should be handled with great care. The wire array is very delicate. The ceramic rings should not be exposed to exceeding mechanical or thermal stresses. The MCP surfaces are very sensitive and should never be touched or scratched. Some “optical defects” may be seen on the MCP surfaces after removing them from the transport packing. Unless the MCP are broken (transport damage) this will not affect performance within specifications. Please read the whole assembly section before starting the mounting, see also Appendix for MCP handling.

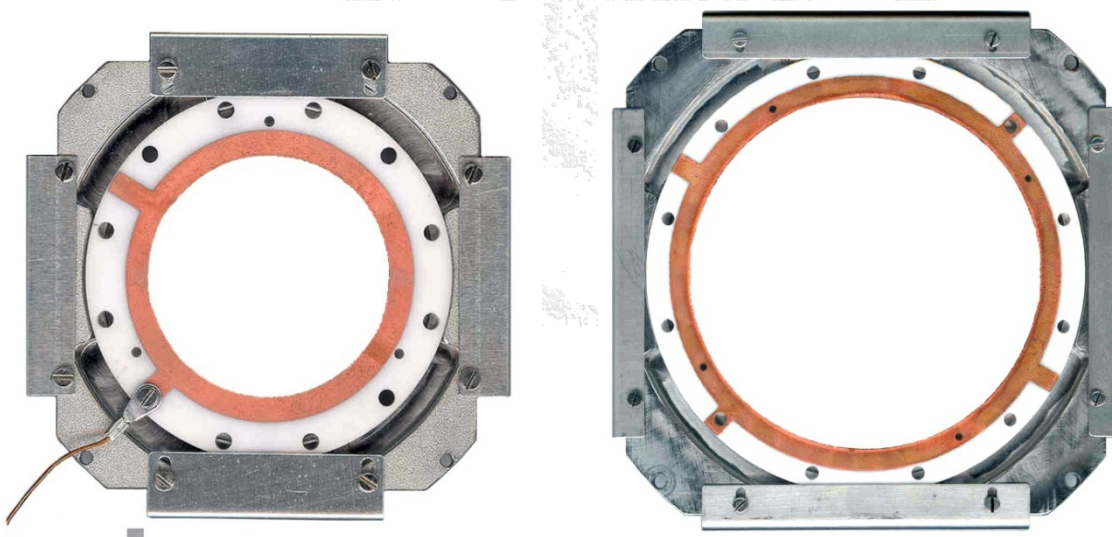


Figure 1.3: Orientation of the rear ceramic ring on the Delay-line assembly (**DLD40**, **DLD80**). For **HEX80/HEX75** the orientation is similar, but there is only one pair of flat “shields”.

### 1.2.2 Preparation

1. Verify with an Ohm meter that no dust particles have electrically shortened the anode wires. The anode contains one pair of wires for each special direction. Neither the two wires of one pair nor the wires of the different layers should be in contact ( $>10\text{M}\Omega$ ). Also verify that there is no electrical connection between the wires and the holder plate. Dust particles can be removed by gentle blow with dry air or a soft brush. Check the resistance of each of the 4 wires. From one end to the other it should be around  $5\Omega$  for the **DLD40**,  $12\Omega$  for the **DLD80**,  $17\Omega$  for the **HEX80/HEX75**,

\* For **DLD120** and **HEX120**: 6 PEEK M3 screws and 3 plastic M3 rods (the latter only during assembly of the MCP holder)

25Ω for **DLD120** and about 40Ω for the **HEX120**. These are the values for the standard **RoentDek** anodes. If you have ordered and received a special type, the resistance might be different. Note, that even after testing for the absence of a short between wires, at any time, after assembly, installation, baking or after biasing the detector, a metallic dust particle from the environment can short signal and reference wires. If such a problem persists contact **RoentDek** for advice.

For **DLD120** or **HEX120** please continue with (4).

2. Remove the ceramic ring from the assembly (if pre-mounted). Two of the shields can be retracted to liberate the stack after the M2 screws are loosened. Note, that the shields must not touch any contacts on the ceramic rings and that the spring clamps that hold the stack together are mounted with about 45° angle with respect to the delay line so that they are not touching any metal part. This orientation has to be resumed when re-assembling the detector.
3. Optionally: a mesh can be glued, soldered or spot-welded directly onto the front side of the *front* ceramic ring, such being at a position of 1.5/2mm in front of the MCP surface. However, we recommend using one of the **RoentDek** detector meshes of type **(w)Mesh 40/80/120** which can be mounted to the front ring.
4. Prepare the connection cables for the MCP detector and the delay-line anode. If you have ordered a **FT12(16)TP** you should have received these connection cables. For the MCP and holder connection 3 (single) cables are used. For the anode 4 or 6 (Hex) cable pairs with proper impedance (ideally 100-150Ω) are needed. Unless you have received special cable pairs or twisted pairs with adequate lengths you must form twisted cable pairs: The two cables of a pair must have equal lengths within a few mm. The pair must be twisted at least 3 turns per 10cm to form a well-transmitting twisted pair cable line. For connecting these cables to the delay-line terminals special 2mm connector pins are provided. The three other single cables are needed for “MCP front”, “MCP back” and “Holder” which is the metal anode body (see also next section). A fourth single cable can be used for connecting a mesh.
5. For **DLD40**, **DLD80** and **HEX80**: The cables for the MCP connections can be soldered or spot-welded directly onto the metallization of the ceramic rings or clamped to the ring with special recessed M2 nuts and screws (obtainable from **RoentDek**). Also special 3mm and/or 2mm lugs for crimping a cable can be supplied. If soldering preferred use the metallization strips which are *not* located at a hole of the ceramics. Do that *before* mounting the MCP. Alternatively a set of special M2 nuts with short M2 screws can be provided for clamping, or special spring clamps that can be placed between the rings at the position of a metallization located on a hole. Contact one side of each ring with a cable to bias “MCP back” and “MCP front” respectively.  
For **DLD120** and **HEX120** or **100**: The cable for the “MCP back” connection can be fixed by a M2 screw to the rear MCP plate. The cable for the “MCP front” connection is either clamped to the front ring with one of the M3 polyimide screws or for newer systems alternatively via an M2 screw that can be fixed to the front ring (see also Chapter 1.2.4.2).

A cable for the anode “holder” can be connected anywhere on one of the metal M2 rods in the anode, or any part electrically connected to that, see **Error! Reference source not found.**

You may clean all parts *except the MCPs* in an ultrasonic bath for a few minutes with a mild alcoholic solvent like isopropanol. MCP should only be exposed to a cleaning procedure if they have some surface contamination that cannot be removed by spraying with dry air. Please contact **RoentDek** for further advice. For MCP general handling see also instructions on the manufacturer’s web sites or in the Appendix of this manual. Touch MCPs only with care along the rim, preferably with gloves. If the MCPs need replacement mount a set with matching electrical resistance only.

Alternatively **RoentDek** can supply an intermediate shim ring with bias contact lug on demand.

Now the detector can be finally assembled, preferably under clean room conditions

### 1.2.3 Connecting the Wires to the Delay-line Anode

A proper design and use of connection cables is essential for a decent detector performance. Therefore we strongly recommend using the feedthroughs of type **FT12** for the delay-line connections (**DLD** and **HEX**). For the **DLD** the **FT12** can also accommodate the bias for the other detector parts, while for the **HEX** an additional feedthrough set is required to connect Holder, MCP front and MCP back (and an optional mesh), for example the **FT4\***. Please refer to Chapter 0 of the manual

---

\* The **FT4** and **FT12** are combined to the **FT16** feedthrough set for **HEX** detectors



even if you have not purchased this option because important features for proper cabling and signal decoupling circuits are described there.

You need a set of 4 (Hexanode: 6) twisted pair cables to connect the anode wires. In the four (six) corners of the anode's rear side each pair must be connected to the wire terminals formed as M2 stubs, preferably with the connector pins provided. Mounting the cable in a different way (i.e. by M2 nuts) is possible but not recommended, see also Chapter 0. Note that the M2 stubs are not secured against torque. If you have purchased the **FT12(16)** feedthroughs adequate cables with adequate connector pins/lugs for both ends are provided with it. Use only so much force that the cables are safely connected and are not moving when gently wiggling on them. Also connect the anode holder with a cable, wherever suitable (see also below). This cable has to supply the anode holder potential.

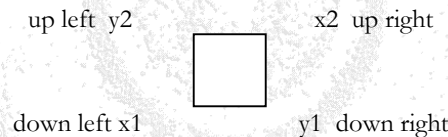


**Figure 1.4: Cables for holder and wires on DLD40, DLD80 and HEX80. The four M2 rods and the MCP holder plate are on the same "Holder" potential as the delay-line anode body. The cable can be connected anywhere on these parts.**

**Please note that this is NOT the case for the DLD120 and Hex120(100) assemblies where the MCP back plate is insulated from the Holder and carries the MCP back potential.**

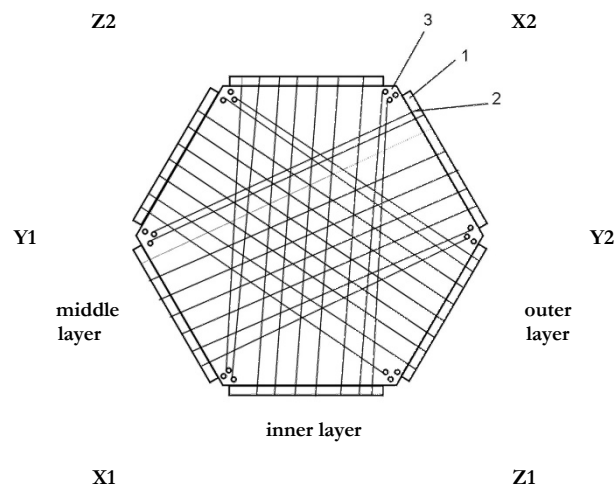
Before connecting the cables to a feedthrough it is important to distinguish the cables that lead to ends of the same single delay line wire. Both ends must receive the same voltage ( $U_{ref}$  or  $U_{signal}$ , see Chapter 2.2).

In order to later obtain an image on the PC monitor according to a phosphor screen (rear) view, the following connection scheme in the corners is recommended for the **DLD** detectors.



**Figure 1.5: Orientation of x and y position terminals on anode viewed from the rear side, the outer delay line wires. In this position the sliding shields are recommended to be placed left and right on the (inner) Y-layer side.**

For the **Hexanode**, the following wiring scheme is mandatory to comply with the position computations in Equation 1.2:



**Figure 1.6: Rear view of a Hexanode with suggested cable connection**

### 1.2.4 Assembly of the MCP-stack

If you have received a **DLD120** or **HEX120(100)** please refer to Chapter 1.2.4.2

#### 1.2.4.1 Assembly of the MCP-stack for the **DLD40**, **DLD80** and **HEX80**

A cartoon about the assembly of the MCP stack for the **DLD40**, **DLD80** and **HEX80** can be found on our web-site in the *MOVIES* section. There you can also find cartoons showing the mounting of the MCP stack to the anode.

By now you have to decide if you prefer to solder the cables for the MCP contacts directly to the contact pads on the ceramic ring, as recommended. Note, that even for UHV environment small amounts of lead-free solder/flux are usually tolerable. All parts should be cleaned after the soldering.

If you prefer not to solder the cables to the ring, fix a cable with the provided M2 screw with the special nut on the front ceramic ring now. The cable can either be crimped to a contact lug and fixed with a M2 screw or wound around this screw without using the lug.

If you prefer not to solder the cables directly onto the rings and have received (or prepared your own) connecting lugs and a screw set fix a cable to the front ceramic ring now. The cable to the feedthrough must first be crimped (or soldered) to the contact lug with 3mm eye-let and fixed with a special recessed M2 nut and a countersunk M2 screw (4mm long for **DLD80/HEX80** or 3mm long for **DLD40**), see Figure 1.7.

If you have purchased a mesh from **RoentDek** you may mount it now to the front side of the front ceramic ring with the same (or other) recessed M2 screws/nuts at a desired distance from the front ring. It should be fixed on at least two (for zero distance) or more positions and must be connected with a bias cable to a feedthrough. If you have purchased any of the **FT12(16)TP** products you may connect this bias cable to the “X” line on pin1 of the **FT12TP** or in case of **HEX**, to the vacant MHV/SHV feedthrough on the **FT16TP** feedthrough assembly (it is then recommended also using a **HFST** for biasing the mesh, see Chapter 0



Figure 1.7: Connections to a ceramic ring. Left: cable clamped to a “front” ring (MCP side visible). Middle/right: cable clamped to a back ring with 3mm lug, countersunk M2 screw and special M2 nut.

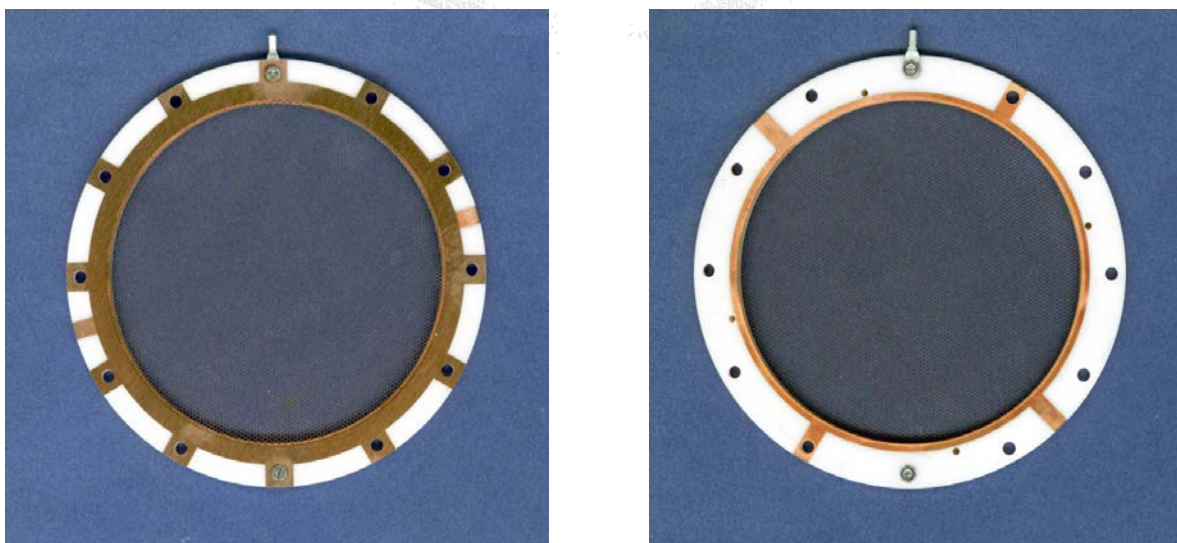


Figure 1.8: Free-standing mesh mounted to the MCP front ring (left: front side, right rear side of the front ring).

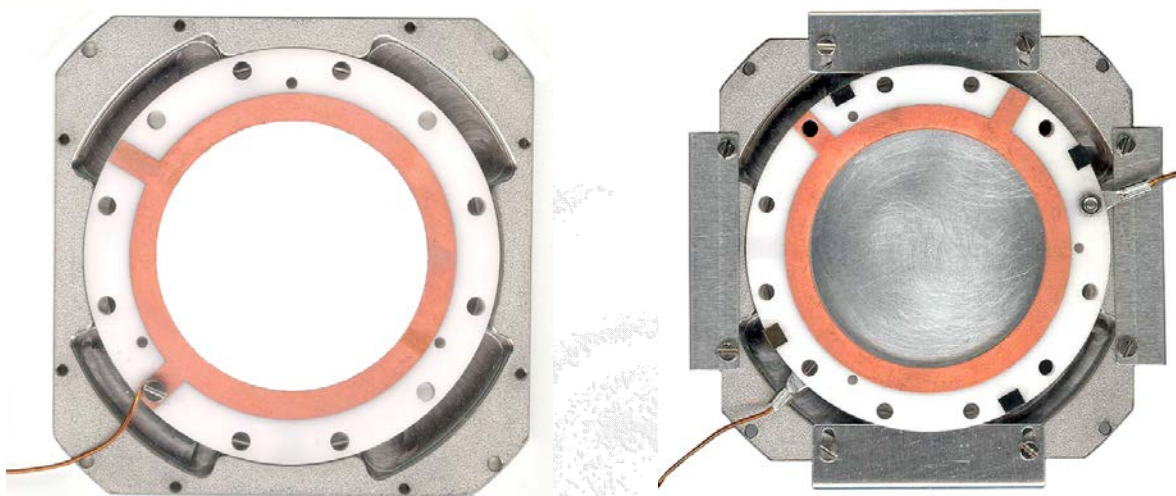


Depending on the connecting scheme of the MCP contact there may be mechanical conflicts for the mesh mounting and/or potential electrical hazards for the detector operation at certain mesh voltages. We recommend contacting **RoentDek** for further advise when using a mesh close (i.e. < 3mm distance) to the MCP front ring.

The MCP back contact on the rear ceramic ring can be made in the same way as on the front ring. For most standard **RoentDek** detector stacks with a total MCP stack thickness of 3mm (not for **DLD40EP** and **DLD80eT/Hex75eT**) the cable for biasing the MCP stack's back side can alternatively be connected via a contact spring clip (see Figure 1.17).

It is very important

- that no part of the screw/nut protrudes more than 0.8mm towards the holder plate (a screw tip must end in a recessed nut or just on the nut edge). Use only countersunk M2 screws for fixing things on the ceramic rings.
- to rotate the ring on the holder plate such that the screw is located at or near the holes along the diagonal (see Figure 1.8). Any other contact or mounting screw (i.e. for a mesh) cannot be on the same azimuthal position later.



**Figure 1.9: Recommended ring orientations on a DLD40 assembly (DLD80 & HEX80 similar). Left picture: cable connection of this type without lug. Cable connection pads must rest in the recessed parts of the holder plate near the diagonal. Right picture: the assembled MCP stack with recommended orientation. Here, lugs with crimped wires crimped are used. Please follow the next figures/directions to achieve such a detector mounting**

After having safely fixed the contact cable(s) on the ceramic ring(s):

*In this and the following assembly drawings, no cables are shown.*

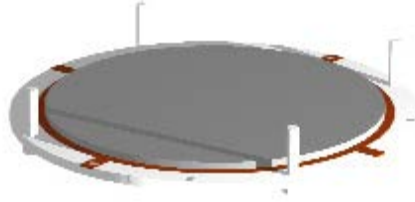
1. Place the front ceramic ring (metallization on both sides), with the contact for MCP front side pointing upward, with inserted plastic screws from below on a flat table:



**Figure 1.10: Assembly of MCP-stack - Stage 1 (DLD40, DLD80 & HEX80)**

2. Remove one MCP (for first stage of the stack) carefully from its transport package and place it centered onto the ceramic ring. Unless otherwise noted any of the delivered MCPs can be used for this and will have a mark on the outer rim defining the input (front) side, indicating the MCP pores' tilt angle in the azimuthal plane. This side has to face down and will be in contact with the front ceramic ring. Remember the position of the mark. The second (and possibly a third) MCP will be placed with its mark also facing down and should be rotated by about 180 azimuthal degrees with respect to the mark position on the MCP under it. In a side view cross section of the stack, the pores of the MCP would resemble a (broad)

“v” shape (or chevron), or a “z” shape for triple stacking. Such an angle orientation is very important for proper stack performance, however, any relative azimuthal angle between  $150^\circ$  and  $210^\circ$  will serve as well as having exactly  $180^\circ$  between marks.



**Figure 1.11: Assembly of MCP-stack - Stage 2a (DLD40, DLD80 & HEX80)**

A shim ring may be placed between the MCP stages of the stack. Usually, the delivered MCPs will be matched in resistance within 10% for direct stacking. If not, a shim ring *with contact lug* must be used with cable connection to a feedthrough for bias via a high voltage supply. Please contact **RoentDek** in such a case. However, even for matched MCP placing a shim ring can be recommended.

- **DLD40, DLD80, HEX75** with 60:1/40:1 MCP: there is no intermediate contact ring recommended, the second (and possibly third) MCP can be placed in direct contact with each other.
- **HEX80** with 60:1 MCP: a shim ring can optionally be supplied to reduce the active MCP diameter to 75mm. This is beneficial for some multi-hit applications.
- **DLD40EP/DLD75eT, HEX75eT** with 80:1 MCP: a shim ring may be used for reducing ion feedback and increased gain at lower bias (but may affect temporal resolution adversely).



**Figure 1.12: Assembly of MCP-stack - Stage 2b (DLD40(/2), DLD80 & HEX80/HEX75)**

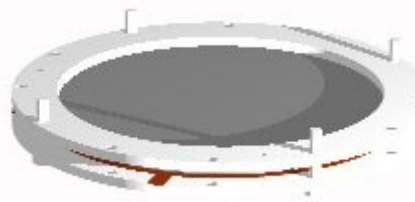
After possibly placing a shim ring on the first MCP the second (and optionally third) MCP can be stacked on top of the first one, observing the position of marks (see above). Dust particles that may have settled on MCP surfaces can usually be blown away by dry air over the surface.

*It is especially important to avoid that dust particles settle between the MCP during assembly.*

Touch MCPs only with care along the rim, preferably with gloves. See also the Appendix of this manual for general MCP handling. After the stack is piled you have to check if it is well centered, adjustments can be done by carefully shifting individual MCPs sideways.

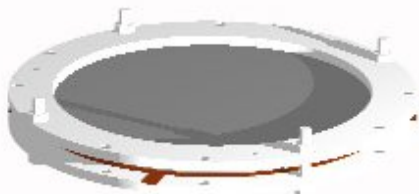
3. Place the second ceramic ring (with the MCP back contact facing down) carefully on the MCP-stack. The plastic rods will guide the alignment.

**Note, that the contact positions on the two ceramic rings must not oppose each other.**



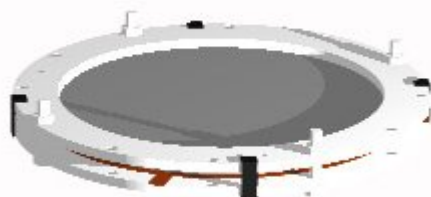
**Figure 1.13: Assembly of MCP-stack - Stage 3-1 (DLD40, DLD80 & HEX80)**

Now fix the stack with the plastic nuts gently and very carefully. Use only so much force (“hand-tight”) that the rings and MCP cannot move any more.



**Figure 1.14: Assembly of MCP-stack - Stage 3-2 (DLD40, DLD80 & HEX80)**

The MCP holder stack can now be finally fixed with 4 spring clamps. Make sure that one of the rings is close to the cable contact of the back ring and the other three at about 90° relative angle to that (see Figure 1.9). No clamp should be right at the position of a contact pad on any side of the rings.



**Figure 1.15: Assembly of MCP-stack - Stage 3-3 (DLD40, DLD80 & HEX80)**

Now remove the plastic screws again. The MCP holder stack can be used as an independent unit.



**Figure 1.16: Assembly of MCP-stack - Stage 3-4 (DLD40, DLD80 & HEX80)**

For MCP stacks with 3mm thickness the MCP back side can be contacted by a special spring clamp. Insert it between the rings at the position of a contact pad around a hole on the rear ceramic ring, i.e. electrically in contact with MCP back. Make sure that MCP front ring has no contact pad on the opposing side at the same position. The spring clamp has a 1mm stub for a connector (obtainable from **RoentDek**).



**Figure 1.17: MCP stack with spring clamp for the MCP back cable (DLD40, DLD80 & HEX80)**

4. Now the MCP-stack can be mounted to the anode by inserting it into the butterfly-shaped indent of the holder plate and fixing it with the movable shields. Only uncoated parts of the ceramic ring shall rest on the holder plate, i.e. the spring clamps and protruding contacts from the back ring must be located along the diagonal of the plate, not touching it.

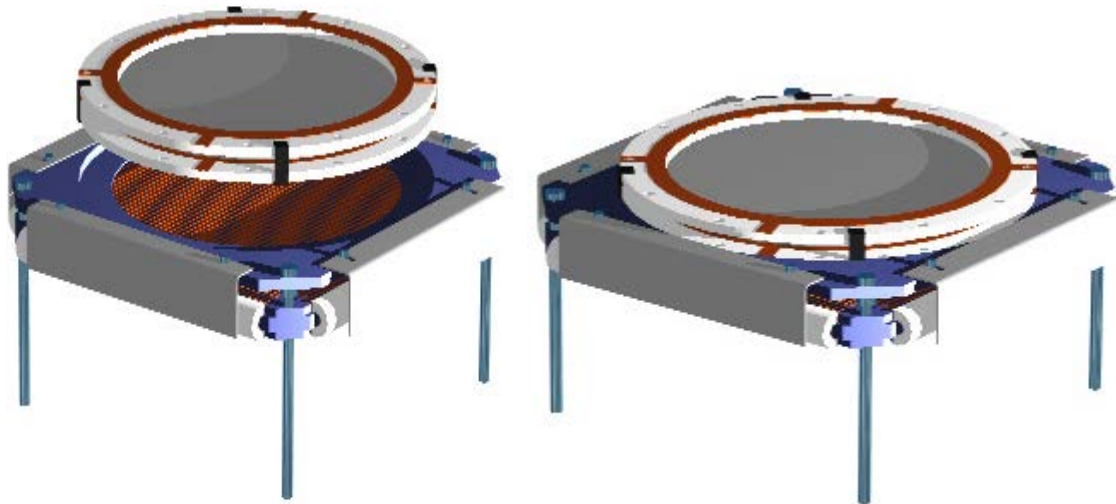


Figure 1.18: Assembly of MCP-stack - Stage 4 (DLD40 & DLD80)

Check with an Ohm meter that there is no electric contact between “MCP back”, “MCP front” and “holder” plate. There should be a resistance in the 10-100M $\Omega$  regime between “MCP back” and “MCP front”. In the presence of humidity the MCP stack resistance may be less than the default value.

For disassembly reverse all steps.

For the **HEX80**, the same butterfly-shaped MCP holder plate as for the **DLD80** is used. Additionally, a hexagonally-shaped intermediate plate connects the standard **DLD80** holder with the **Hexanode**. The shields are replaced by a pair of metal sheets that hold the MCP stack in position.

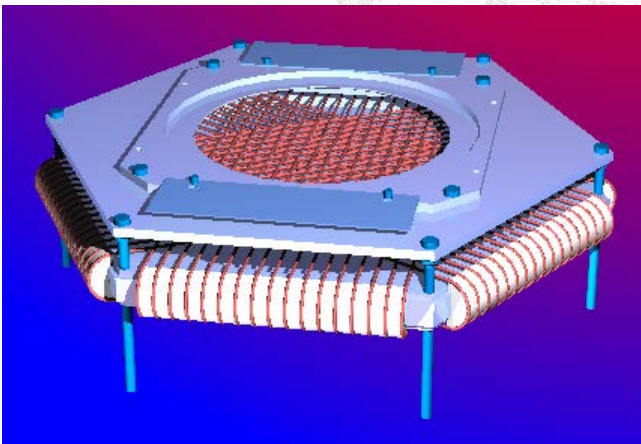


Figure 1.19: Hexanode with holder

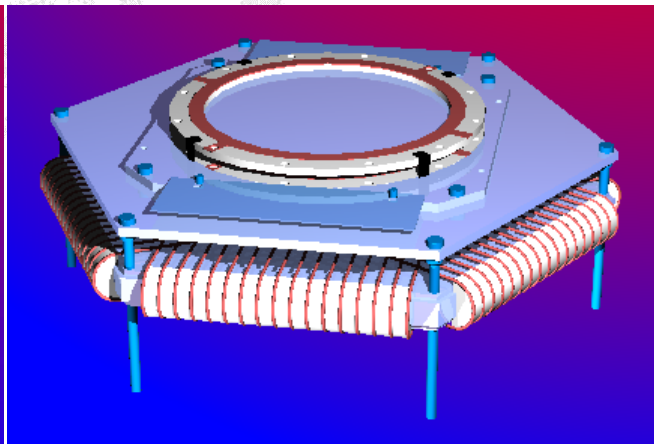


Figure 1.20: Hexanode with mounted MCP-Stack

#### 1.2.4.2 Assembly of the MCP-stack for the DLD120 and HEX120

A cartoon about the mounting of the MCP stack for the **DLD120** and **HEX120(100)** can be found on our web-site in the MOVIES section. There you can also find cartoons showing the mounting of the MCP stack to the anode.

For the 120mm MCP size (or 100mm) the mounting is different than for the 40 or 80mm MCP sizes, no ceramic rings are used. Instead, the MCPs are fitted between a metal square-shaped rear plate which mates to the delay-anode and a metal front ring. The rear plate and the front ring have an indentation for the MCP on one side. The MCP stack is fixed by 6 special M3 screws made from PEEK which is an insulating UHV-compatible polyimide material.

Only on older systems M2 rods from the same material are also used to fix the MCP stack to the anode.

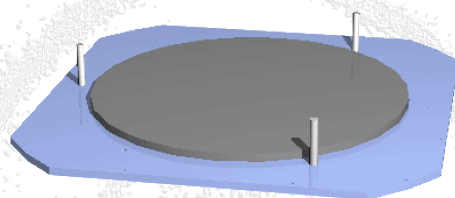


For newer systems (without polyimide M2 rods) it is not necessary to remove the pre-mounted MCP rear plate from the anode for mounting of the MCP now:

1. Place the rear plate with the indentation for the MCP pointing upward according to the sketch below. Screw the three M3 guide rods symmetrically into three of the six M3 tapped holes. Remove the MCP carefully from their transport package and insert the first one (the designated rear MCP in the stack) centered into the indentation, with the bias angle marker (triangle on the outer rim on one side) pointing upward. For MCP general handling see also instructions in the Appendix of this manual. Touch MCPs only with care along the rim, preferably with gloves.

Unless otherwise noted, any of the supplied MCP can be selected for the position in the stack. The second (and possibly a third) MCP will be placed with its mark also pointing upwards and should be rotated by about 180 azimuthal degrees with respect to the mark position on the MCP under it. In a side view cross section of the stack, the pores of the MCP would resemble a (broad) “v” shape (or chevron), or a “z” shape for triple stacking. Such an angle orientation is very important for proper stack performance, however, any relative azimuthal angle between 150° and 210° will serve as well as having exactly 180° between marks.

Optionally, shim rings can be supplied for being placed between MCP which may improve overall gain homogeneity and (for **HEX120**) shall reduce the active MCP diameter to 100mm (which is beneficial for some multi-hit applications). Usually, the delivered MCPs will be matched in resistance within 10% for direct stacking. If not, a shim ring *with contact lug* must be used with cable connection to a feedthrough for bias via a high voltage supply. Please contact **RoentDek** in such a case

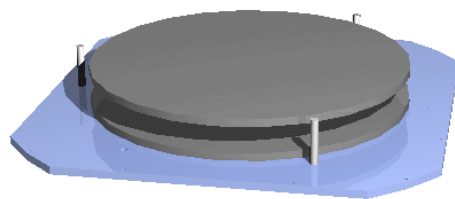


**Figure 1.21: Rear metal plate with one MCP (DLD120 and HEX120)**

After stacking the second (and possibly third) MCP carefully onto the first (with the bias angle marker pointing upwards and rotated with respect to the lower MCP's mark by about 180°) make sure that the MCPs are well-aligned with each other and are centered in the indentation, adjustments can be done by carefully moving the individual MCPs on the ring.

*It is especially important to avoid that dust particles settle between the MCP during assembly.*

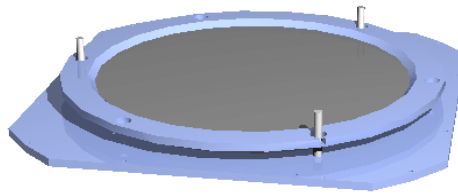
Dust particles that may have settled can usually be blown away by spraying dry air across the MCP surface.



**Figure 1.22: Assembly of MCP-stage 2 (DLD120 and HEX120)**

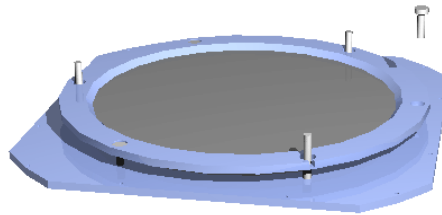
If the MCPs need replacement mount a set with matching electrical resistance only or employ a shim ring with contact lug for intermediate bias (see above).

2. Place the front metal ring with the indented side facing downward on the MCP. The guide pins will help in the alignment. **It is very important that the MCP stack is well centered and will fit into the indentation of the front ring.**

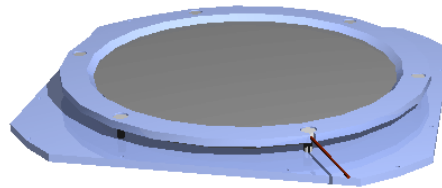


**Figure 1.23: Assembly of MCP-stack - Stage 3-1 (DLD120 and HEX120)**

Now fix the stack with three plastic screws very carefully and only lightly. Due to the indentions in the rear plate and the front ring, the MCP will not fall out even if the screws are not entirely tight. Remove the guide pins and add the other three screws. Once all screws are in place fix them again slightly without excessive force



**Figure 1.24: Assembly of MCP-stack - Stage 3-2 (DLD120 and HEX120)**



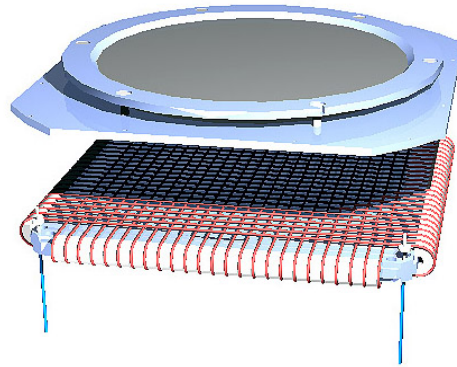
**Figure 1.25: Assembly of MCP-stack - Stage 3-3 (DLD120 and HEX120)**

3. Now the MCP back contact cable can be fixed to the rear metal plate on any of the M2 threads along the edges.

The MCP front contact cable can be fixed to the front ring likewise on a M2 threaded hole or as in Figure 1.25. For this remove the screw from the whole with the gap for the cable, insert the MCP front contact cable and re-fix the screw as tight as the others.

On older systems, the mounted MCP stack now has to be fixed to the anode via Vespel M2 rods in the corners of the delay-line anode using nuts on either side of the corresponding mounting holes in the rear plate (or the wing rails in case of **HEX120**). It is only necessary to sink the M2 polyimide rods by 3-4mm into the anode body, so that they are safely fixed.

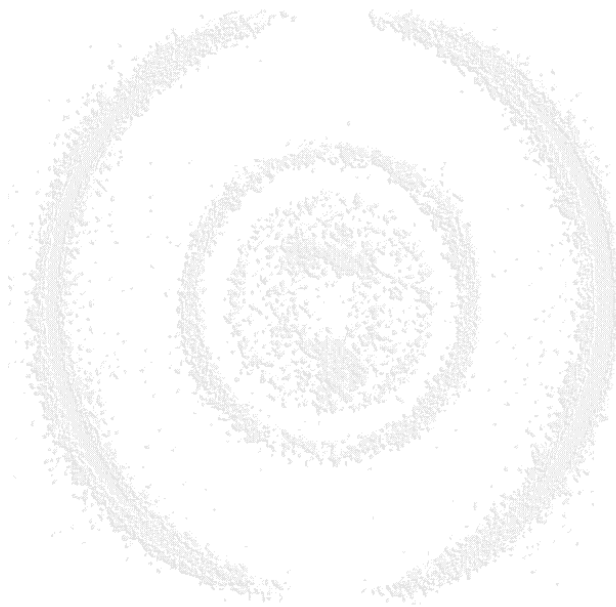


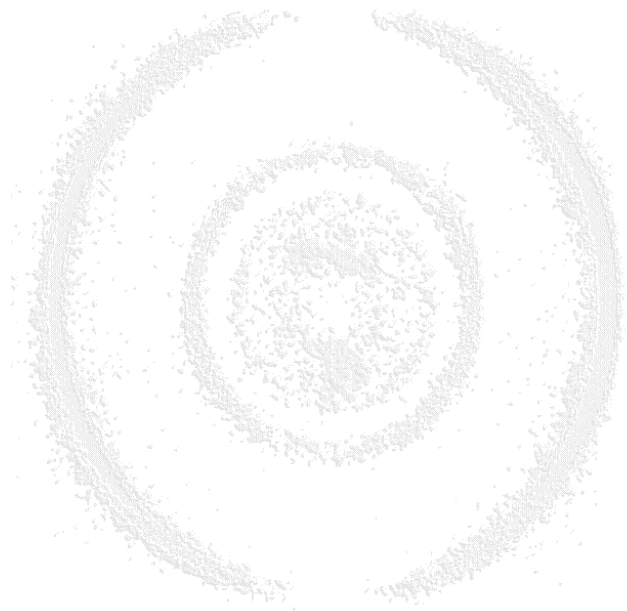


**Figure 1.26: Assembly of MCP-stack - Stage 4 (DLD120 and HEX120) only for old systems**

The recommended distance between the MCP back plate and the anode body plate is about 8mm.

A woven potential mesh wMesh120 can be supplied for being placed on the MCP front side. Please contact **RoentDek** for this option.





## 2 Mounting of the Detector and cable connections via vacuum feedthrough

**RoentDek** provides the **FT12** and **FT16** products (with or without mounting option) to allow a proper cable feeding through the vacuum wall. The **FT16** is a combination of an **FT12** feedthrough and an **FT4** feedthrough (the latter also used for the **DET40/75** timing detectors). These products can be completed by airside decoupling circuits forming the **FT12TP** and **FT16TP** products (not for operation with older **DLATR6/8** units). The maximum voltage rating of the **FT12** and the standard **FT4** feedthroughs is 4kV, likewise, the flange mounting is also specified up to this rating\*. The detector can either be custom-mounted to an experimental setup or to a mounting flange. **RoentDek** provides a product option for each detector type for mounting it onto a flange of “Conflat” norm. The minimum (and default) size of the flange is given by the detector dimension. However, mounting on larger flanges are possible and often beneficial.

If you do not want to or cannot mount the detector in such a way it is strongly recommended to still use the **RoentDek FT12TP** or **FT16TP** cable feedthrough(s) and signal decoupling plugs. For a custom mount to an existing experimental setup we recommend using the outermost threaded holes (in the “holder”) to fix the detector to your experimental setup, e.g. employing the supplied threaded rods in the shipping mount. Please note that the holder plate/the threaded rods will usually be biased during operation at a different potential than the mating part of your experimental setup. A proper insulation is needed. One (or two for **FT16TP**) DN35CF port(s) must be in the vicinity of the detectors (distance <50cm).

*Notice: It is important to have at least 2mm distance between any part of the detector and any other metal part of a setup, unless the voltage difference is small during operation.*

As a thumb-rule, at least 1mm distance for every 1000V of voltage difference should be allowed, assuming also absence of sharp edges or tips.

*If this is not fulfilled, discharge can occur during operation with the consequence of possible damage of the detector or the electronics.*

One can use sheets of Kapton for security if distances appear too small for safe operation. Please contact **RoentDek** for options.

*The vacuum port where the detector is mounted must have at least 100mm open diameter for DLD40, 150mm for DLD80, 200mm for HEX80/HEX75 and DLD120 and 250mm for HEX120 and DLD150. If the detector shall come to rest within the port/tubing of this minimum diameter it may be required to care for extra insulation.*

### 2.1 Mounting of the Detector on a Vacuum-Flange

If you have purchased the flange mounting option fix the stainless steel support ring via the outer threaded M2 rods to the delay-line anode. You may use one of these thread bolts to supply the anode holder voltage with an appropriate cable. Allow at least 30mm distance between support ring and delay-line anode.

Then mount the support ring with 8 ceramic insulators and 8 nuts using the M3 threaded bolts onto the flange. The threaded bolts are grinded at one end. This end must be on the flange side to avoid air pockets in the tapped holes of the flange. The **HEX80** and **DLD150**, **HEX120** or any other detector’s mounting on a CF250 or CF300 flange, special M6-to-M3 adapter rods are provided.

**Please note that the ceramic insulators will not tolerate excessive force when fixing the nuts.**

Adjust everything parallel to the flange and fix the nuts. The height above flange of the detector can be varied by choosing specific distances for fixing the nuts on the M2 and M3 rods. Make sure to allow sufficient distance for slipping the wire contact pins for the delay-line-terminals on and off. In case you need to further reduce distance to the flange it is possible to alternatively contact the cable pairs by 2mm lugs and nuts on the wire terminal. Please see advice from **RoentDek** before choosing this option.

Additional cartoons and drawings about the mounting of the **DLD** and **HEX** detector to a mounting flange can be found on our Web Site.

---

\* Please contact **RoentDek** for options of biasing MCP front up to -6kV or for special mountings/signal decoupling rated to even higher voltage (“floated detector operation”).

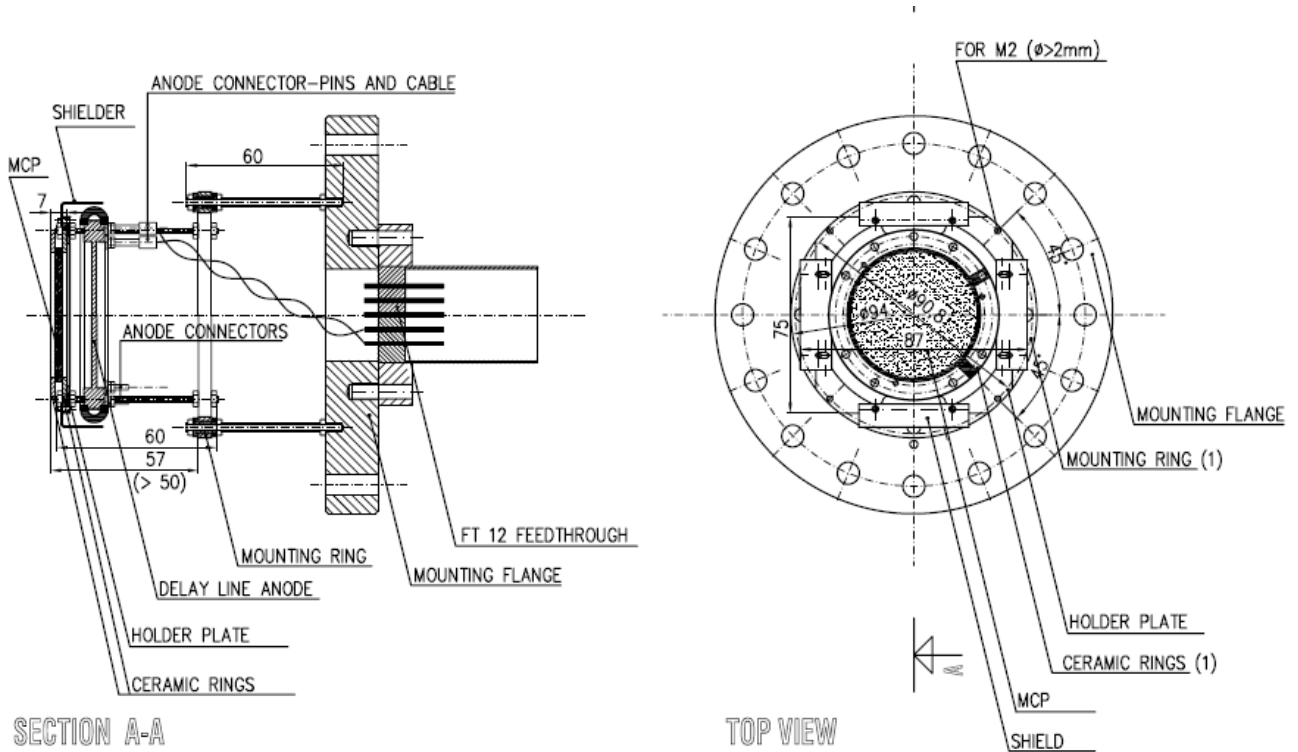


Figure 2.1: Sketch of the detector with mounting flange (only flange mounting option, here: FT12TP/100). For connecting a Hexanode, the same 12-pin feedthrough is used and an additional set of at least 3 MHV or SHV feedthroughs (e.g. the FT4) is needed for connecting the MCP front, MCP back, Holder (and optionally a mesh).

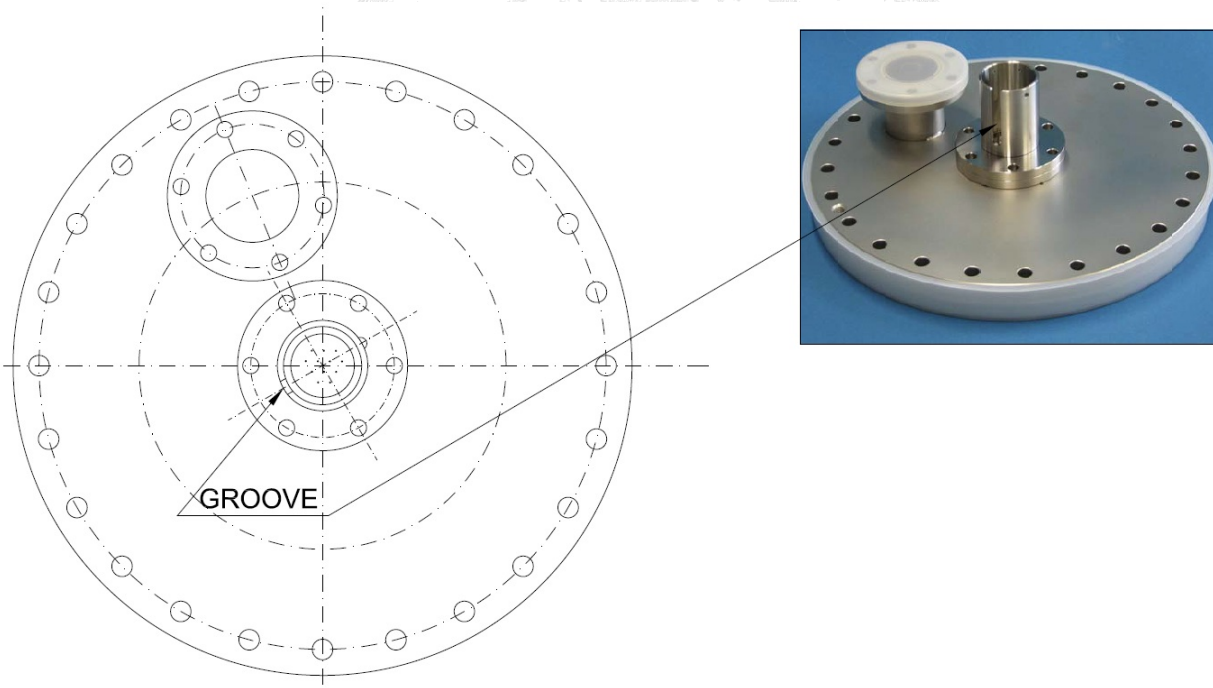


Figure 2.2: CF200 flange with two CF35 ports for mounting a Hex80 detector. It is recommended to fix the FT12 12-pin feedthrough on the center port in an orientation that the groove points perpendicular (or as close to that as possible) to the direction of the off-center port. This avoids spatial conflicts that can occur for certain item combination in the FT16TP product package.

## 2.2 Connecting the Signal Cables to a Feedthrough Flange

In the following the connection scheme to the **FT12** feedthrough flange is described. This flange is used for airside coupling to the **FT12TP(hex)** signal decoupling plugs. The following connection schemes are also compatible with earlier read-out concepts (**FT12/16** with **DLATR6/8**). For the **DLD** detectors the **FT12** offers also feedthrough leads for the remaining detector contacts (i.e. for the MCP and Holder), with **HEX** detectors require additional feedthroughs like in the **FT16** product assembly.

Unless you have purchased the flange mounted option you will usually receive a spool of Kapton isolated cables (for **DLD**) which can be used in UHV. You need to produce single and twisted-pair cables of sufficient lengths as described before in this section. The cables should only be as long as necessary. Especially the quality (amount of “ringing”) of the MCP signal is usually better if the connection cable is very short. If you have purchased a Hexanode without flange mounting option you have receive a set of cables with two parallel wires (about 0.5m long) for connecting the Hexanode delay-line.

For the **DLD** connect all 8 cables from the delay-line and the other 3 (or 4) high voltage cables (MCP front, MCP back, anode holder plate and optional mesh) from the vacuum side of the feedthrough flange. Figure 2.3 shows the **FT12** flange from the vacuum side.

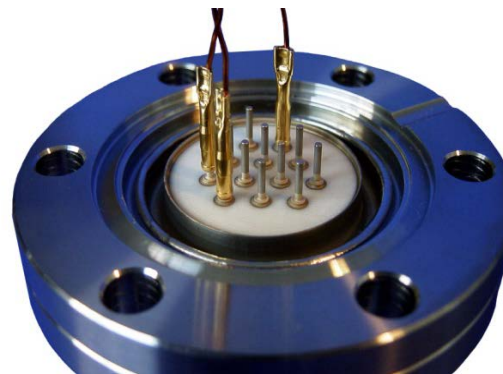
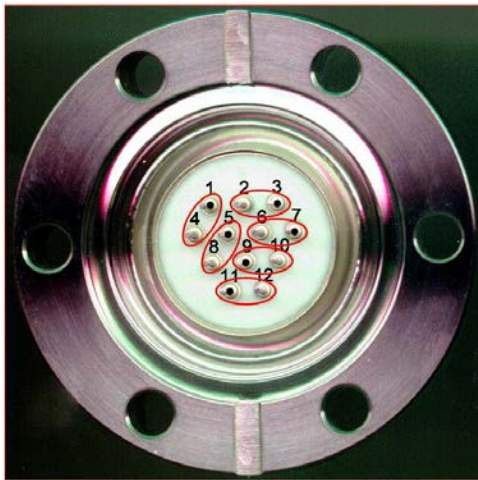


Figure 2.3: Pin numbers at the FT12 flange (the air-side guiding groove points upwards) and cable connections.

Unless you have purchased the flange mounted option you will usually receive a spool of kapton-shielded cables which can be used in UHV. You may need to produce single and twisted-pair cables of sufficient lengths as described before. The cables should only be as long as necessary. Especially the MCP signal quality (amount of “ringing”) is usually improved if the connection cables are kept as short as possible.

For the **DLD** connect all 8 cables from the delay-line and the other 3 (or 4) in vacuum cables for MCP front, MCP back, anode holder plate and optional mesh from the vacuum side of the 12-pin feedthrough flange according to Table 2.1. In case of a Hexanode detector, the 12-pin feedthrough is only used for the anode terminals (according to Table 2.2 while the other detector contacts are connected via separate feedthroughs, e.g. the **FT4** which is part of the **FT16(TP)** or via individual coaxial SHV or MHV feedthroughs.

Pin number FT12 flange	Function	FT12TP channel	FAMP8/CFD8b channel	ATR19 channel	HM1/TDC8HP channel
No. 1	X (e.g. Mesh)				
No. 2	MCP front	No. 1	No. 7 or No. 8	No. 1 or No. 2	“start” / 8
No. 3	MCP back	No. 2	No. 7 or No. 8	No. 1 or No. 2	“start” / 8
No. 4	Anode Holder				
No. 5	x <sub>1</sub> -reference	No. 3	No. 3	No. 3	x1 / 1
No. 6	x <sub>2</sub> -signal	(No. 4)	(No. 4)	(No. 4)	
No. 7	x <sub>2</sub> -reference	No. 4	No. 4	No. 4	x2 / 2
No. 8	x <sub>1</sub> -signal	(No. 3)	(No. 3)	(No. 3)	
No. 9	y <sub>1</sub> -reference	No. 5	No. 5	No. 5	y1/ 3
No. 10	y <sub>1</sub> -signal	(No. 5)	(No. 5)	(No. 5)	
No. 11	y <sub>2</sub> -reference	No. 6	No. 6	No. 6	y2 / 4
No. 12	y <sub>2</sub> -signal	(No. 6)	(No. 6)	(No. 6)	

Table 2.1: FT12TP pin description for DLD detectors



The red oval marks in Figure 2.3 define the pins for twisted cable pairs (1/4 and 3/2 pairs only for Hexanode). When connecting the delay-line anode please give special attention to the assignment of neighboring pins 5 and 76 which are NOT attributed to cable pairs from the same anode terminal, likewise for pins 1 and 2 in case of the Hexanode.

Pin number FT12 flange	Function	FT12TP hex channel	FAMP8/CFD8b channel	ATR19 channel	TDC8HP/fADC channel
No. 1	z <sub>1</sub> -reference	No. 1	No. 1	No. 7	5
No. 2	z <sub>2</sub> -signal	(No. 2)	(No. 2)	(No. 8)	
No. 3	z <sub>2</sub> -reference	No. 2	No. 2	No. 8	6
No. 4	z <sub>1</sub> -signal	(No. 1)	(No. 1)	(No. 7)	
No. 5	x <sub>1</sub> -reference	No. 3	No. 3	No. 3	1
No. 6	x <sub>2</sub> -signal	(No. 4)	(No. 4)	(No. 4)	
No. 7	x <sub>2</sub> -reference	No. 4	No. 4	No. 4	2
No. 8	x <sub>1</sub> -signal	(No. 3)	(No. 3)	(No. 3)	
No. 9	y <sub>1</sub> -reference	No. 5	No. 5	No. 5	3
No. 10	y <sub>1</sub> -signal	(No. 5)	(No. 5)	(No. 5)	
No. 11	y <sub>2</sub> -reference	No. 6	No. 6	No. 6	4
No. 12	y <sub>2</sub> -signal	(No. 6)	(No. 6)	(No. 6)	

**Table 2.2: FT12(TP) pin description for HEX detectors**

Verify proper anode cabling with an Ohm meter. Check for

- proper resistance between the ends of all wires (e.g. between pin 5 and pin 7),
- absence of shorts of any wire to ground or to any other detector part,
- absence of shorts between any of the wires,
- absence of shorts between the other detector parts.

A “short” in this respect is any resistance < 10MΩ (except for the resistance between MCP back and front, which may be smaller, see next section).

If you perform these checks from the air side of the feedthrough make sure to identify the pin numbers correctly (mirror-inverted compared to Figure 2.3). **RoentDek** can supply a test plug to ease this verification task. Some of the tests can be done more efficiently via the **RoentDek** signal decoupler plug (see next section). A cabling error which cannot be detected by verifying the cables with an Ohm meter from the feedthrough air-side alone (e.g. when the parts in vacuum are not accessible any more) is for example a swap between pin 6 and 8.

If a connector pin is too close to the chamber wall or a neighboring pin, this may result in a discharge during detector operation, with consequences to the electronics and detector (see above). In case of **DLD** please give extra attention to pins 1 and 2, which can have especially high potential relative to the others.

### 2.3 The FT12TP (hex) – Feedthrough Flange with Signal Decoupler

The **FT12TP** feedthrough and signal decoupling option allows using any adequate amplifier and timing discriminator or recording electronics to operate a **RoentDek DLD** (or **HEX**, see also **FT16TP** in the next section). Examples for adequate amplifier/CFD are the **RoentDek ATR19** units or the **FAMP1/3/6/8** (amplifier only, with output to CFD or fast-ADC follow-up electronics).

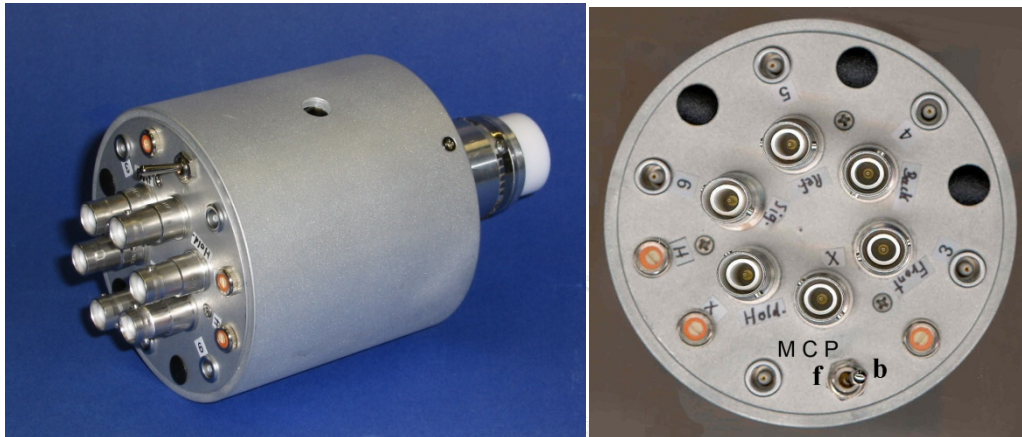
The **FT12TP** for DLD contains the standard 12 pin feedthrough **FT12** for the in-vacuum cables as described above and an air-side connector plug. The plug provides adequate RC decoupling circuits and special transformer circuits to turn the differential delay-line signals into single-line signals with 50Ω line impedance output connectors. The detector voltages are supplied via SHB input cables sockets:

U <sub>Reference</sub>	Reference wires' bias
U <sub>Signal</sub>	Signal wires' bias
U <sub>Holder</sub>	Anode-plate (Holder) bias, not in hex-version
U <sub>MCP front</sub>	MCP front bias, not in hex-version
U <sub>MCP back</sub>	MCP back bias, not in hex-version
U <sub>X</sub>	optional “X” potential, can be used for a mesh or intermediate MCP bias, not in hex-version



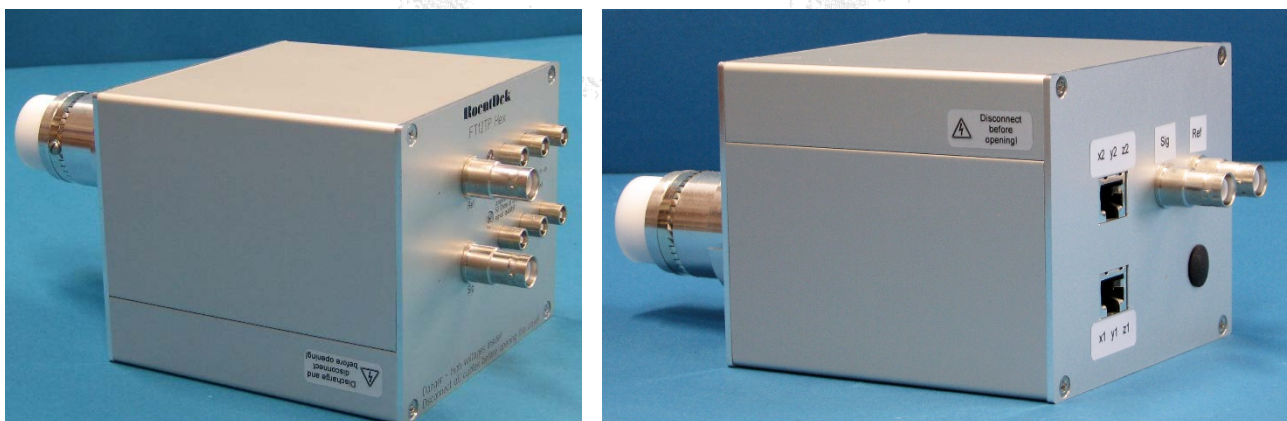
The “raw“(unamplified) signals from the MCP contact and/or delay-line contacts are delivered to five LEMO 00 series type connectors\*.

Adjustable resistors (potis 0-200Ω) for “Holder” and “X” contact and for the MCP allow improving signal quality from an MCP contact. The standard FT12TP decoupling plug has a switch for selecting the source of the MCP signal, i.e. optional pick-up from MCP front contact or MCP back contact. The other side of the MCP is then connected to the terminating poti. An in-line resistor can be adjusted from the side and changes the pulse height of the MCP signal but also alters the signal shape in combination with the other potis. Fine-tuning these potis will result in a decent MCP signal shape adequate for further electronic processing in follow-up timing electronics. Note that the signal outputs from MCP front and back can have different shapes and require different fine-tuning. Any metal part (biased mesh, electrode) close to the MCP can affect the signal shape and it is recommended to place a signal termination circuit on it, too. The “X”-line of the **FT12TP** poti.



**Figure 2.4: FT12TP Plug with switch for front (f) and back (b) MCP pickup. The hole in the ring case allows access to the in-line poti.**

The so-called FT12TPhex plug for the Hexanode is very similar to the FT12TP for DLD but has 6 lemo outputs for the delay-line anode signals and two SHV bias inputs for  $U_{ref}$  and  $U_{sig}$ . It serves as connector/decoupling unit only for the Hexanode while the bias and signal pickup to the remaining parts of the detector is routed via different feedthroughs and decoupling/terminating circuits. The FT12TPhex circuit can also be supplied in a square-shaped case which contains more flexible circuits, i.e. one can use an alternate biasing scheme for special detector setups and it allows a differential signal transmission to special amplifiers via CAT7 cables, see Figure 2.5.



**Figure 2.5: FT12TPhex plug with square case**

When the FT12TP(hex) plug is connected to the delay-line it is possible verifying the absence of shorts between signal and reference wires or some of the possible cabling errors on the vacuum side of the feedthrough: The resistance between  $U_{ref}$  and

\* In case you have an older **FT12TP** plug for use with **DLD** with 6 lemo sockets (and 6 SHV connectors) please refer to the manual that came with this delivery or ask **RoentDek** for a manual of old-type **FT12TP** assemblies.

$U_{sig}$  SHV inputs should exceed  $10M\Omega$ . A resistance value on the order of  $1-2M\Omega$  or less indicates a cabling error or a short on the delay line. Please note that some other possible misconnections on the feedthrough may not be found by this test.

Likewise, the presence of shorts between other parts of the detector or from parts to ground will be revealed by a  $<10M\Omega$  "short" if measured through the SHV inputs of the decoupler circuits (assuming that all connections are in place). Exception: between properly connected MCP front and MCP back input one can measure a resistance on the order of the expected MCP stack resistance which may be  $<10M\Omega$  in some cases, especially when the detector is still exposed to ambient air. In case of the **FT12TPhex** please also refer to the next section for this test.

With the help of a fast signal pulse generator (e.g. the **RoentDek** APG1) one can send a signal via an (output) lemo connector (e.g. x1) of the **FT12TP(hex)** through a delay-line layer and verify the (delayed and slightly damped/distorted) response signal from the (x2) output with an oscilloscope (see figure 2.6, the same check can be done for the other layers). Most wiring errors will be revealed by a strongly distorted signal response.

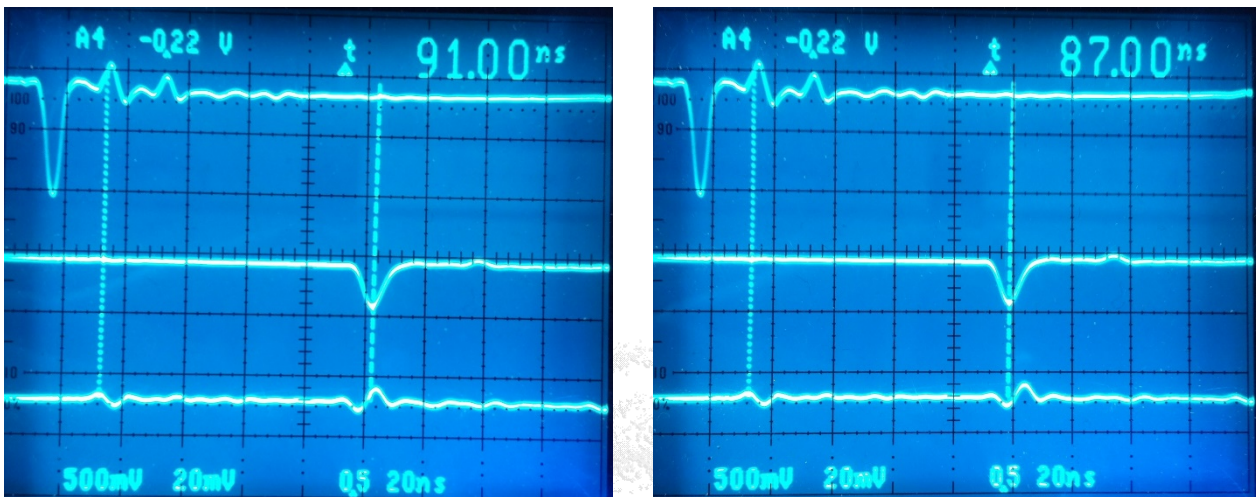


Figure 2.6: Response of a delay-line to a signal passing through a **FT12TP(hex)** plug. Upper trace: input signal, middle trace: output signal from the opposing terminal of the same layer, lower trace: output from a terminal of another layer (25x enlarged). The left marker defines the input time reference. Further explanations see text.

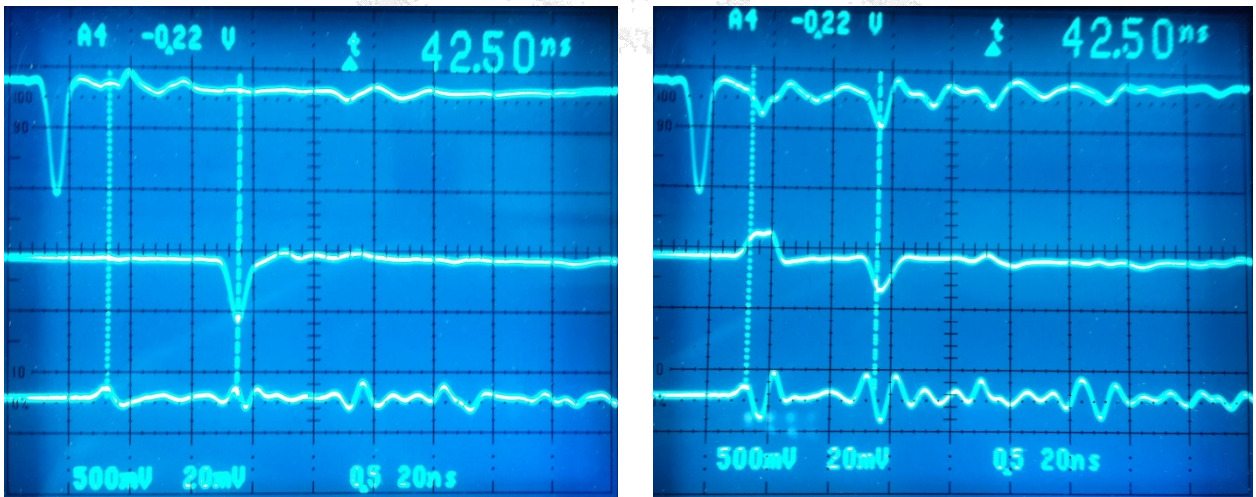


Figure 2.6 shows in the upper two images signals transmitted through the **DLD80** anode layers via the **FT12TP** connector (left picture: outer layer, i.e. via  $x_1/x_2$ , and inner layer on right picture). A correctly connected anode will show a slightly damped output signal response (middle trace), delayed according to the delay-line transmission time (plus offset from connection cables). The cross talk to another layer (lower trace) is small. The lower left image shows the same for a **DLD40**. If the connections between pin 6 and 8 are swapped as in the right lower picture the response is clearly different.

**Blocking resistors:**



An integral part of most signal decoupling circuits is a serial resistor in the connection line between the MCP stack and the bias input, e.g. from the high voltage supply. The resistor forms a chain with the MCP stack resistance (and more resistors in the line, e.g. a serial resistor on the other MCP stack side) and alters the effective potential present on the MCP surface: it is shifted by a value  $\Delta U$  towards the potential on the other MCP side, compared to the set potential coming from the high voltage supply. These serial resistors are usually small compared to the MCP resistance but the effect cannot always be neglected.

$$dU_{MCP\ front} = \Delta U_{MCP} \times \frac{R_{Df}}{R_{MCP} + (R_{Db} + R_{Df})}$$

Equation 2.1

$$dU_{MCP\ back} = \Delta U_{MCP} \times \frac{R_{Db}}{R_{MCP} + (R_{Db} + R_{Df})}$$

$dU_{MCP\ front/back}$  are the potential shifts between set and effective potential on the MCP stack ends,  $R_{MCP}$  is the MCP stack resistance and  $R_{Df}/R_{Db}$  the serial resistors' values in the respective decoupling circuits and  $\Delta U_{MCP}$  is the set voltage difference across the MCP ( $\Delta U_{MCP} = U_{MCP\ back} - U_{MCP\ front}$ ). Usually, the term  $(R_{Df} + R_{Db})$  can be neglected in the denominator of the equations.

Example:  $R_{MCP} = 60\ M\Omega$ ,  $R_{Df} = 10\ k\Omega$ ,  $R_{Db} = 1\ M\Omega$ ,  $U_{MCP\ front} = -600\ V$ ,  $U_{MCP\ back} = +1800\ V$   
 $\rightarrow U_{MCP\ front\ effective} = -599.6\ V$ ,  $U_{MCP\ back\ effective} = +1760\ V$ ,  $\Delta U_{MCP\ effective} = 2360\ V$

In the **FT12TP** decoupler  $R_{Df}$  and  $R_{Db}$  are  $10\ k\Omega$  and  $1\ M\Omega$ , respectively, older **FT12TP** plugs may have  $1\ M\Omega$  as default value for both sides, also like the standard **RoentDek FT4TP** with **HFSD** and **HFST** single line decouplers (see next section). It is possible to measure the actual resistance values with an Ohm meter between the high voltage input socket and the pin that connects to the respective feedthrough. The sum  $(R_{MCP} + R_{Df} + R_{Db})$  can also be measured through the decoupler's high voltage inputs for  $U_{back}$  and  $U_{front}$  if all connections to the MCP are made. Note that the measured value  $R_{MCP}$  can differ compared to operation conditions if the stack is at atmospheric pressure.  $R_{MCP}$  is also temperature dependent.

**Attention:** *Although the outputs of the FT4TP and FT12TP are delivered with DC-coupling to ground potential, a discharge on a detector can damage the electronics which is used to analyze or amplify the signals.*

**Before vacuum-baking of the experimental setup all air-side connections on the FT12 and FT4 feedthroughs must be removed. The FT12TP plugs and HFSD/T connectors are not rated for typical bake-out temperatures**

## 2.4 The FT4(TP) for FT16(TP) and DET40/75

For the **RoentDek HEX** detector and the timing detectors of type **DET40/75** the **FT4**, a four-fold MHV feedthrough set (optionally SHV) on CF35 flange is used to supply cable contacts to MCP front, MCP back, Holder (or the timing anode, respectively) and an optional mesh. For signal pickup or termination, individual **HF-signal-de-coupler plugs (HFSD/HFST)** (Figure 2.7) for each detector contact can be provided to complete the product set **FT4TP**. This combines with the **FT12TPhex** to the **FT16TP**. The **HF-signal-de-coupler plug** for the Hexanode "Holder" is of type **HFST** and has a signal terminating poti. The same type is used on one of the MCP contacts, while the other MCP contact (and the timing anode contact, respectively) is supplied via a **HFSD** signal decoupler with a lemo output socket for the signal to further process it to an amplifier and timing circuit. An **Adjustable LEMO Terminator (AST)** can be optionally supplied to turn a **HFSD** into a double-use unit (as **HFSD** or **HFST**). The latest version of the **HFSD** has a poti in the signal line (see red arrow in Figure 2.7) which can also be used to improve the signal quality in combination with the other potis (like with the **FT12TP** connector plug and **DLD**)\*. Optionally, the **HFSD** and **HFST** can be supplied with a  $10\ k\Omega$  serial resistor in the line to the high voltage power supply (default is  $1\ M\Omega$ ).

\* On older systems the **HFSD** needs to be opened for accessing the in-line poti. Although most care has been taken to insulate all high voltage holding parts of the circuit for your safety please be careful to **only touch the poti screw** and **only with an insulating screw driver** when operating on an open **HFSD**.

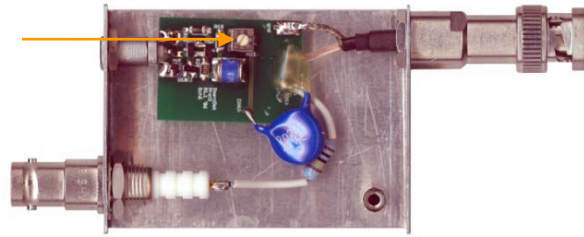


Figure 2.7: Single HF-signal-de-coupler plug (HFSD) with LEMO output and in-line poti

The *HF-signal-de-coupler plugs* can also contain an additional resistor to ground which provides the **HVT** function (see **RoentDek** power supply manual which may be appended to this document).

## 2.5 Operation of the MCP detector with delay-line (or timing) anode

This introduction to the MCP detector operation shall only give general info on the detector startup and basic function verification. For fine-tuning please refer to the specific sections describing the front end electronics (amplifier and timing circuits), digital read-out and high voltage supply, e.g. as optionally available from **RoentDek**.

If you have purchased a detector for operation at higher voltages than 4kV please refer to the separate manual.

### 2.5.1 Initial Startup Procedure

After installation of the detector and verification of all connections it is advisable to verify the absence of electronic noise on the detector parts, i.e. on the MCP front/back and anode contacts. Continuous noise should be  $<1\text{mV}$  peak-to-peak. Noise should be checked by connecting an amplifier (band width about 100MHz or higher) to the outputs of the signal decouplers (high voltage supplies turned off) and verifying the amplified output on an oscilloscope (taking into account the amplification factor to judge the noise amplitude). If you should find a too-high noise level (or no noise at all) this may indicate erroneous cable connections. External sources for noise may be found in the lab equipment and can be traced by turning off lab equipment sequentially, or outside the lab/building (power stations, heavy machinery operating, radio stations ...).

This test can already be done before starting the vacuum pumps which may also contribute to the noise level.

For supplying the MCP operation voltages it is strongly recommended to use low-ripple power supplies with current limitation and fast shutdown for protection (as available from **RoentDek**).

Always evacuate the vacuum chamber slowly (50mbar/sec) in the presence of an MCP detector. The maximum recommended operating pressure for the detector is  $2 \times 10^{-6}$  mbar).

Before applying any voltage to the detector for the first time it should be verified that:

- the detector is in appropriate vacuum conditions ( $< 10^{-6}$  Torr) for at least 24h, see also Appendix
- all connections inside the vacuum are complete and have been carefully verified, also for absence of shorts
- safe distances are kept or sound insulation is installed between all biased parts of the detector (including attached cables) and the chamber wall and or other metal parts on ground or other potentials (i.e. mounting gear)
- safe distances are kept between the MCP front (and optional mesh) contacts and exposed cable parts to any other part of the detector (double-check also exposed cable/connector parts on the vacuum feedthrough)
- all feedthroughs, decoupling circuits and high voltage cables are rated for the targeted maximum detector voltage,
- potential EM noise sources are turned off
- UV sources, high power laser sources, charged particle sources (also ion gauges or ion pumps, discharge gaps) in the detector's vacuum recipient are turned off

New MCP or MCP that have been exposed to atmospheric pressure for a long time must be biased very slowly in steps of 100V every few minutes. During this, the current should be monitored for possible deviations from linear current-to-voltage characteristics (indicating a problem). As the operation voltage is approached, the amount of "dark counts" (MCP signals in absence of any particle/photon source) should be monitored. This requires a low noise level (see above). To monitor the noise and the presence of signals, an amplifier should be used for verifying signals from the MCP front or MCP back contact with an oscilloscope. A low dark count rate (typically  $<100$  counts/sec, randomly distributed) will at some point already indicate that the MCP is operating normally, especially when the mean pulse height increases/decreases according to the MCP bias setting.

A spontaneous discharge or a significantly higher dark count rate indicates a problem such as a glow discharge or the presence of charged particles/photons triggering the MCP. If this rate is excessive the MCP can be damaged. In such an event turn off the high voltage and verify your setup again. Note that it may occur that an excessive load of particles on the MCP detector is not detected by verifying the MCP signal because the MCP stack reaches current saturation before producing individual pulses of detectable signal height (i.e. above noise level). Such MCP saturation can usually be recognized from non-linear bias/current characteristics. Therefore we recommend using high voltage supplies with current reading, as available from **RoentDek**. Note, that some high voltage supplies may also increase the noise level, especially at high bias.

It is recommended to initially operate the detector in the so-called “ion mode” as used for detecting slow (and light) positive ions or fast (neutral) particles and photons, having MCP back at zero voltage to ground and the anode bias on few hundred Volts positive potential. At such potential discharge events on the “rear part” of the detector are virtually excluded. Only the MCP front side is at high negative potential and the risk for discharge (malfunction) from preparation mistakes is lowest. Remaining hazards are too-close metal parts in front of the MCP front face or at the cable contacts: nearby cable contacts should either be at least 3mm away or biased with the same potential for avoiding “sparks” (spontaneous discharges) and glow discharges which can occur from pointy parts already at relative potential well below the critical limit for spontaneous discharge.

Typical voltage settings are

	Ion or Photon Detection	Electron Detection
MCP front	-2400V	+300V
MCP back	0V	+2700V
Delay-line anode holder	0V to 250V	+2700V to +2950V
Reference wires (respectively timing anode)	+250V	+2950V
Collecting (Signal) wires	+300V	+3000V

**Table 2.3: Typical detector voltage settings (chevron sets of 60:1 MCP). The (delay-line anode) “holder” potential needs to be carefully adjusted later to achieve optimal linear imaging performance at outer detection diameters**

While increasing MCP front bias in ion mode with negative polarity in steps of 100V every few minutes the MCP current should be recorded. If you use a high voltage supply from **RoentDek** turn on the “kill” option so that the voltage is turned off in case of unexpected current peaking (i.e. a discharge, see also the respective manual). It is also recommended to reduce the maximum current limit to the lowest setting just above the expected default current, usually <0.3mA (other high voltage supplies may have similar safety features which should be engaged). It is recommended disconnecting the signal cables leading to amplifiers or other sensitive equipment (like the oscilloscope) until you have reached about 70%- 80% of the default MCP bias (as recommended for normal operation, see below). Otherwise there is a risk of damaging follow-up electronics in case of an unexpected discharge event.

Make sure that the MCP back side remains on or near ground potential while increasing the potential on MCP front. If you use high voltage power supplies from **RoentDek** to bias MCP back, switch off this channel (like most high voltage supplies it may otherwise be “drawn away”, see below). Or connect a **RoentDek** HVT or SHV-G (ground plug) to the MCP back high voltage input on the decoupler instead.

As you increase the MCP front voltage calculate the MCP stack resistance from the current reading for each voltage step.

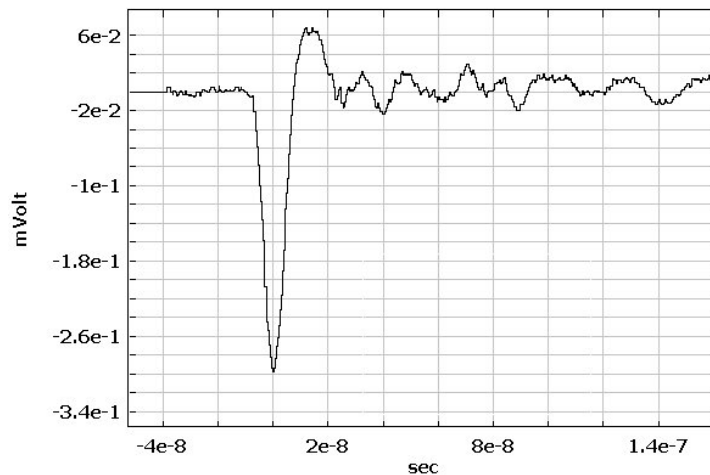
**The MCP stack resistance should stay constant as the voltage is increased.**

Typical MCP stack resistance values are between 10MΩ and several 100MΩ. You may have received info on the default MCP resistance to compare it with your reading\*. Deviation from strict MCP resistance constancy can arise from temperature effects: For a 1°K increase in temperature the resistance drops by about 1%. Note, that the MCP stack can be heated up from the strip current, i.e. the resistance at high current (voltage) may be lower than at low current (voltage). In-line decoupler resistors or an (undetected) minor “voltage pull-up” of the high voltage supply for MCP back may also lead to small deviations between measured and real MCP resistance. If you use a **RoentDek** HVZ module at this point there will apparently be a strong non-linear response below 300V MCP bias. In this case please refer to the respective manual.

\* Note that specific resistance values given by the MCP producers may not be accurate, systematic deviations by a factor of 2 can occur. However, MCPs specified to be of same resistance will always form a matched stack.

Once you have reached about 70% - 80% of the default MCP stack bias you can start observing dark counts (and potentially counts from particles) with low pulse height (10mV, positive polarity, few ns width). From now on the signal from MCP back should be verified on an oscilloscope. **Unless your decoupling circuit's signal output is internally DC-terminated** (the **RoentDek** decouplers are) you must turn down the voltage before connecting a cable for signal verification. **Otherwise a discharge may occur and potentially damage the detector and/or the follow-up electronics.** (If you had to turn down the voltage you can steadily increase the voltage again with a ramp speed of up to 1000V per second to the value which was reached before).

**One should never connect an oscilloscope directly to the signal output of a decoupler because a discharge may damage it.** Instead one should route the signal through an amplifier. The amplifier input may also be destroyed by a discharge but it is usually easier to repair. **RoentDek** decoupling circuits and amplifier inputs contain several safety circuits (and are more robust than most other circuits), especially when used in combination. However, they may be damaged in some cases, too. A repair procedure and costs are well defined, please contact **RoentDek** in such an event.



**Figure 2.8: Typical amplified pulse shape from the MCP after processing with an inverting amplifier (here: analog monitor output from a **RoentDek** ATR19 module).**

If you will observe dark counts at a decent rate you may further increase the voltage in steps and watch their growing pulse height with each step until you reach the default voltage. Generally, MCP stacks can be operated with a relative bias voltage up to about 1300V for each MCP in the stack for MCP with L/D 60:1 or 80:1 (only 1000V per MCP with L/D of 40:1, for 80:1 even higher bias up to 1500V per MCP may be required). Applying lower bias on the MCP often yields sufficient performance and can increase the lifetime of the MCP stack. Higher voltages are not recommended and will only improve the performance if the amplifiers still have sufficient dynamics.

At this point one should also connect the delay-line anode (or timing anode) signal output(s) to amplifiers (see safety consideration above before that) and verify all signals on the oscilloscope. Signals from the delay-line or timing anode look similar like MCP signals but have negative polarity. If anode signals should be “missing” or noisy please verify their connections. You may be required to vent the vacuum chamber and open it for that. However, most wiring errors can be found by verifying connections with an Ohm meter or passing a test pulse from an external source (e.g. the **RoentDek** APG1) through the delay-line layers.

**Always make sure to turn high voltage off before venting the chamber.**

Even if you have vented the chamber only for a short time you should allow at least 8 hours of pumping at sufficient pressure level. You may raise the voltage on the MCP up to the level that was reached once before in much shorter time (100V/sec), however, be aware of the risk for discharge events after the detector or the cables have been touched or moved. Verify all signals until the detector operates normally.

### 2.5.2 General Operation

Depending on the particle species to be detected you will have to shift all detector voltages with respect to ground, maintaining the relative detector potentials at about the same levels.



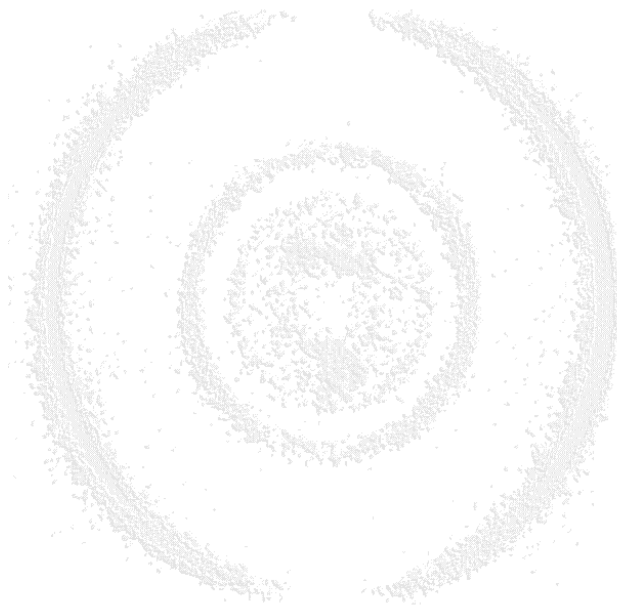
The optimal potential of the MCP front side with respect to ground depends on the particles to be detected. Ions should be pre-accelerated onto the detector with a potential of -2000V or higher. For most ion species it is suitable to operate the MCP back side on or near ground potential, thus the front side is in the range of -2kV to -3kV (ion mode). Electrons should be accelerated to at least 200eV to ensure high detection efficiency. Thus the MCP front should be around +200V or higher with respect to the electron source for low energetic electrons (electron mode). For UV photon detection or fast particles with >10keV/u the MCP front side potential is arbitrary.

If you want to operate the detector at different bias than the now verified “ion mode” you may simply change your voltage settings accordingly. It is important to never exceed relative voltages of 100V between the reference and signal wire and of 500V between holder and signal wires or holder (respectively the timing anode) and MCP back. Otherwise discharges can occur and damage the detector and electronics.

Before applying different voltage settings for the first time or after manipulating on the detector hardware / in-vacuum cables in some way you have to make sure that these voltages (e.g. high potential with respect to ground on MCP back and the anode contacts) can be safely set without discharge occurring. You should slowly increase the voltage towards the target values and observe MCP back/front signal and the MCP resistance carefully during this procedure, as in described for the initial startup procedure. It is advisable that all voltages for the anode and MCP back are drawn from only one (or as few as possible) high voltage supply channels by using a voltage dividing scheme (e.g. with the **RoentDek HVZ** and/or **BA3**).

Again you must verify that set voltages on high voltage supplies for MCP back and MCP front are maintained which is sometimes not the case, especially when biased with the same polarity. Also **RoentDek** modules show this effect and need an additional terminating resistor (as in the **HVT**, see separate manual).

For achieving optimal results it is now necessary optimizing MCP gain and amplifier gain for the follow-up timing electronics. You should refer to the specific manuals. Generally it is advisable to operate at a high MCP gain because only this ensures optimal signal-to-noise ratio. Although it is also possible to increase the signal height by increasing the amplifier gain, it will also increase the noise level. Therefore it is better to operate at a moderately high MCP gain, i.e. where the MCP stack can still produce a decent pulse height distribution and no excessive after-pulses (ion-feedback). However, there are reasons to operate at lower MCP gain (and compromise on position and time resolution) if the highest MCP signals in the distribution saturate the amplifier (at its lowest gain setting), if ion feedback must be reduced (e.g. for multi-hit applications) or if MCP life-time is an issue (i.e. for very high particle flux).



### 3 The Front-end timing electronics modules: Amplifier & CFD Module

**RoentDek** offers different versions of front-end timing electronics.

This manual contains the **ATR19** description. If you have received different front-end electronics please refer to separate manual(s) which shall replace the following section

This is (Version 11.0.1303.1). Please look for updates of this manual at

<http://roentdek.com/manuals/>

The readout of the MCP and delay-line anode signals requires amplifying and precise timing (discrimination) circuits such as “Constant-Fraction Discriminators” (CFD). Those produce digital signals (like NIM or ECL) for a follow-up time measuring device, e.g. a time-to-digital converter (TDC).

The **ATR19** module was especially designed for this timing detector read out purpose. In the version as 1 HU 19” case with internal mains power supply it can host up to four **DLATR** differential timing amplifier & CFD boards, each with two independent channels. It provides all input/output connectors, level controls and a 100-125V/200-250V AC power adapter. The module is typically delivered either with 3 boards (**ATR19-6**, 6 channels total), for use with the **DLD** detectors or with all slots occupied (**ATR19-8**, 8 channels total) e.g. for use with **Hex**-detectors\*. Each version can either provide the timing signals as NIM or differential ECL level, e.g. depending on the requirements of the time measuring device.

The **ATR19-2b** module version as 4 HU cassette hosts only one card and contains the same input/output options as the larger unit and comes with an external mains adapter. The older **ATR19-2** model requires a mains power adapter with  $\pm 6V (<0.5A)$  for operation, such as **SPS1(b)**. Its circuits are similar to the internal supply in the **ATR19-6/8** and can also be used as a back-up external mains adapter for those units, and also for earlier (**N**)**DLATR6/8** models, see Chapter 3.8.

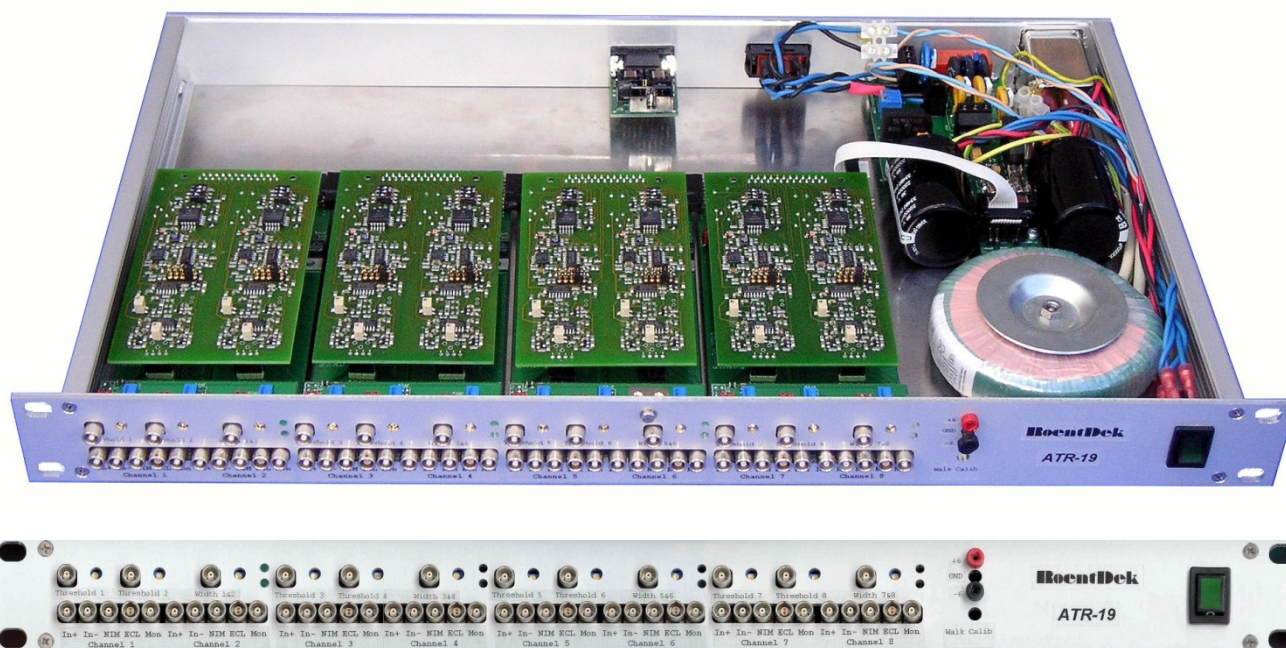


Figure 3.1: The ATR19 module

The differential amplifying stage of the internal **DLATR**-board has 200MHz band width with 100Ω input impedance, DC coupled. However, the **ATR19** in the standard version contains capacitors for AC-coupling of the inputs.

The **ATR19** is usually operated as a non-symmetric (single input) amplifier with 50Ω impedance to ground, inverting (-) or non-inverting (+). This non-symmetric operation is the default mode for the use of a delay-line detector in combination with the (standard) **FT4/12/16TP** feedthrough and decoupling plugs.

The outputs of the **ATR19** allow verification of the signals after the first amplification stage on the **DLATR** board (“analog” signal) and of the NIM or ECL timing output signals. Amplification, trigger threshold and timing signal width can be adjusted by potentiometers (default) or externally by DC levels (0 to +5V), the CFD “walk” adjust is automated (push-button) or pre-

\* However, a **FAMP8+CFD8** type combination is recommended with the Hexanode for improved multi-hit performance.

set (with **DLATR2.0**). Double-hit dead-time of the CFD-outputs is about 20ns, depending on the input signal width. Since the amplifier inputs are internally not tolerant to both signal polarities (no bipolar amplification), it is required to feed signals into the inputs of corresponding polarity. Therefore positive input signals (e.g. the signal from the MCP) must be connected via the inverting (-) input and negative signals must be connected via the non-inverting (+) input. To ensure proper input impedance of single polarity signals the other input of the internal amplifier should be terminated to ground (see Chapter 3.1).

The recommended readout version of the **RoentDek** delay-line detectors involves the **FT12(16)-TP** plug with internal signal transformers for the delay-line signals. For applications where only the single particle timing is of importance (e.g. with **DET40/75**) a **FT4TP**-type read-out in combination with the **ATR19-2** is recommended. The physical characteristics of the **ATR19-2** are described in Chapter 3.6.

When the **ATR19** is delivered, channel 1 and 2 are by default prepared for positive input polarity (inverting) and the other channels (used for the delay-line signals) for negative (non-inverting) signal polarity. (**ATR19-2** default: ch1 for positive input polarity (inverting) and ch2 for negative (non-inverting) signal polarity). If the voltages to the detector are supplied in the recommended way the signal from the MCP front or back contact (positive) has to be connected to ch1- or ch2- and the delay-line signals to ch3+ to ch6+ (or ch8+). In case of **DET40** and **ATR19-2**: the signal from the MCP front or back contact (positive) has to be connected to ch1- and/or the signal from the timing anode (negative) has to be connected to ch2. Changing these settings requires to open the **ATR19** module (see Chapter 3.5 and for **ATR19-2** also Chapter 3.6).

### 3.1 Signal inputs and amplification

The **ATR19** hosts three or four **DLATR** boards (one in case of **ATR19-2**). Each board has two independent channels for amplification and timing discrimination. Each differential amplifying stage has 100 $\Omega$  impedance (2x50 $\Omega$  to ground) and a selectable differential amplification gain between 20 and 100. The gain can be adjusted by a potentiometer (“poti”) on each board and channel independently through holes in the top lid of the **ATR19** module.



**Figure 3.2: Top lid of ATR19 with holes to reach the gain potentiometers.  
Turning clockwise: amplifier gain is increased, turning counter clockwise: gain is decreased  
(for ATR19-2 refer to Chapter 3.6)**

The input to each amplifier is provided AC-coupled via coaxial LEMO connectors with 50 $\Omega$  impedance. It is important to note the actual input settings for each individual channel inside the **ATR19**, i.e. the position of the termination jumpers JP5, JP6 (odd channel numbers of the ATR front panel) JP8 and JP9 (even channel numbers):



- a) no jumpers: inputs + and – are active (differential) with 100Ω impedance. Please observe the polarity
- b) jumper on JP6/JP9: input – (inverting 50Ω impedance to ground); can be used for positive input signals
- c) jumper on JP5/JP8: input + (non-inverting 50Ω impedance to ground); can be used for negative input signals

Default settings are: ch1 and ch2 as (b) and ch3 to ch8 as (c), for **ATR19-2**: ch1 as (b) and ch2 as (c) when used with a **DET40/75** or both channels as (c) for read-out of a delay-line anode.

If you want to change these settings please refer to chapter 3.5 and/or 3.6.

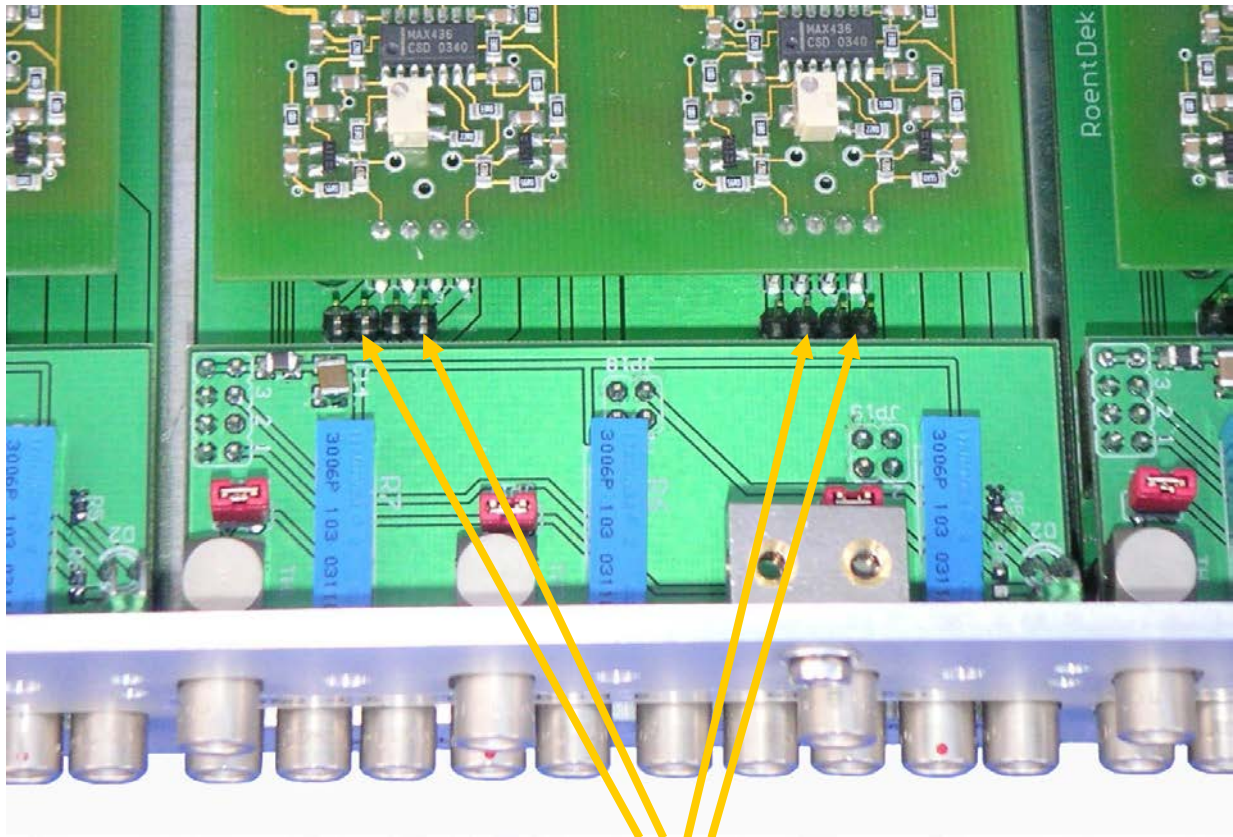


Figure 3.3: ATR19 with input settings for differential input (no input jumpers set)

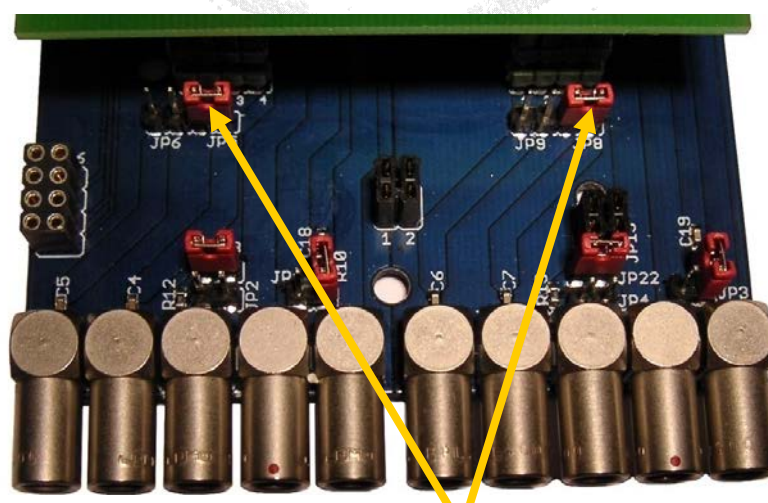


Figure 3.4: ATR19 base board with input jumper settings for signal input through the “+” LEMO input (50Ω impedance to ground, non-inverting, for negative signal input). The level control board was removed here for better view.



### 3.2 The DLATR board

The **ATR19** module contains boards of type **DLATR**, which are occasionally updated in the circuit design without altering their function. Currently **DLATR+** and **DLATR2.0** boards are supplied. The board can easily be exchanged. To modify settings on the boards or exchange the boards please refer to Chapter 3.5. The amplification gain can be changed without opening the **ATR19** unit.

These 3 switches for each channel define the output level NIM or ECL (number 3 must always be „off“)

- 1: „on“ ECL, „off“ NIM
- 2: „on“ ECL, „off“ NIM

The marked potis, see purple arrows (2kΩ for the **DLATR+**) adjust the amplification.

Higher resistance corresponds to lower amplification (not linear).

The marked jumpers, see blue arrows, define the internal CFD-delay. The figure shows the default position (8ns for **DLATR** and 6ns for **DLATR+**). From bottom to top: 2,4,6,8,10ns

For **DLATR2.0**: the red arrows mark the walk potis and the test points (factory set to 12-14mV)

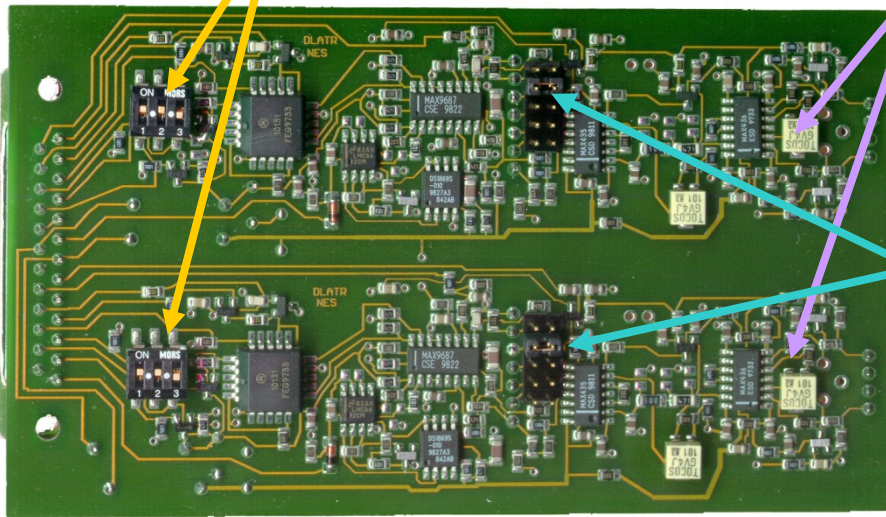


Figure 3.5: DLATR amplifier and constant fraction discriminator boards.

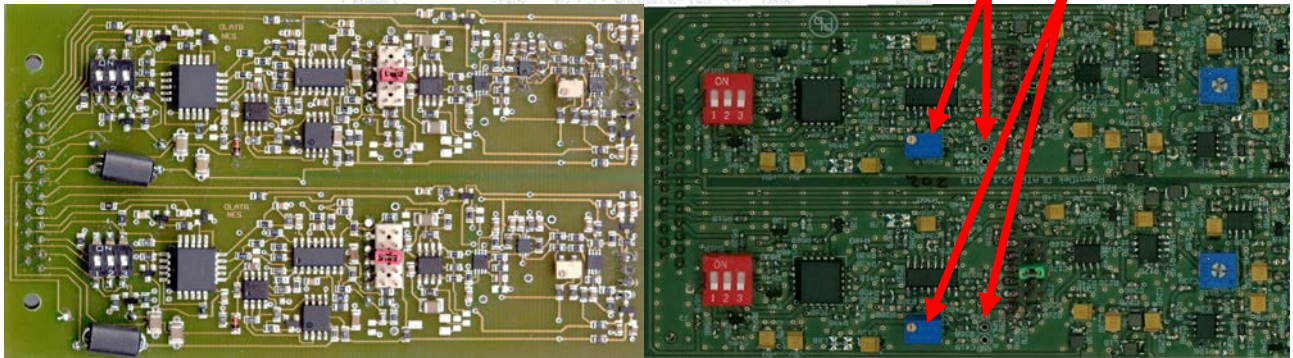


Figure 3.6: DLATR+ version (left) and DLATR2.0 (right)

If you insert a board make sure that the settings on the board are according to the requirements (e.g. signal level NIM or ECL). The switches have to be set according to the desired timing signals levels from the **ATR19** module.

*Always switch off the power when inserting or retracting a DLATR board or changing settings on a board.*

### 3.3 CFD controls and outputs

The **ATR19** has the following inputs, outputs and controls for each channel:

2 LEMO connectors In+ and In- for signal input (see Chapter 3.1)

3 LEMO connectors for signal outputs:

Mon analog output signal, i.e. the amplified signal before the CFD-stage.

- ECL Timing signal output from the CFD circuit (differential ECL).  
Only for the ECL version of the **ATR19**
- NIM For the NIM version of the **ATR19**: NIM timing signal output from the CFD circuit.  
For the ECL version of the **ATR19**: modified ECL- signal level from the CFD circuit for threshold control
- 2 LEMO connectors and pots for CFD threshold control
- 1 LEMO connector and poti for signal width control (for both channels of the same **DLATR** board)
- 2 LED for power verification of +5.2V/-5.2V for each **DLATR** board

Additionally there is a push button for the walk calibration of all channels, a power switch and reading points for the internal DC voltage supply to all boards on the **ATR19** front panel. The rear panel hosts the mains power input and selection switch (100-125V or 200-250V AC) and an alternative DC power input. Please refer to Chapter 3.5 if you want to use the DC power input.

Holes in the **ATR19** top lid allow access to the amplification gain pots of each channel.



**Figure 3.7: inputs, outputs and controls of the ATR19 for each internal DLATR board**

The “Mon” output allows a monitoring of the noise level and the signal quality from the delay-line. This output shows the amplified signal according to the input signal and input settings (jumpers JP5, JP6, JP8 and JP9, see Chapter 3.1). For verifying the signal, the input of the oscilloscope must be 50Ω coupled and the CFD output (ECL or NIM) should be connected to the TDC.

The “ECL” output (only for ECL version of the **ATR19**) provides the timing signal (differential ECL) from the CFD circuit for use with a TDC of according input requirement. The TDC input should provide -2V via 50Ω or form a similar passive differential ECL input.

The “NIM” output provides

- for NIM version of the **ATR19**: the timing signal (standard NIM signal) from the CFD circuit for use with a TDC of according input requirement.  
The signal can be verified on an oscilloscope (50Ω coupling).
- for ECL version of the **ATR19**: the modified timing signal from the CFD circuit (ECL -) for monitoring via an Oscilloscope: select AC coupling with large impedance (e.g. 1MΩ)

The CFD circuit requires the setting of a threshold in order to discriminate noise from real signals. This threshold is set by a DC level of 0 to +5V. This level can be set and controlled internally via the threshold poti for each channel (default) or by directly supplying this voltage through the corresponding LEMO input. A jumper (JP11 and JP12) on the level control board inside the **ATR19** (see Chapter 3.5) enables the threshold control by the poti (default setting). In this mode (jumper JP11/JP12 set) the LEMO output carries the DC voltage for control with an Ohm meter. If the jumper is removed the poti is disabled and the LEMO connector serves as input for the DC voltage from an external source. Please contact **RoentDek** for adequate remote DC level controls (e.g. the **USB-I/O** modules).

A DC voltage of +5V corresponds to a threshold level of -100mV on the amplified signal (as obtained from the “Mon” output). The ratio between DC voltage on the LEMO connector and the threshold is -50. Note that in case of **DLATR+** and **DLATR2.0** the pulse height indicated on the “Mon” output is only half of the real pulse height.

The width of the timing signal from the CFD is set by another DC voltage (0 to +5V) which can likewise either be supplied by the corresponding poti and probed via the LEMO connector (JP13 set, default) or by directly supplying this DC voltage (JP13 off). Thus the width can be adjusted between 10 and about 100ns. Note that there is only one control for both channels on each **DLATR** board.

If the LEDs next to each **DLATR** in-/output connector group (on the right side) is not lit please verify the DC voltages on the reading points near the power switch on the front panel. If these are present and within the specified range (see Chapter 3.4) refer to Chapter 3.5 (opening the **ATR19**) and insure that the corresponding board is properly installed.

If the DC voltages on the reading points near the power switch on the front panel are not within specification verify the mains power or the external DC supply (see Chapter 3.4)

Before starting a measurement the “walk” of the CFD on all boards can be adjusted. This is generally not necessary and in case of the **DLATR2.0** the walk level is factory-set and the walk adjust button is disabled.

If you want to calibrate the walk (for all other boards) at the beginning of a measurement please follow these steps:

Switch off the high voltage on the detector

Verify that the noise level is low and that there are no signals from the CFD outputs.

Press the walk button for at least 1 second.

Wait at least 15s for the automatic walk adjust

Then apply voltage to the detector and start/resume your measurement

### 3.4 Connecting and operating the ATR19

Before connecting the **ATR19** to any cable please ensure that the AC mains power from your socket complies with the setting of the switch on the rear panel (not for **ATR19-2**).

The setting “230” complies with a mains power of 200-250V AC, 50-60Hz, main fuse: 250mA, time lag

The setting “115” complies with a mains power of 100-125V AC, 50-60Hz, main fuse: 500mA or 630mA, time lag

#### **Warning: A wrong setting can lead to damage of the ATR19 and/or any connected appliances**

After connecting the mains power through the standard mains cable input on the rear panel turn on the module with the switch on the front panel. Please verify that the DC voltages on the reading points on the front panel are between 5.5V and 6.5V - positive and negative - and that all LEDs are lit. If the DC voltages are not present please check the mains voltage and the main fuse in the mains connector, replace the fuse if necessary. The main fuse is located above the mains input socket (see Chapter 3.9, not for **ATR19-2**).

If the main fuse, the switch position and the main power seem to be ok, please follow the steps in Chapter 3.5 for opening the **ATR19** and verify the separate fuses for positive DC (1.6A, swift) and negative DC (2.5A, swift), replace fuses if necessary. The fuses are located on the voltage adapter board (see also Chapter 3.9, not for **ATR19-2**).

If you want to use the external  $\pm 6V$  DC input (default for **ATR19-2**) instead of an internal mains power adapter please follow the steps in Chapter 3.5 for opening the **ATR19** and remove the internal cable connector from the mains adapter to the external input. If you have ordered the **ATR19** for use without AC mains adapter (e.g. **ATR19-2**), the cable is already connected in the correct way. For operating the **ATR19** DC voltages -6V on pin 5 and +6V on pin 8 (2A each) are required, pin 1 and 2 must be grounded.\*

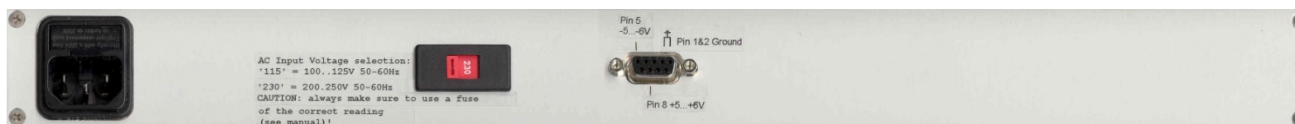
The **ATR19** can also be supplied externally with  $\pm 5.2V$  (or  $\pm 5V$ ) via the same connector. In this case the jumpers JP7 and JP10 (located under each **DLATR** board) have to be removed.

**Attention:** A few of the earliest **ATR19**, which have been delivered to customers, allow an external DC supply only with  $\pm 5.2V$  (JP7 and JP10 removed). If in doubt please contact **RoentDek** to insure that your module can also be operated with  $\pm 6V$  and JP7 and JP10 set.

---

\* Adequate DC supply and cabling can be achieved from the **SPS1(b)** modules with a corresponding cable.





**Figure 3.8: Rear panel of the ATR19 (for ATR19-2 see Chapter 3.6)**

Before connecting the input cables to the LEMO connectors on the **ATR19** front panel make sure that the detector voltages are switched off and that you are aware of the input jumper settings for the respective channels and the active input connectors (see Chapter 3.1).

In the default versions of the **ATR19** (not **ATR19-2**) ch1 and ch2 (inverting) are reserved for the (positive) MCP signal input via the “In-” LEMO connector, while the other channels are non-inverting for signals from the delay line ends which shall be supplied through the “In+” LEMO connectors. The delay-line signals are negative if the  $U_{ref}$  and  $U_{sig}$  voltages are provided to the corresponding connectors on **FT12(16)-TP** as described in the detector manual. If these voltage inputs are interchanged, the signals from the delay-line will become positive and require connection via the “In-“ inputs and changing the input jumpers inside the **ATR19** from their default settings (see Chapter 3.1).

In case of **DET40/75** and **ATR19-2(b)**: the signal from the MCP front or back contact (positive) has to be connected to ch1 In- and/or the signal from the timing anode (negative) has to be connected to ch2 In+.

Now you may also connect the “Mon”, “ECL” and “NIM” outputs for signal verification and/or data acquisition with a TDC, depending on the **ATR19** version that you have obtained (see also Chapter 3.1).

If you operate the threshold and width controls of the **DLATR** boards via the potis (JP11, JP12, JP13 set) you may now connect the threshold and width LEMO connectors to an Ohm-meter for verification.

If you operate the threshold and/or signal width DC levels with external voltages (JP11, JP12, JP13 off) you must now connect the corresponding LEMO inputs. Before you can obtain output signals from the CFD output (ECL and/or NIM) these voltages must be set from your external DC source. The default values are 2V and have to be finally adjusted during detector operation.

## 3.5 Opening the ATR19 module

You need to open the lid of the **ATR19** module **only** if

- you want to change the input impedance or inversion of an amplifier channel
- exchange a **DLATR** board
- switch between mains power supply to external DC power
- change the setting method for CFD signal width or threshold levels
- modify the CFD output level (ECL or NIM)

To open the top lid please follow these steps and for **ATR19-2** refer also to Chapter 3.6:

### I. **ATR19-6/8-channel version:**

**Switch off the ATR19 main power and retract any cables from the module.**

Remove the 4 screws on the rear panel and the two screws on the top lid. Now the back panel is not fixed anymore to the rest of the housing but connectors in the rear panel are still wired to the main AC adapter board inside the **ATR19**.

Without pulling too much on the cables it is possible to retract the rear panel carefully for about 2 cm. Now the top lid can be retracted from its guide slots.

Retract the top lid

Fix the rear panel to the housing again. It is sufficient to fix the rear panel only provisionally by a couple of screws. When reinserting the screws make sure that they are entering the thread correctly.

**Warning:** when the lid is open you should not connect the mains cable to the socket. There is a severe risk of electroshock which might be fatal. The **ATR19** shall not be operated with the lid open

### II. All **ATR19** versions

Now you may change settings and jumper positions or exchange **DLATR** boards. For removing a **DLATR** board pull gently (simultaneously) on the upper and lower edges of the board. When you insert a board again first mate it to the input pins near the front panel then press the 25pin connector gently into the socket and insure that the

connections are firm. Make sure that the settings on the **DLATR** board are correct and correspond to the **ATR19** version (ECL or NIM, see Chapter 3.2).

In order to change the settings for the signal level of timing outputs (ECL or NIM) it is required to remove the level control boards from the base board after loosening the front panel from the housing. This procedure and especially the re-assembly is complicated and not a recommended procedure for inexperienced users. If you want to change your **ATR19** module between ECL and NIM versions please contact **RoentDek**.

These are the following options for the signal output levels on the ECL and NIM output connectors:

Standard NIM: JP1/JP3 and JP2/JP4 set, JP22/JP23 open (as in Figure 3.4)

The timing output from the CFD is present on the “NIM” LEMO connector as standard NIM level.

If JP1/JP3 is left open the CFD output signals will also be present on the upper pin (red dot) of the “ECL” LEMO connector as the positive ECL+ level. Please inquire before you intend to use this option.

Standard ECL: JP22/JP23 set, JP1/JP3 and JP2/JP4 open

The timing output from the CFD is present on the “ECL” LEMO connector as standard (differential) ECL levels. The ECL+ level is found at the pin near the red dot and the ECL- at the lower pin. Additionally, the ECL- level is supplied via a 50Ω resistor in line to the “NIM” LEMO connector for control (see Chapter 3.3)

If JP2/JP4 is set and JP22/JP23 is left open the ECL- level is directly present on the “NIM” LEMO connector without in-line resistor. Please inquire before you intend to use this option.

If you change the settings of your **ATR19** between ECL and NIM you must also change the settings on the **DLATR** boards (see Chapter 3.2).

To close the top lid (**ATR19-6/8-channel** version), take off the rear panel again. Insert the top lid into the guiding slots and fix the rear panel tight with the screws. For **ATR19-2** refer to Chapter 3.6.

### 3.6 The ATR19-2(b) module

The **ATR19-2(b)** module is a 2-channel (1 **DLATR** board) version of the above-described **ATR19** module series. It measures 3HU (19” rack height units) and has no internal mains adapter.

The **ATR19-2b** can be operated with the supplied 12V mains adapter, which can supply several units (at least 4) chained in series via rear panel connectors. For operation of the older version **ATR19-2**, ±6V DC (600mA) need to be supplied via the rear panel connector, e.g. from the **SPS1(b)**.

All other functions / settings are identical to the **ATR19-6** or **ATR19-8** module versions.

To open the module remove the screws on the front and rear panel which fix the right side panel (the one with holes). Now you can remove the side panel and have access to the **DLATR** board inside. For complete disassembly and full access to all parts remove also the remaining screws on front and rear panel.



Figure 3.9: ATR19-2b module



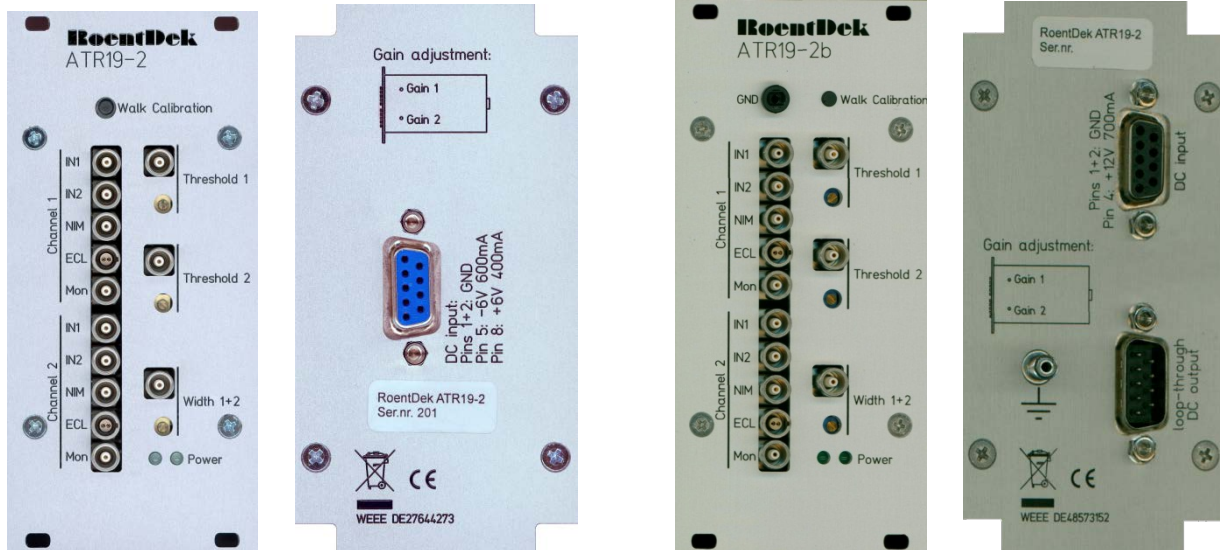


Figure 3.10: Front and rear panel of the ATR19-2 (left) and ATR19-2b (right)

### 3.7 Final Adjustment for detector operation

The **ATR19** units were specifically designed for the read-out of **RoentDek** delay-line detectors (**ATR19-6** for DLD, **ATR19-8** for HEX) and timing detectors (**ATR19-2**). The **ATR19-2** can also be used for the read-out of one delay-line layer.

If the voltages to the detector are supplied in the recommended way the signal from the MCP front or back contact (positive) has to be connected to ch1- or ch2- and the delay-line signals to ch3+ to ch6+ (or to ch8+). In case of **DET40/75** and **ATR19-2**: the signal from the MCP front or back contact (positive) has to be connected to ch1- and/or the signal from the timing anode (negative) has to be connected to ch2.

During the initial start-up procedure and whenever there are doubts about the high voltage robustness of the detector hardware, only the MCP signal should be connected for verifying the general detector (MCP) function. After an initial start-up procedure you have verified signals and the noise level from the detector. Assuming all wire connections are correct and all detector potentials are applied you should see similarly shaped analogue output signals on MCP front/back and the delay-line (monitor outputs). The outputs from the delay line should have similar signal heights. If not, the amplification factors on the DLATR boards should be adjusted (see Figure 3.2).

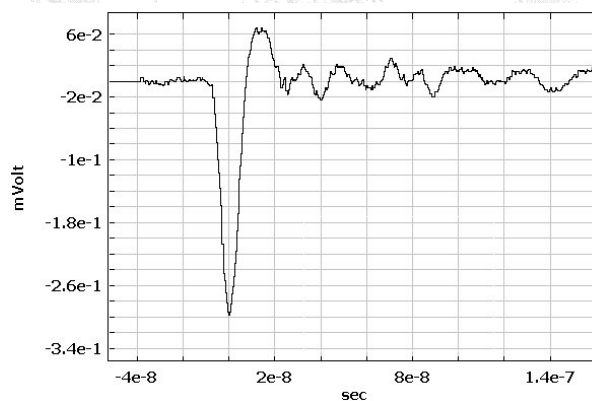


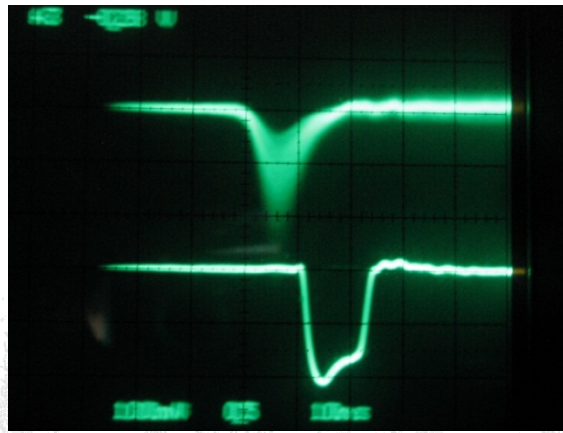
Figure 3.11: Typical amplified pulse shape of the MCP as obtained from the ATR19 analogue monitor output.

The analogue signal height on MCP back or front (channel 1 or 2) linearly corresponds to the charge of the electron cloud delivered from the MCP for a respective particle. As long as the output pulse height is smaller than 400mV (negative polarity) the shape of the pulses resembles the input signals that enter the constant fraction stage. For older **DLATR** boards the analogue output saturates at this value, however, internally (at the CFD input stage on board) the pulse height can be higher and is still linear. For normal noise levels below 50mV sufficient imaging results are obtained if the pulse heights distribution has a mean value of 300mV. The lowest pulse height should still be higher than the noise level. To increase the pulse height one can increase the MCP bias (not exceeding the maximum recommended value!) or the amplifier gain. If you increase the amplifier gain please be aware that the noise level will increase proportionally to the amplification factor. The signal-to-noise ratio, limiting detector

performance, can only be improved by increasing MCP gain (which may require reducing amp gain for avoiding saturation effects and non-linear amplification).

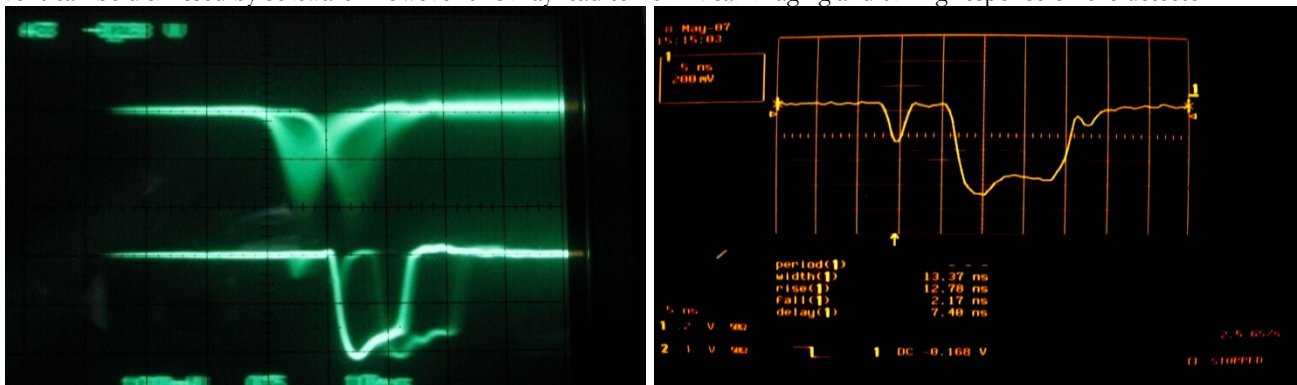
If the analogue outputs are satisfactory, one can check the corresponding timing (CFD) outputs on the sockets “NIM” or “ECL”. If your module is set to NIM-output levels you can directly verify the signals on an oscilloscope (coax input, 50Ω terminated). For the ECL output setting the presence of signals can be probed likewise on the NIM output with an oscilloscope (but with at least 1MΩ input impedance). Note that this may disturb the signal from the ECL output). Now the thresholds on all channels can be adjusted, ideally so that even the smallest pulse heights from particle/photon triggered MCP charge cloud are above the threshold but noise is still fully discriminated (typical threshold level 1.5x - 2x higher than the continuous noise level).

Figure 3.12 shows such a typical case. It should be noted that it may be beneficial to allow occasional noise triggers in order to safely detect also the smallest real signals and not to “lose” counts. This will not lead to false data because if they do not appear on all signal chains or if such random counts can be dismissed in coincidence-triggered measurements. Such signals will either not be processed by the data acquisition or can easily be sorted out later during data analysis (see below).

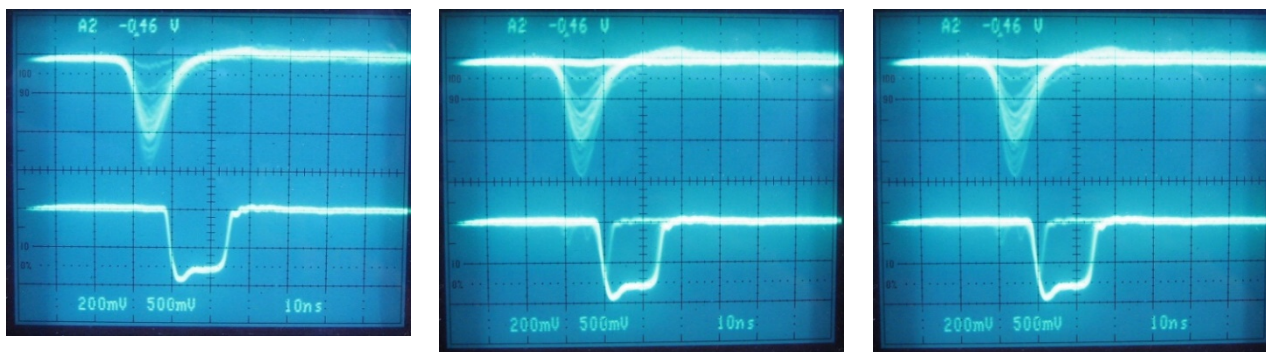


**Figure 3.12: Typical (analogue) oscilloscope screen output showing delay-line signals from a DLATR+ board: analogue signals (monitor output) on upper trace and the correlated CFD outputs (NIM) on the lower trace. Both traces are triggered by the NIM signal. The pulse height distribution of the analogue signals can be seen and also the effect of the threshold setting on the registered events (cut-off of smaller signals not being registered).**

However, one should avoid a too-low threshold setting which may cause a so-called “pre-trigger” operation mode of the CFD circuit. In this mode the CFD threshold will not block off signals that have been slightly distorted by noise in a way that the CFD circuit can function normally, see Figure 3.13. If the pre-trigger signal is registered a false time will be measured. For delay-line signals this can be recognized in a false time sum for this detected particle / photon on the respective layer and the event can be dismissed by software. However this may lead to non-linear imaging and timing response on the detector.



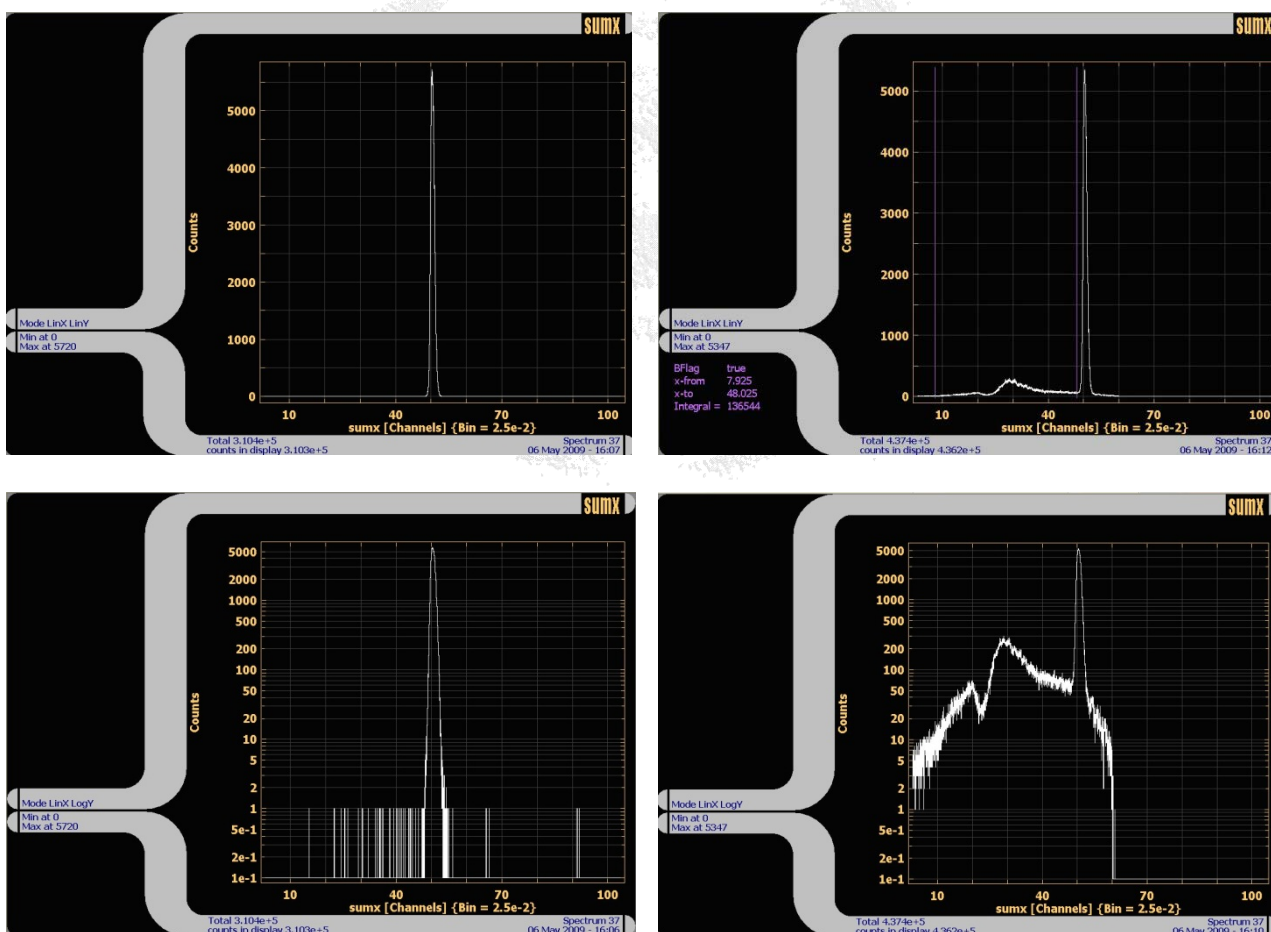
**Figure 3.13: Signal traces as in Figure 3.12, but with low threshold setting very close to the noise level (left). Pre-triggered signals are present. The right picture shows the CFD output of an erroneous pre-triggered event.**



**Figure 3.14: Overview of ATR19 signal outputs for low threshold settings, triggered on the CFD signal.**

Figure 3.14 shows signals at low threshold values. Ideally, the threshold should be set so low that all valid input signals produce a NIM-output from the CFD stage (left image) but high enough to exclude noise triggers (as in the middle image) and pre-triggers (as in the right image). The spurious per-trigger events can be identified by a small signal appearing occasionally just before the “main” NIM signal on the CFD output line.

If a RoentDek delay-line detector is used the presence of such events can be clearly observed in the time sum spectrum during data acquisition, see Figure 3.15. Ideally, the time sum on each layer consists only of one narrow peak with few ns width (lower pictures left side). Pre-trigger events contribute a more or less continuous “background” of falsely timed signals (lower pictures right side). It should be noted, however, that also a too high threshold level on the CFDs for the delay-line leads to a “non-perfect” time sum spectrum.



**Figure 3.15: Time sum spectra from a delay-line anode for different threshold setting. Left: clean spectrum, right: contribution of noise and pre-trigger signals can be seen. Setting a software gate on the time sum peak may still produce results with a decent imaging performance.**



### 3.8 The SPS1(b) mains adapter

The **RoentDek SPS1/SPS1b** are external power supplies for the **RoentDek (N)DLATR8**, **(N)DLATR6** and **ATR19** units. The **SPS1b** can also supply the **CFD1b**.

The **SPS1** provides DC-outputs ( $V_{out}$ ) adjustable between 5V and 6V, both positive and negative from 100-125V/200-250V, 50/60Hz AC mains power. The **SPS1b** provides  $\pm 6V$  and additionally -5.2V on a separate line. A switch on the back panel is used to select the mains power range.  $V_{out}$  can be adjusted between 5V and 6V. The output voltages are supplied via a 9-pin Sub-D connector which is compatible with the external power input sockets of the **RoentDek (N)DLATR8**, **(N)DLATR6**, **ATR19** (and **CFD1b**) units.

The **RoentDek SPS1** is ready for use. To prevent any damage or injuries, please read the following sections before. The **RoentDek SPS1** power supply works with hazardous mains voltage. Always make sure to:

- keep the **SPS1** power supply dry (use indoors only)!
- never insert any objects into the ventilation openings of the **SPS1** power supply!
- never block the ventilation openings on the top and bottom of the case!
- only operate the **SPS1** power supply while the case is closed!

#### 3.8.1 Connecting the SPS1

Figure 3.16 shows the connectors on the rear panel of the SPS1 power supply. The power switch is located on the front panel.

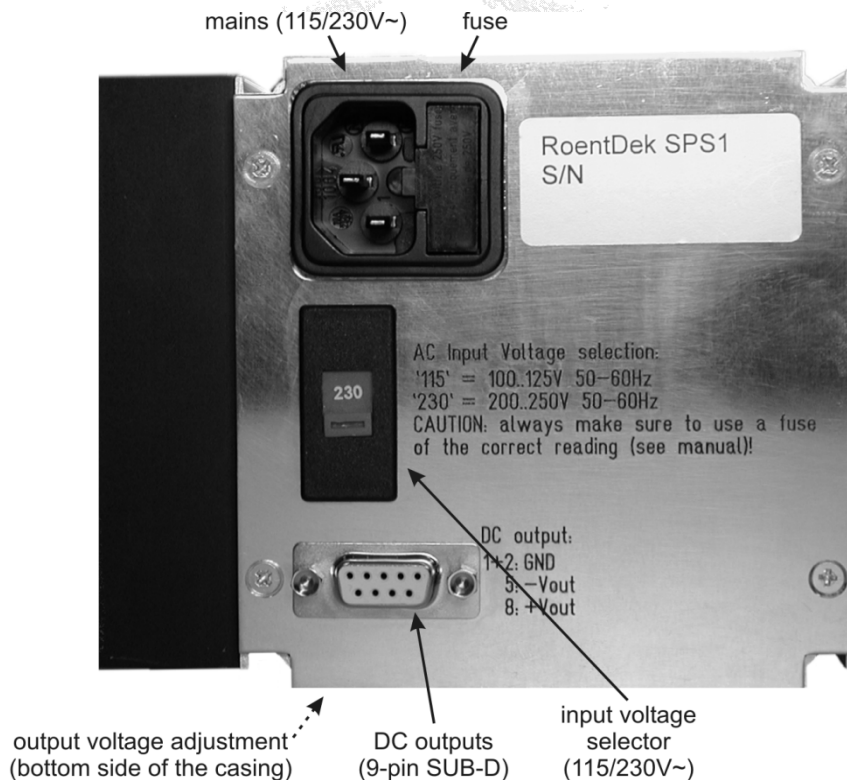


Figure 3.16: Connectors on the back of the SPS1.

The SPS1b features two identical output connectors which additionally provide -5.2V on pin 3.

**CAUTION:** Before connecting or disconnecting any cables always make sure that the power switch on the front panel is in its 'off' position (digit '0' can be seen).

- Make sure that the correct AC input voltage range is set:
  - '115' for operation with 100-125V AC 50-60Hz
  - '230' for operation with 200-250V AC 50-60Hz
 If the wrong range is set, see chapters 3.8.2 for changing the supply voltage range and the input fuse.

- b) Connect the **SPS1** power supply to the mains voltage. You will need a standard three-pole mains cord with protective ground (IEC320/EN60320 C14 connector, rated at 250V 10A).

**CAUTION: Make sure to use only power outlets with a proper protective earth connection.**

- c) Connect your **(N)DLATR6**, **(N)DLATR8** or **ATR19** device to the **SPS1**'s output connector. You will need a 9-pin Sub-D male-male cable with the following three pins connected 1:1.

Pin no.	Voltage
1+2	GND
5	-V <sub>out</sub>
8	+V <sub>out</sub>
3	-5.2V (only <b>SPS1b</b> )

**Table 3.1: Pin assignments of the 9-pin Sub-D output connector**

Do not use standard RS-232 cables or similar since they do not have the wire cross-section needed for the high output currents of the **SPS1**. Only use cables with a cross-section of at least 0.75mm<sup>2</sup>. Use shielded cables if possible.

**CAUTION: Do not connect any other devices than the RoentDek (N)DLATR6, (N)DLATR8, ATR19 (or CFD1b) to the SPS1(b) before checking with RoentDek.**

The **SPS1** output is not short-circuit proof. If you short-circuit or overload the outputs, the internal fuses will have to be replaced by new fuses of the same rating (250V F1.6A for positive output, 250V F2.5A for negative output. F='flink'=quick acting). You will have to open the casing for replacing the internal fuses. Make sure to disconnect the mains cord and the output cable before opening the case!

Please note that in its standard configuration the **RoentDek ATR19** unit is equipped with an internal power supply. The **ATR19** does not automatically switch from this internal to an external power supply. If you bought an **ATR19** device with internal power supply and want to operate it using an external power supply like the **SPS1**, you will have to disable the **ATR19**'s built-in power supply first (for details please refer to the **ATR19** manual).

### 3.8.2 How to switch the AC supply voltage

The **RoentDek SPS1** power supply can be switched between 100-125 and 200-250 Volts AC supply voltage range. Always make sure that the supply voltage range is set correctly before connecting the mains voltage.

**CAUTION: Selecting the wrong input voltage may cause severe damage to the SPS1 power supply and/or the attached devices!**

In order to change the input voltage, remove the mains cord. Then simply slide the input voltage switch to the desired position. The actual input voltage setting ('115' or '230') will be shown. After that make sure to use the right input fuse before using the **SPS1** (see below).

	use only:	
100V AC	250V 0.63AT	(630mA slow blow = träge = T)
115-125V AC	250V 0.5AT	(500mA slow blow = träge = T)
200V AC	250V 0.315AT	(315mA slow blow = träge = T)
230-250V AC	250V 0.25AT	(250mA slow blow = träge = T)

**Table 3.2: Used fuses**

Use 250V fuses only. Fuse size must be Ø 5mm x 20mm.

**CAUTION: Never use the SPS1 with a fuse of a different rating than stated above! Never bypass the fuse!**



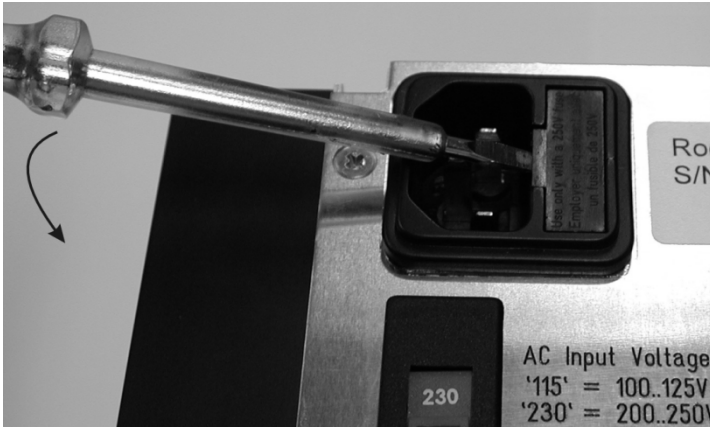


Figure 3.17: How to remove the input fuse

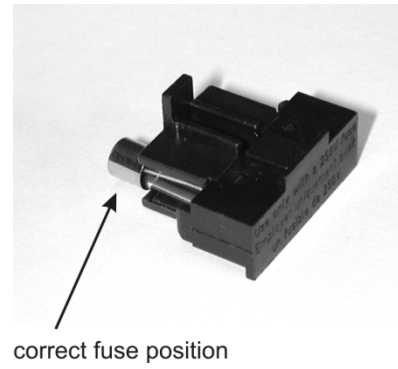


Figure 3.18: Fuse holder

### 3.8.3 Output voltage adjustment

Both output voltages may be adjusted if necessary. The two potentiometers are accessible from the bottom side of the **SPS1**'s casing (see Figure 3.19). For safety reasons use a fully insulated screwdriver to adjust the potentiometers.

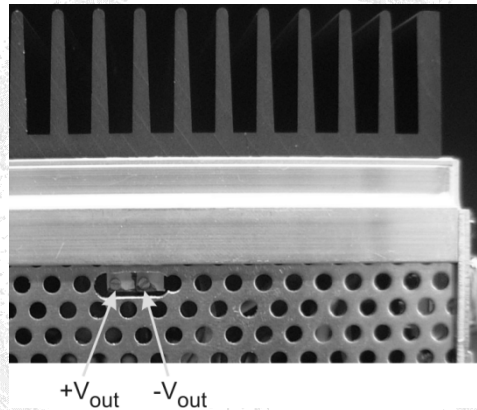


Figure 3.19: Adjusting the output voltages (SPS1 seen from bottom side)

### 3.8.4 Maintenance and Troubleshooting

For cleaning, please use a clean, dry or slightly moist cloth only. Remove the power connection first. Do not use any chemicals for cleaning. Always make sure that no liquids enter the case.

If any problems occur, disconnect any devices from the **SPS1** power supply and directly measure the output voltages. You may try to solve the problem using the following overview:

Problem	Possible reasons:
all output voltages missing	- no mains voltage - input fuse broken (see Chapter 3.8.2) - both internal output fuses broken (overload or short-circuit has occurred)
one output voltage missing	- internal output fuse broken (overload or short-circuit has occurred)
output voltage incorrect	- re-adjustment of the output voltage needed (see Chapter 3.8.2).

Table 3.3: Troubleshooting

Please note that the green power switch may light only very dim when the **SPS1** is operated at 100-125V.

### 3.8.5 Technical Specifications

Protection Class:	IP20
AC Input Voltage:	100-125V or 200-250V (selection switch is at the rear panel), 50-60Hz
DC Outputs:	positive output: 5.0 .. 6.0V (adjustable), max. 1.2A negative outputs: -5.2V (fixed) max. 1A -5.0 .. -6.0V (adjustable), max. 2.2A both negative outputs COMBINED may not exceed 2.2A!
Power Consumption:	typ. < 3W standby (no device connected) typ. < 45W full load ((N)DLATR8 or ATR19 with 8 amplifier channels)
Storage conditions:	-20 – 60°C, max. 80% humidity
Operating conditions:	10 – 40°C, max. 80% humidity
Weight:	2.3kg
Dimensions (stand-alone):	
Width:	130mm
Height:	130mm
Depth:	190mm (Insertion depth with all cables connected: < 250mm)
Dimensions (19" rack mounting):	
Front Panel:	3 height units (U), 21 width units (HP),
Total Width:	< 26 width units (HP) including heat sink
Insertion Depth:	< 250mm including connection cables

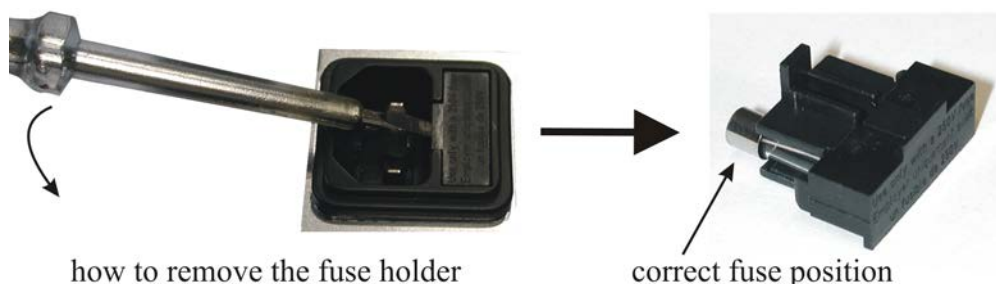
### 3.9 Troubleshooting the ATR19's internal mains power supply

This chapter shall assist you in fixing problems with the **ATR19** (not **ATR19-2**) internal mains supply, which is very similar to the **SPS1**. It describes procedures to verify the internal power supply and how to change fuses in case of problems. A problem with the internal power supply is indicated if some of the green LED in the front panel are not lit or the voltages in the front panel test points are not between 5.5 and 6.5V, both polarities. A FAQ (Frequently Asked Questions) list on the **ATR19** and its functions is continuously updated. Please refer to our WEB site for updates of this manual.

- 1) Turn on the **ATR19**. **Check if the green power switch is lit** (the switch illumination might be very dim if the **ATR19** is operated with 100-115 VAC).

If not: check the power connection. Check the fuse at the back panel of the ATR19 (fuse holder is integrated into the mains plug socket, see picture below) and replace when necessary. Only use fuses of the following readings:

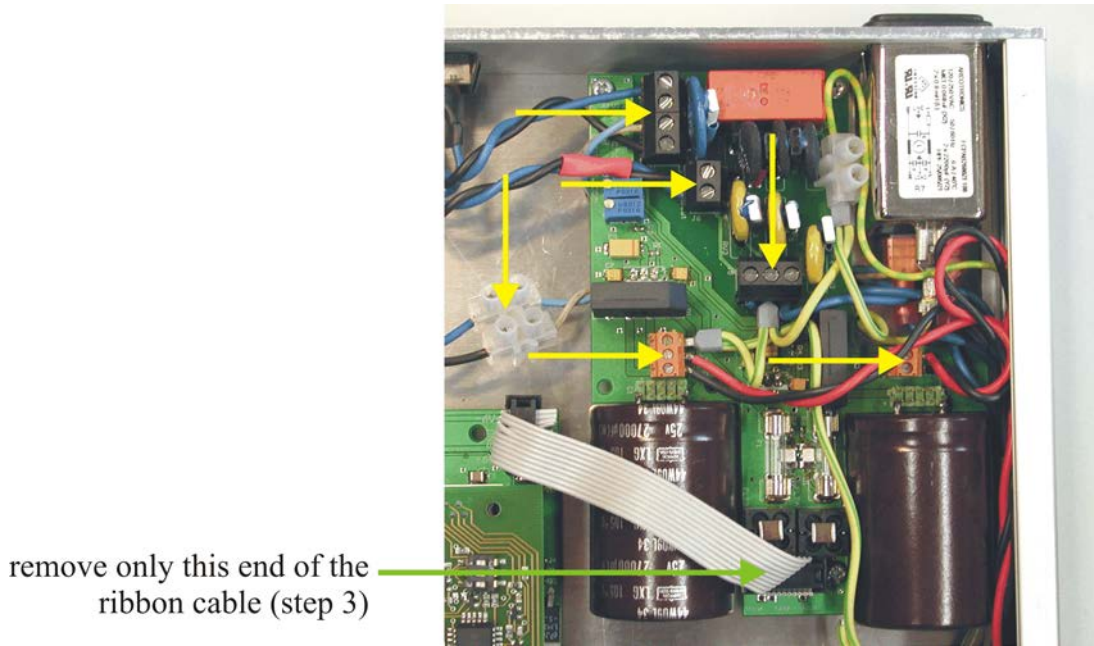
- 250V 630mAT when operated at 100 VAC
  - 250V 500mAT when operated at 115 VAC
  - 250V 315mAT when operated at 200 VAC
  - 250V 250mAT when operated at 230 VAC
- (T = (German:) träge = slow blow = time lag)



**Figure 3.20: Opening the fuse holder**

If the problem persists please follow steps 2) to 9).

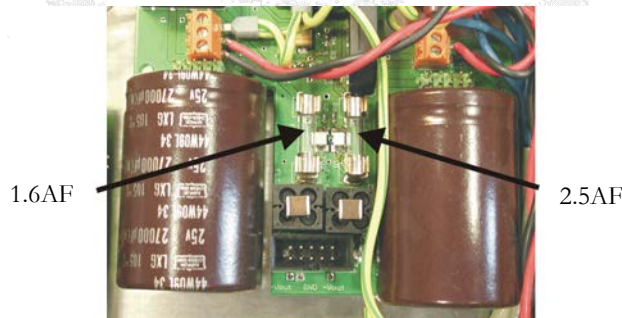
- 2) Remove the power cord and all other cables connected to the **ATR19**. Open the **ATR19** case. Check that all internal cables are correctly fixed in the terminals (yellow arrows in the picture below).



**Figure 3.21: Remove the ribbon cable from the power supply**

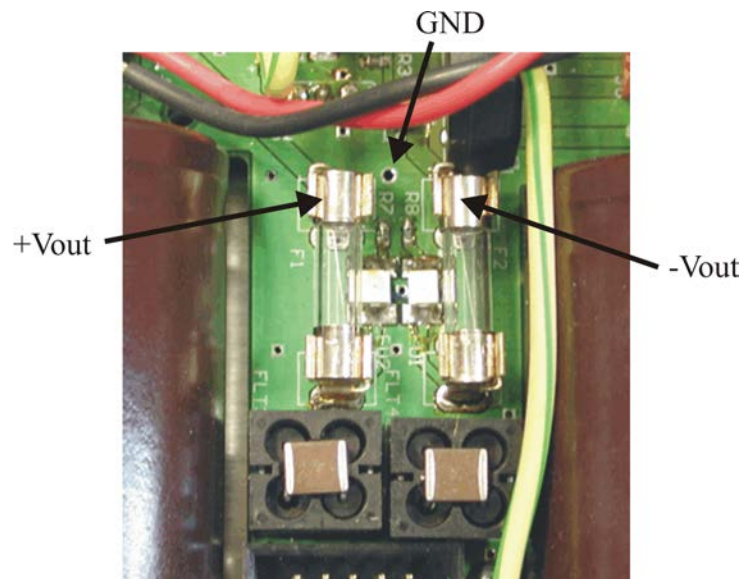
- 3) Remove the ribbon cable from the power supply (green arrow in the picture above). Make sure not to remove the other end of the ribbon cable. This will ensure that you will not invert polarity when reconnecting the cable later.
- 4) Check the output fuses (see picture below). If broken replace with fuses of the following readings:

F1: 250V 1.6AF  
 F2: 250V 2.5AF  
 (F = (German:) flink = fast acting)



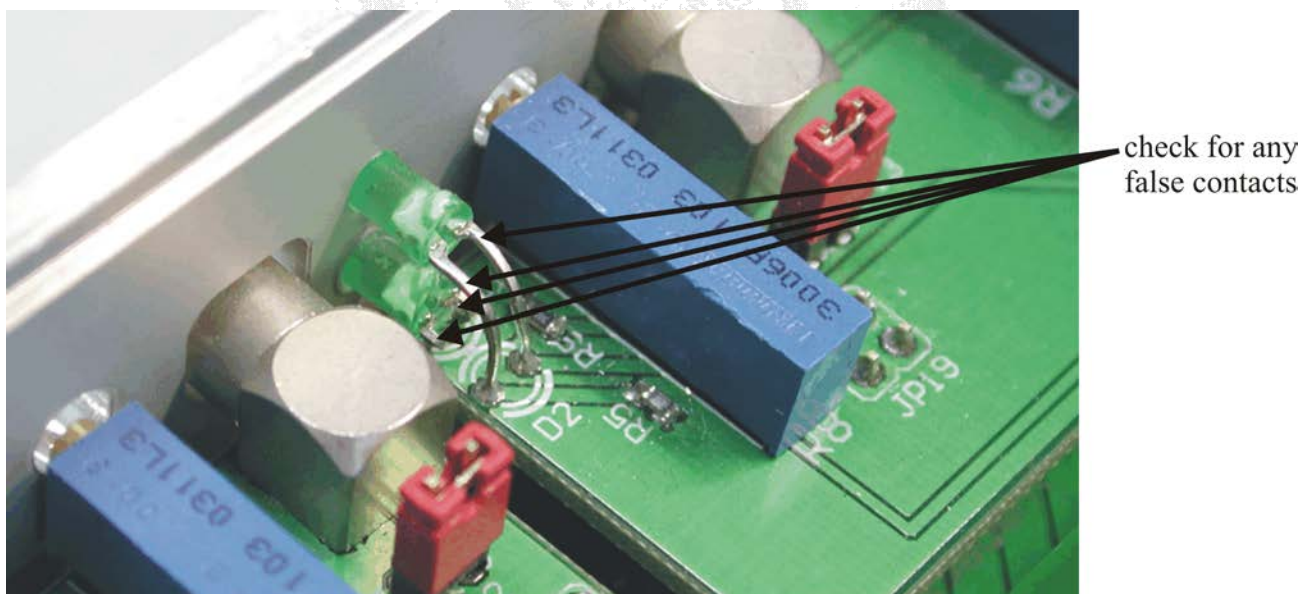
**Figure 3.22: Output fuses**

Use an ohmmeter to check that there are no short circuits between  $+V_{out}$  and GND resp.  $-V_{out}$  and GND (see picture below).



**Figure 3.23: Voltages near the output fuses**

- 5) Reconnect the ribbon cable to the power supply. Make sure that both connectors of the ribbon cable are firmly pressed in place.
- 6) Repeat step 4).
- 7) Check all the LEDs at the front panel (see picture below). Make sure that none of their pins touch each other or touch any other components of the **ATR19** since this might cause short-circuits. If necessary, bend the pins in order to remove any false contacts.

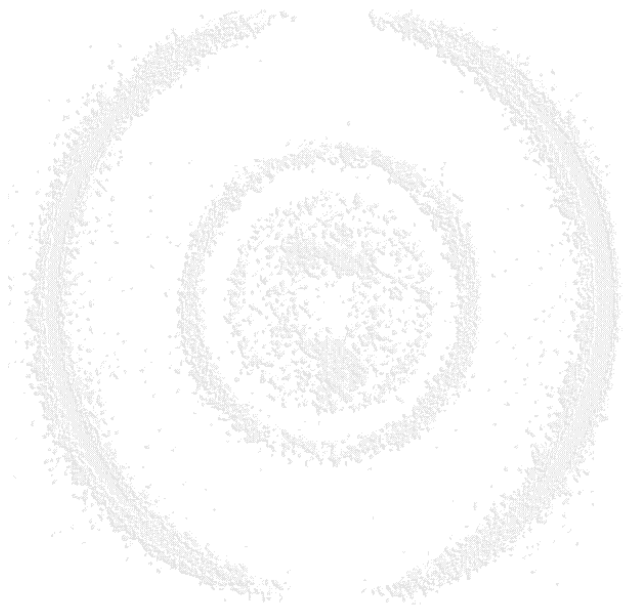


**Figure 3.24: LEDs at the front panel**

- 8) Close the casing of the **ATR19**.

Restore the power connection and check if the problem has been solved. If not, repeat the steps above. If the failure persists, contact **RoentDek** for further assistance.





## 4 Data acquisition Hard- and Software

**RoentDek** has developed data acquisition concepts for PCs, especially suited for correlated multi-parameter read-out. It consists of the software package **CoboldPC** with plug-ins for certain hardware applications. Currently Windows XP and Windows Vista and Windows 7 operating systems are supported. x64 (64 bit) OS systems are not supported for all hardware. Windows 8 is partially supported but not yet for hardware read-out.

For the data acquisition with **RoentDek** delay-line detectors we have developed three types of TDCs. The **TDC8HP**, **HM1(B)**, and the **TDC8** (for ISA and PCI bus). The **fADC** units are not yet documented in this manual. If you have purchased **fADC** units please contact RD. For all data acquisition hardware modules there are separate more detailed manuals available. Please see <http://roentdek.com/manuals/>.

### 4.1 The Time-to-Digital-Converters (TDC) for PC

**RoentDek** currently delivers different TDC modules for PC, the **TDC8HP**, **HM1** and the **TDC8**, all suitable as stand-alone units controlled by PC (**CoboldPC** software): The **TDC8HP** is available as a PCI board. The **HM1** can be delivered with an ISA or PCI I/O card that needs to be inserted into the PC. The **TDC8** exists as an ISA-PC plug-in board and in a PCI version (this product line discontinued).

#### 4.1.1 TDC8HP

The **TDC8HP** system is based on the CERN HPTDC chip. The **TDC8HP** system consist of the **HPTDC8** board and the **CoboldPC** software. This card is in function very similar to the older **TDC8PCI2** board.

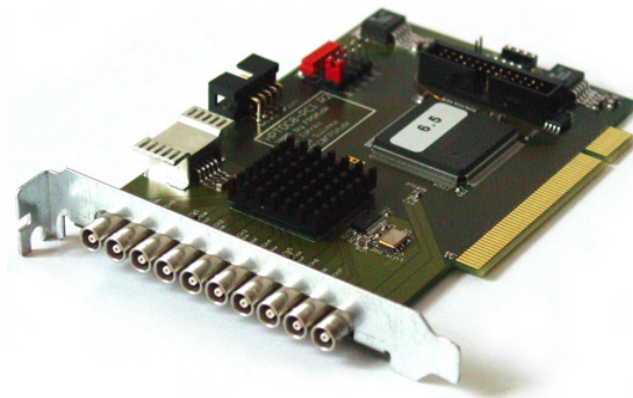


Figure 4.1: HPTDC8 PCI Card

The **TDC8HP** continuously record the digital waveform (high/low) on its inputs similar to a logic analyzer. **TDC8HP** features are:

- 8 NIM compatible inputs on LEMO connectors with 25ps LSB
- 1 NIM compatible input on LEMO connector with 12.8ns LSB
- typical deadtime between multiple hits on one channel <5ns
- unlimited number of hits per trigger
- no dead time due to readout, new data is acquired during readout
- 4M Hits/s maximum readout rate, with **CoboldPC** the read out rate is about up to 1.3MEvents/s
- 419µs range w. trigger logic enabled
- 2h range without trigger logic, can be extended by software (with **CoboldPC 2011**)
- adjustable trigger window (size, position of trigger)
- easy to use driver for windows operating systems
- on board storage for calibration data
- support for up to three event-synchronized boards
- 5V, 32-bit, 33MHz PCI target device

Typical applications for a **TDC8HP** include atomic physics experiments (e.g. momentum imaging, time-of-flight spectroscopy), mass spectroscopy.

A **PCI2PCIe** adapter is available which allows the read-out of **TDC8HP** modules via PCIe bus and via further adapters to laptop computers.

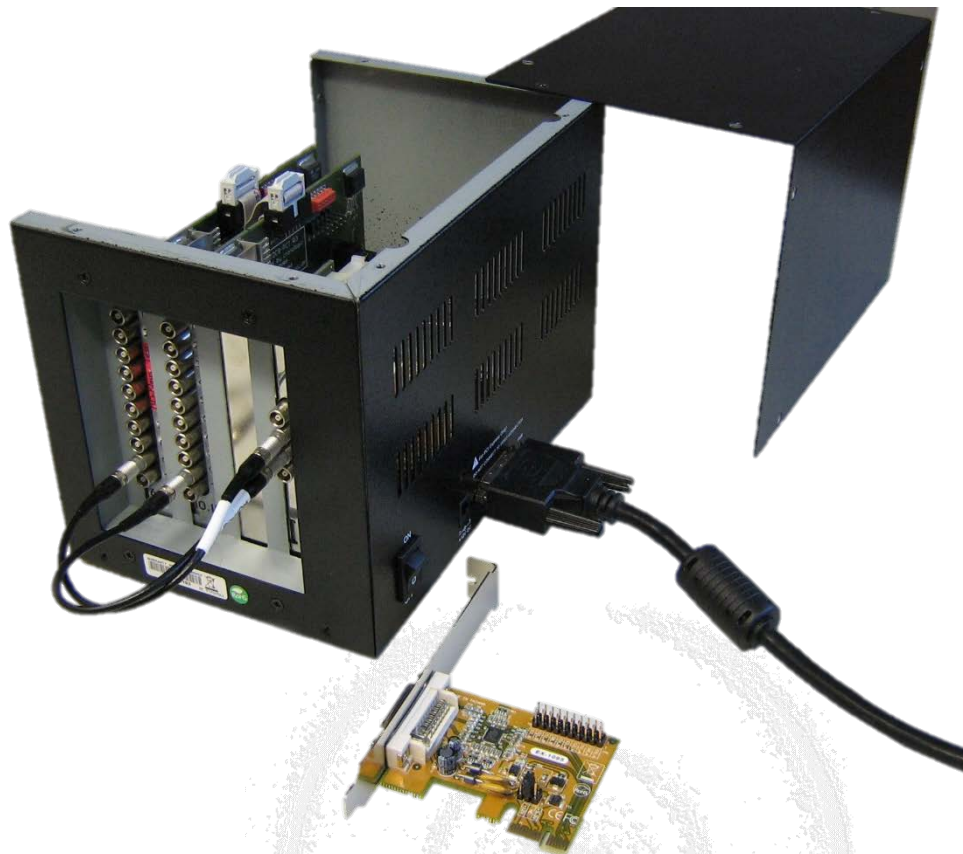


Figure 4.2: PCI2PCIe adapter crate with PCIe card for the PC. Here two TDC8HP and a clock card are inserted

The PCI2PCIe adapter requires a mains cord with IEC-60320-C7 norm (only the EURO version of this cord can be supplied by **RoentDek**).

#### 4.1.2 The HM1 / HM1-B

The **HM1** is based on the GP1-chip of ACAM. It has a common-start input and 4 channels of stop inputs, all differential ECL. The resolution is 133ps or better (adjustable) the range is 14bit or up to 30bit in a special long-range mode (resolution and pulse-pair separation ability reduced). It can be operated in three modes:

- In the standard mode, “transparent mode”, it can detect up to 3 or 4 hits per channel with a pulse pair resolution of about 15ns. The data acquisition (DAQ) in this operation mode is managed by the PC. The DAQ speed is limited to about 18kHz, divided by the number of hits to be detected per channel. The data are stored in list-mode on the PC- hard disc. Two **HM1** modules can be combined to a double module featuring effectively an 8-channel version (with half read-out speed), e.g. for coincident read-out two **DLD** detectors (ISA version only).
- The *burst mode* is a pre-calculated transparent mode (only available in the **HM1-B** module). The values for  $x_1, x_2, y_1$  and  $y_2$  are calculated inside the **HM1-B** Module to  $x, y$  and  $z$ .  $x, y$  and  $z$  is then coded into a single 32bit value. The number of bit for  $x, y$  and  $z$  can be programmed. This 32bit value is store in a small FIFO. Only 1 hit can be detected in this mode. This mode is mostly controlled by the **HM1-B** itself, therefore the DAQ speed is about 150kHz.
- In the so called *histogram mode* (optional, not for **HM1/T**) the DAQ speed is significantly enhanced (more than 1MHz). The data (only single hits per channel are registered) are stored on the TDC board in a 2D histogram (X and Y position, 11bit) or 3D histogram (X, Y and Z=TOF) memory. After a measuring cycle the content of the histogram can be transferred to the PC in a block for further data treatment. A dual memory bank on the board allows continuous data taking even during data transfer to the PC. The range of the TDC is limited by the histogram partitioning.

The **HM1-B** is fully compatible to the **HM1** as well as the **HM1/T** model. Additionally to the **HM1** this module has the *burst mode* ability.



Figure 4.3: HM1-B/T and HM1-B front panel

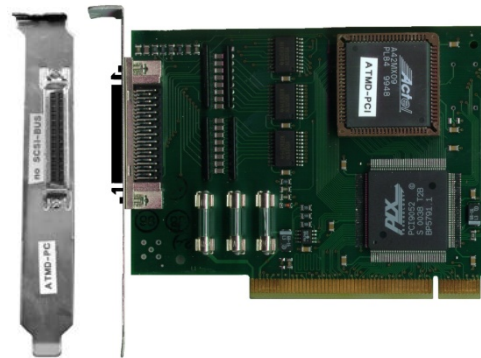


Figure 4.4: PCI interface card

Details of the HM1(-B) operation is given in a separate manual. **HM1** modules cannot be operated with x64 OS.

### 4.1.3 The TDC8

(This product line is discontinued!)

The **TDC8** is based on the LeCroy MTD133B-chip (production discontinued). It has an input for common start or common stop operation and 8 channels. It operates only in “transparent mode” (list mode) and can collect up to 16 hits per channel. The resolution is 500ps and the range is 16 bit. The input level is NIM. Up to three **TDC8** can be combined. Especially, two of the **TDC8** can be coupled to an effective 15 (ISA) or 16 (PCI) channel single start/stop TDC.

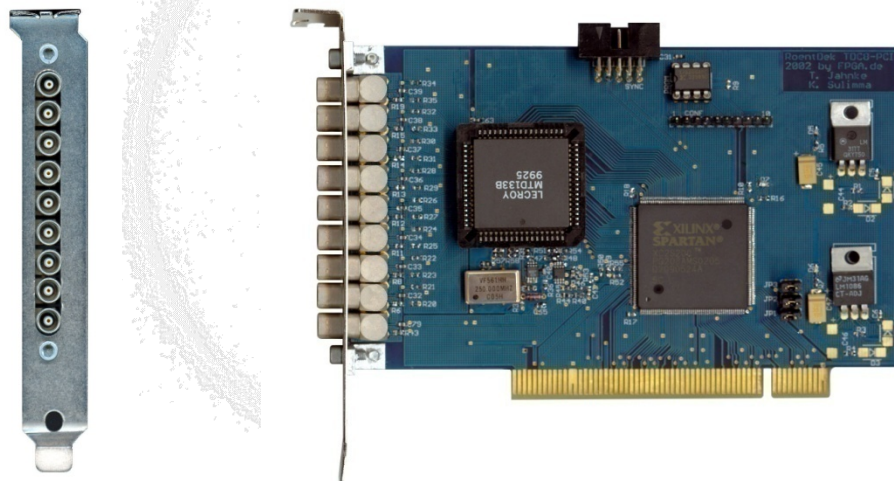


Figure 4.5: TDC8PCI2 board

For details of the TDC8 module versions please refer to the separate manual.

## 4.2 Hard- and Software Installation

### 4.2.1 TDC8HP

- Shut down your computer
- For your devices safety, turn off the power to your computer and all peripheral devices.
- Drain static electricity from your body by touching the metal chassis (the unpainted metal at the back of your computer)
- For your personal safety, remove the power cord from your computer
- Remove the cover of the computer as described in your computer’s manual.



- Locate a free PCI slot in your computer, and firmly insert the card into the selected slot. To avoid damaging your hardware, insert the card only into a slot with the same bus type as the card. Inserting the card into any other type of slot can damage your card, your computer, or both.
- Firmly secure the adapter with a screw (or clip), to ensure that the adapter is properly grounded to the computer's chassis.
- Replace the cover of the computer as described in your computer's manual.

For a detailed description and how to install **TDC8HP** drivers please refer to the **TDC8HP** manual

#### 4.2.2 HM1 / HM1-B

- Shut down your computer.
- For your devices safety, turn off the power to your computer and all peripheral devices.
- Drain static electricity from your body by touching the metal chassis (the unpainted metal at the back of your computer).
- For your personal safety, remove the power cord from your computer.
- Remove the cover of the computer as described in your computer's manual.
- If necessary adjust the I/O address setting on the I/O card to a free I/O address (ISA-I/O card version only). Do not forget to adjust *parameter 1* in your .pcf file to this I/O address or set the value of this parameter to 0 to automatically determine the I/O address.
- Locate a free ISA/PCI slot in your computer, and firmly insert the card into the selected slot. To avoid damaging our hardware, insert the card only into a slot with the same bus type as the card. Inserting the card into any other type of slot can damage your card, your computer, or both.
- Firmly secure the adapter with a screw (or clip), to ensure that the adapter is properly grounded to the computer's chassis.
- Replace the cover of the computer as described in your computer's manual.
- Connect the HM1 module with the I/O card using the connection cable. The three green LED on the HM1 module should be on now.

Note that the I/O card is not using SCSI signaling standard, although it has a SCSI socket and cable.

**Major damage to your hardware will occur if you connect a SCSI device to the HM1 interface card or the HM1 to an SCSI controller.**

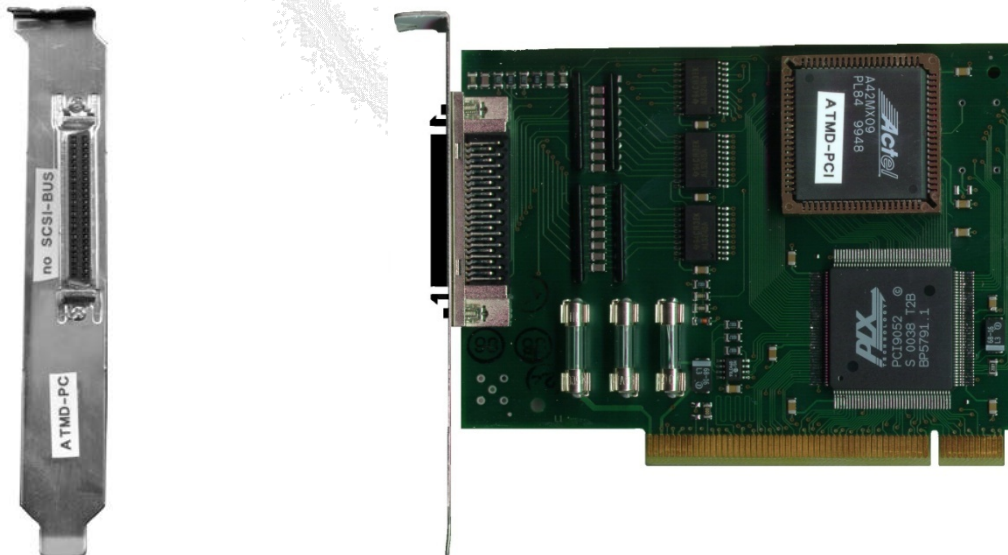


Figure 4.6: Side and input panel view of the HM1 - I/O-board (PCI)

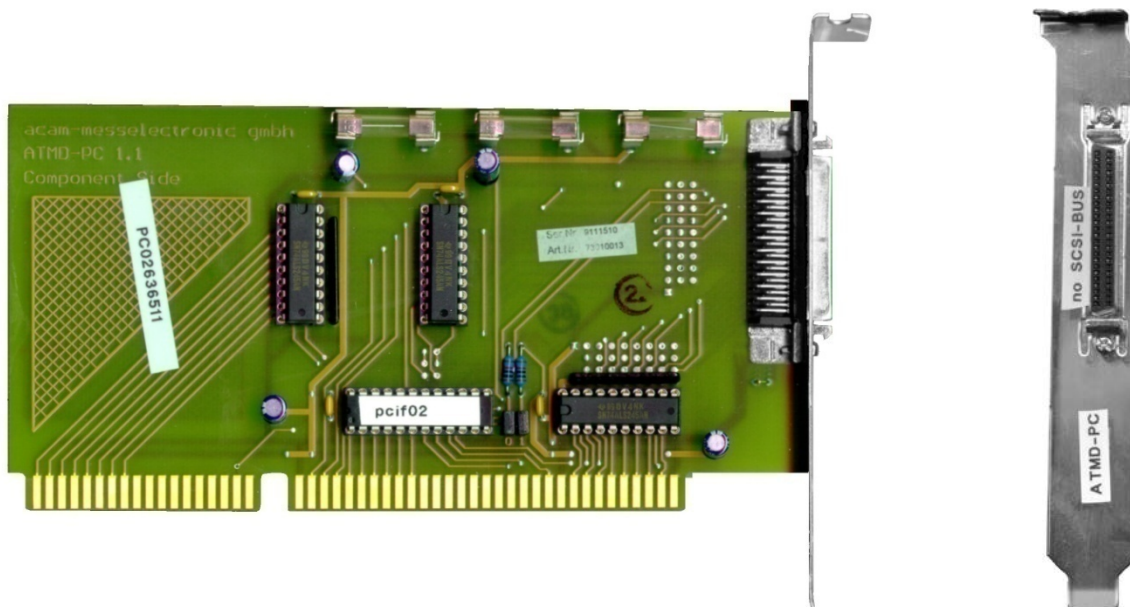


Figure 4.7: Side and input panel view of the HM1 - I/O-board (ISA)

For a detailed description please refer to the HM1-B Module manual

#### 4.2.3 TDC8

(This product line is discontinued!)

- Shut down your computer
- For your devices safety, turn off the power to your computer and all peripheral devices.
- Drain static electricity from your body by touching the metal chassis (the unpainted metal at the back of your computer)
- For your personal safety, remove the power cord from your computer
- Remove the cover of the computer as described in your computer's manual.
- Adjust the I/O address setting on the card to a free I/O address.  
Do not forget to adjust parameter 1 in your .pcf file to this I/O address. For the PCI-Version set this parameter to 0.
- Locate a free ISA or PCI slot in your computer, and firmly insert the card into the selected slot. To avoid damaging your hardware, insert the card only into a slot with the same bus type as the card. Inserting the card into any other type of slot can damage your card, your computer, or both.  
The **TDC8PCI** needs two PCI slots even though it connects only to one PCI slot connector.  
The **TDC8PCI2** needs only one PCI slot!
- Firmly secure the adapter with a screw (or clip), to ensure that the adapter is properly grounded to the computer's chassis.
- Replace the cover of the computer as described in your computer's manual.

#### **Note for TDC8PCI(2) board!**

Normally the PCI support in the BIOS is set to "Plug and Play" for operating systems that can handle plug and play components like Windows 2000 or Windows XP. In very rare occasions, the TDC is not working in this mode. In this special case the TDC card is detected but no data taking can be initiated. A DAq Software like CoboldPC will therefore give no warning that the TDC could not be detected but the event rate will always be zero.

In this case try to switch the PCI support in BIOS from "Plug and Play" to "None Plug and Play" and try again.

For a detailed description please refer to the **TDC8** manual

### 4.3 Connecting the ATR19 or CFD with the TDC

Before you finally connect the TDC with the **ATR19** or CFD units you should have verified that the detector and the **ATR19** or **CFD** unit are operating properly.

### 4.3.1 TDC8HP (or TDC8)

*(You should have installed the TDC card already in the PC)*

Connect via the short LEMO coax cable the **TDC8HP** channel 8 (in case of **TDC8** input “C”) with the timing (CFD) output (NIM signal only) used for the MCP signal. Likewise connect the outputs of the delay line anode timing signals to the channels 1 to 4(6) according to Chapter 0 of the manual.

*For **TDC8** only: If you have received cables of different lengths use the four or six long cables for that. For coincidence experiments it is often of advantage to operate in “common stop” mode and supply a delayed trigger signal to the common input (to arrive after the last significant signal in channels TDC1-8. Such a signal can be a coincidence trigger, to collect only selected events.*

Note that this is only the standard connection scheme, for other connecting schemes the software must be adapted. Additional channels can be used for other signals to be correlated (i.e. from a second detector or a TOF trigger).

Operating two or more **TDC** modules:

If you operate two **TDC8HP** modules only channel 8 of the first **TDC8HP** board (lowest TDC ID) have to receive the trigger signal. Additionally connect the “External Clock” Module with each **TDC8HP** channel “C”. Also apply the flat ribbon cable to the two **TDC8HPs** (on top of the card). The two **TDC8HP** board will now operate as a virtual “**TDC16HP**” board with doubled input channels. The TDC with the lowest TDC ID provides channels 1-9 (1-8 and T on the board) and the other board the channels 10-17 (1-8 on the board). A third **TDC8HP** can also be linked in the same way.

*For operation of two **TDC8** modules: both common inputs must receive the same (trigger) signal. Additionally one TDC channel in each module must receive the same signal to ensure correlation between the modules (by software).*

*Note, that the **TDC8** needs a minimum time difference of about 10ns between start and stop signals in case of “common start” operation. It is then advisable to use cable sets so that the common input cable is at least 3m shorter than the other input cables.*

### 4.3.2 HM1 / HM1-B

Connect the TDC start via the short two-pin cable with the timing (CFD) output (ECL signal only) used for the MCP signal. Use the four long cables to connect the (stop) channels x1, x2, y1 and y2 for the delay-line CFD timing output channels 3, 4, 5 and 6 according to Chapter 0 of the manual. If a **NIM2ECL** converter is used, it is placed between the CFD NIM output sockets and the **HM1** inputs.

If you operate two **HM1 / HM1-B** as a double unit, the “start” needs to be supplied to both modules (ISA version only).

## 4.4 Starting the CoboldPC 2011 R3 Software:

Once the software is successfully installed you are ready to run a **CoboldPC** session from a pre-acquired list-mode file to make you acquainted with the software (found on the CD in folder *CoboldPC2011SampleFiles*). For this it is not necessary to install or operate any hardware but you have to have all drivers installed. We have provided you with a sample file (list-mode file) that was acquired with the hardware that you have received (or similar hardware) on the CD\*. From now on you may also refer to the **CoboldPC** help file (this has replaced the **CoboldPC** manual) as this small section can give only a very brief overview how to get started.

**CoboldPC 2011** loads the DAq (Data Acquisition module) and DAn (Data Analysis module) dynamically. After starting the program the first time you have to specify the right DAq and DAn modules. This can be accomplished in either the About-Box or in the File-Menu. DAq modules are normally named like DAq\_\*.dll and DAn modules as DAn\_\*.dll. 64-Bit modules contains “x64” in the filename. For the DAq module please select the one with the appropriate hardware that you have purchased that will support the readout of your hardware. These files can be found in the main **CoboldPC** installation directory.

If you have purchased the **HM1** with histogramming option please refer also to the **HM1-TDC** manual. The following procedure is mainly describing the start-up in the standard (transparent mode), which is recommended for first use of the detector system.

After starting the **CoboldPC 2011** program and selecting the appropriate DAq and DAn modules (there is a flag to load the last selected DAq and DAn modules at start time) the program has linked the proper program parts and waits for input from the command line (type the command text and “enter”) or the tool bar buttons. With the command “exe filename.ccf” or from the drop down menu you can start a “batch-file”, i.e. a series of commands as written in the file (new line = next command). For example any “Startup.ccf” file (see below) defines a set of parameters, coordinates, conditions, and spectra necessary for a **CoboldPC** session. A dialogue box will ask you to define the type of session, hardware acquisition or re-sorting of a previously acquired listmode-file.

---

\* If you should not find the file corresponding to your hardware please contact [software.development@roentdek.com](mailto:software.development@roentdek.com)

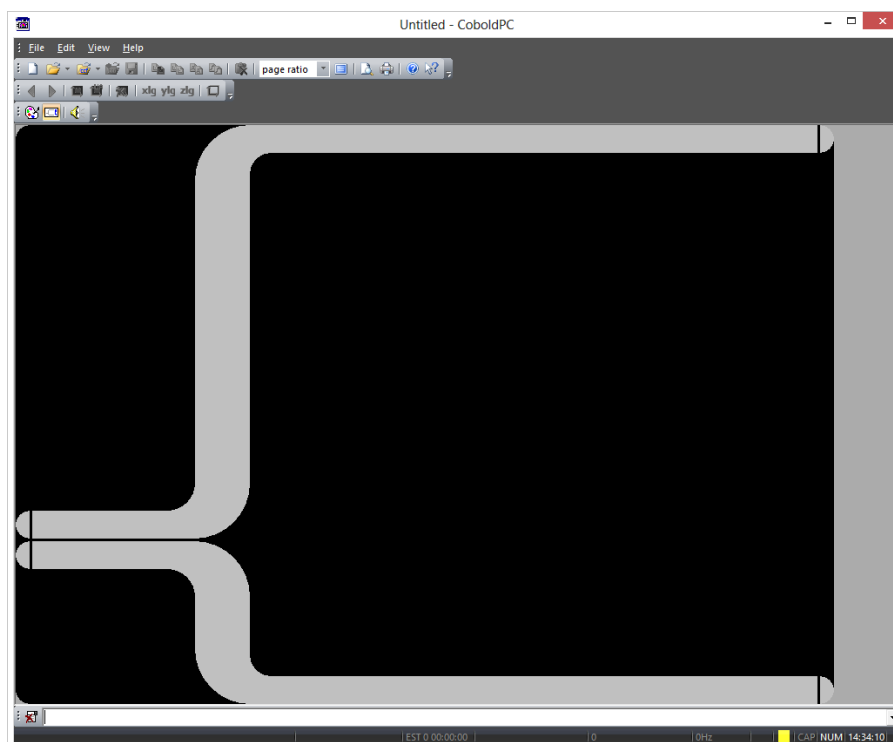


Figure 4.8: Screen after starting the CoboldPC 2011 R3 program

You will recognize corresponding files easily from the similarities in the filenames. Browse for a “filename.lmf” and select it\*. If you have selected an adequate listmode file. The program will resume and sort the file. Now you can look at the spectra with the “view” command. First you may check with the “show spectra” command which spectra are defined and can be displayed. If you have not yet referred to the **CoboldPC** help file so far, it is time for that now in order to proceed. Some frequently used standard commands are listed below:

<b>exe</b>	calls a command file
<b>new hardware</b>	prepares for starting hardware acquisition
<b>start</b>	starts the acquisition
<b>pause</b>	pauses the acquisition (for starting again use the start command)
<b>stop</b>	stops the acquisition (for starting again use the new hardware and the start command)
<b>clear all</b>	clears the contents of all spectra (instead of all, a certain spectrum number is also possible to clear only one spectrum)
<b>restart</b>	deletes all coordinates, parameters, conditions and spectra for a total reset
<b>coordinate</b>	defines a coordinate
<b>parameter</b>	defines a parameter
<b>condition</b>	defines a condition
<b>define1</b>	defines a 1-dimensional spectrum
<b>define2</b>	defines a 2-dimensional spectrum
<b>view 1</b>	shows spectrum 1
<b>show status</b>	shows the status report window
<b>help</b>	shows the help file

We have prepared a startup command file “Startup.ccf” which contains all commands for reading out the TDCs **TDC8HP**, **HM1** or **TDC8PCI2**. It provides already most of the desired definitions, i.e. 2d position spectra and time-of-flight spectra in

\* If you should not find the file corresponding to your hardware please contact [software.development@roentdek.com](mailto:software.development@roentdek.com)



various coordinate representations. The program calls a sub-script for defining hardware-specific parameters which must be chosen (default: **TDC8HP**)\*. Due to this modular construction it is possible to use almost the same data analysis sequences for different hardware, i.e. TDC types.

The parameters from 0 up to 999 are reserved for DAq-parameters.

If you use other hardware than the **TDC8HP** you are requested to modify one command:

For **HM1**: remove the “;” in front of the command lines:

```
;execute HM1-DAQ-Parameters.ccf
and
;LoadDAQModule DAq_HM1.dll,Applicationpath
```

For **TDC8PCI2**: remove the “;” in front of the command lines

```
;execute TDC8PCI2-DAQ-Parameters.ccf
and
;LoadDAQModule DAq_TDC8PCI2.dll,Applicationpath
```

Generally, everything from “;” (including) on in a command line will be ignored as input, i.e. it is considered as a comment.

The “Startup.ccf” begins with the following commands/parameter settings common to all different hardware components, followed by hardware-specific commands, data analysis specific commands and finally commands to define spectra and begin the data acquisition (see sub-sections):

Restart	reset of any earlier commands and definitions
setpath APPLICATIONPATH	sets the file paths to the directory containing the Cobold.exe
LoadDAnModule DAn_Standard.dll,Applicationpath	loads the DAn module
LoadDAQModule DAq_TDC8HP.dll,Applicationpath	loads the hardware DAq module.

For **HM1** or **TDC8PCI2** replace **TDC8HP**

Internally used parameters are marked in a gray color.

Parameter 2 *Time stamp* for an event as obtained from the CPU (or TDC in case of the **TDC8HP**) in seconds. Setting this parameter to 1 or 2 will record the time stamp with each event as 32bit or 64bit value (0 = acquisition start). Please note that the accuracy of the recorded time is not guaranteed. In case of the **HM1** and **TDC8PCI2** the CPU time is written with an accuracy of a several microseconds. In case of the **TDC8HP** the internal TDC clock is with an accuracy of 25ps.

0 = no Timestamp,  
 1 = 32Bit Timestamp (Low.Low, Low.High)  
 2 = 64Bit Timestamp (Low.Low, Low.High, High.Low, High.High)

Parameter 5 *Time scaling* (internal parameter). Used to calibrate the time stamp.

Parameter 6 DAq-version number (internal parameter)

Parameter 7 Start time of list mode file (internal parameter)

Parameter 8 DAq-ID (internal parameter)

DAQ_ID_RAW	0x000000	for RAW (no Data)
DAQ_ID_HM1	0x000001	for HM1 (single)
DAQ_ID_TDC8	0x000002	for TDC8/ISA/PCI
DAQ_ID_CAMAC	0x000003	for CAMAC
DAQ_ID_2HM1	0x000004	for 2 HM1
DAQ_ID_2TDC8	0x000005	for 2 TDC8
DAQ_ID_HM1_ABM	0x000006	for HM1 ABM Mode
DAQ_ID_HM1_LR	0x000007	for HM1 LR Mode
DAQ_ID_HPTDC	0x000008	for TDC8HP

Parameter 9 LMF-version number (internal parameter)

Parameter 20 TDC resolution in ns. (internal parameter. Do not adjust)

Parameter 21 TDC data type information (internally set)

0 = Not defined  
 1 = Channel information  
 2 = Time information (in ns)

Parameter 32 number of channels (from 1) to be read out

\* You may replace this “execute” command by directly copy & pasting the commands in the called sub-script for your hardware option at this position in the startup file.

Parameter 33 number of hits per channel to be read out  
 Parameter 40 DataFormat (Internally set)  
 Parameter 50 unique ID-number checking compatibility of CCF with DAn and DAq

#### 4.4.1 Hardware specific commands: DAq-parameters and coordinates

execute TDC8HP-DAq-Parameters.ccf executes the commands in the specific file, here for **TDC8HP**, if you use different hardware please enable a different sub-script execution (see above)\*.

The following commands are part of the TDC8HP-DAq-Parameters.ccf sub-script, for details please refer to the **TDC8HP** manual. For the commands in the other parameter files for **HM1** and **TDC8PCI2** please also refer to the specific manuals:

```
Parameter 50,201102080000 ;check-ID (tests compatibility of CCF/DAq)
Parameter 53,1 ;display only every (n)th event but write all events to hard drive (for high rate measurements)

Parameter 60,0 ; 0 = don't read driver config file (default 0)
Parameter 61,0x000000 ; RisingEnable, 0 = none (e.g. 0x40 = channel 7)
Parameter 62,0x0ff1ff ; FallingEnable, Channel 1-9 on first TDC and channels 1-8 on seconds TDC
Parameter 63,0 ; TriggerEdge, 0 = falling
Parameter 64,8 ; TiggerChannel,channel 8 for trigger
Parameter 65,0 ; OutputLevel, 0 = false
Parameter 66,1 ; GroupingEnable, 1 = true = 25ps binsize and max. +-200µs range
; 0 = false = 16ps binsize and max. +-32ms range
Parameter 67,0 ; AllowOverlap, 0 = false (0 = default)
Parameter 68,160 ; TriggerDeadTime, time in ns (recommended value: 10ns more than parameter 70)
Parameter 69,-150 ; GroupRangeStart, time in ns
Parameter 70,150 ; GroupRangeEnd, time in ns
Parameter 71,0 ; External Clock, 0 = false (0 = default, should be 1 if two TDCs are synched)
Parameter 72,1 ; OutputRollovers, 1 = true (1 = default)
Parameter 78,1 ; VHR (TDC8HP only: 0 = 100ps LSB, 1 = 25ps LSB)
Parameter 79,0.2 ; Group Timeout in seconds (default 0.2s, do not adjust)
Parameter 80,0 ; INL, 0 = false = do not read file (default)
Parameter 81,0 ; DNL, 0 = false = do not read file (default)
Parameter 86,1 ; MMXEnable (never set to 0, always 1)
Parameter 87,1 ; DMAEnable (never set to 0, always 1)
Parameter 88,0 ; time zero channel:
; set all trigger times (parameter 64) relative to last hit in this channel
; please set to 0 if not used
; "Grouping" must be disabled (parameter 66)
Parameter 89,0x00000000 ; Trigger channel mask (active only when parameter 66 is set to 0)
```

From these DAq parameters the following are of special interest and are therefore explained also here:

```
Parameter 53 NumberOfDAQLoops (normally 1)
To increase online event reading speed you can increase this value. If set to n then you'll process n Events
in the DAq module before returning the last event to CoboldPC. In online processing only the nth event
will be passed to the analysis but all events will be written to the LMF.

Parameter 64 TriggerChannel: Determines the trigger input channel (1-9)
Parameter 68 TriggerDeadTime: Defines the time range in ns before a next signal in the trigger channel will be considered
as the trigger for the next event. Recommended value: 10ns more than parameter 70.

Parameter 69 GroupRangeStart: from this time (in ns, minimum -2E5) relative to the trigger signal all signals in the other
channels are registered as belonging to the same event until

Parameter 70 sets the GroupRangeEnd as time in ns (maximum 2E5) after the trigger for this event.
Parameter 78 VHR-flag: Enables the TDC8HP's very high resolution mode with an LSB of 25ps (set to 1). Per default
this parameter is set 1 (25ps LSB). For multi-hit measurement with short dead-time demand it is
recommended setting this parameter to 0.
```

\* You may replace this "execute" command by directly copy & pasting the commands in the called sub-script for your hardware option at this position in the startup file.

Call UserFCall,SetDAQCoordinates,T1Ch??n,T1Ch??S?? ; defines coordinates for number of hits per channels and values for each hit according to parameters 32 and 33. This command (for parameter 32 = 8 and parameter 33 = 2) is the equivalent to the following "manual" coordinate definition block:

```
Coordinate T1Ch01n,T1Ch01S01,T1Ch01S02;
Coordinate T1Ch02n,T1Ch02S01,T1Ch02S02;
Coordinate T1Ch03n,T1Ch03S01,T1Ch03S02;
Coordinate T1Ch04n,T1Ch04S01,T1Ch04S02;
Coordinate T1Ch05n,T1Ch05S01,T1Ch05S02;
Coordinate T1Ch06n,T1Ch06S01,T1Ch06S02;
Coordinate T1Ch07n,T1Ch07S01,T1Ch07S02;
Coordinate T1Ch08n,T1Ch08S01,T1Ch08S02;
```

note that it is possible to define several coordinates in one command line separated by “,”.  
Example: T1Ch02n is the coordinate for the number of hits in TDC channel 2  
T1Ch03S01 is the coordinate for the value of hit 1in TDC channel 3  
T1Ch04S02 is the coordinate for the value of hit 2in TDC channel 4

It is mandatory that the number and order of these so-called DAq coordinates are in accordance with the algorithms in the DAq Dll module and the Dan Dll module and also with the settings of parameters 32 and 33. The hardware coordinates and the *time stamp* coordinate (optionally) are stored in the list mode file if this function is enabled before the data acquisition starts (see new command).

The previous parameters of the DAq part have the function to define and organize the hardware (and are mandatory), the set of so-called DAN parameters is used in the data analysis part. During offline analysis of an earlier acquired list mode file some of these parameters are automatically set from the parameter information (settings during data acquisition) that is stored in the header of the list mode file.

For further computations with the obtained raw data (DAq coordinates), the DAN.dll as a data analysis subprogram uses these DAq coordinates and creates computed coordinates (DAN coordinates), such as the position or time sum (TOF) derived from the raw data. It also comprises some correction, shifting and rotation computations and coordinate system transformations, so that the basic computations for experiments with a position and time sensitive detector are already available without changing the DAN.dll as it was supplied with the **CoboldPC** program.

The DAN-coordinates are internally treated as independent coordinates and are internally listed by numbers, following the last DAq coordinate. However, the DAN coordinates will not be appended in the list mode file.

The DAN.dll may be altered using the Microsoft-C++ compiler of Visual Studio 2010 or above (see **CoboldPC** help file) and the list of coordinates may be changed (with any text editor), creating additional coordinates (and parameters) for further computation, unused DAN coordinates may be removed. Any newly defined coordinate is available for further computations. Note that the program will only operate normally, if all definitions are in accordance with the DAq Dllly module and Dan Dll module used. After the new and start commands the program makes a consistency check and may give an error message if the number of coordinates and parameters defined are not sufficient, however, it will not detect all possible discrepancies.

#### 4.4.2 Analysis specific commands: DAN parameters and coordinates

The parameters from 1000 onwards are reserved for DAN parameters. Note that some parameters (for DAq and DAN) are set automatically or values may be overwritten when reading a previously recorded list mode file.

The following DAN parameters used in the Dan part can have the function of variables for computations, of pointers or of flags. Some are mandatory, some are optional. The Standard DAN will use the parameter range 1000-1999.

```
Parameter 1050 check-ID (tests compatibility of CCF/DAN), for CoboldPC 2011 R3 the value is 201102080000
Parameter 1000 internal DAN calibration parameter, do not change
Parameter 1002 Hexanode calculation flag
                    0 = no Hexanode
                    1 = Hexanode
                    If a Hexanode is used additional calculations are required to retrieve the position information. For these
                    parameters and coordinates please refer to the add-on manual.
Parameter 1003 R-Phi coordinates conversion
                    0 = RAD [-π..π]
                    1 = RAD [0..2π]
                    2 = DEG [-180..180]
                    3 = DEG [0..360]
                    This parameter defines the angular range and unit for the phi coordinate in the R-Phi representation of the
                    2d-image.
Parameter 1004 DNL correction (GP1/HM1 only)
```

0 = no DNL correction  
1 = Correction value (typically 0.31)

- Parameter 1005 Start of DAq Data for DAn (Start Coordinate)  
Parameter 1006 Start of DAn Data (Start Coordinate)  
This pointer value defines the position in the coordinate list where the DAn coordinates begin, i.e. it should equal the number of hardware coordinates.  
If you want to analyze the data from the first hit you can set this value also to -1 and the program will automatically enter the right number.
- Parameter 1007 Hit number to be analyzed. Usually the position coordinates are calculated from the first hit in the TDC channels (default value: 1). If you instead want to get position and time sum coordinates calculated for a different hit number you have to enter the hit value here. Note that it can happen that the values from different channels do not necessarily correspond to the desired particle hit number if reflections on the raw amplifier signals or missed signals produce “false” hits in a certain TDC channel.
- Parameter 1010 Time to Position calibration factor for  $PosX$  coordinate ( $v_{\perp}$  in mm/ns)  
DLD40: 1.32, DLD80: 1.02, DLD120: 0.77  
For Hexanode (u): HEX80: 0.737, HEX120: 0.583
- Parameter 1011 Time to Position calibration factor for  $PosX$  coordinate ( $v_{\perp}$  in mm/ns)  
DLD40: 1.43, DLD80: 1.13, DLD120: 0.82  
For Hexanode (v): HEX80: 0.706, HEX120: 0.567  
These two parameters define the value of position to time calibration, the effective signal propagation speed across the delay-line. It depends on the size and geometry of the delay-line used. The suggested values are only accurate within few percent for a given delay-line. If a higher precision is needed one needs to make a position calibration with a test mask in front of the detector. If the detector image boundary has an oval shape, exchange the values for X and Y (only for DLD) and try again sorting the data (may be the physical dimensions of the anode have been exchanged during mounting).
- Parameter 1012 Time to Position calibration factor for the w-layer (Hexanode only):  
HEX80: 0.684  
HEX120: 0.540

Please note that it is required to calibrate the numbers for parameters 1010-1012 for your anode more accurately. Please contact [service@roentdek.com](mailto:service@roentdek.com)

Parameters 1013 to 1019 can be used for defining bin sizes of spectra (see spectra definition commands below)

```

parsemathcommand reset;
parsemathcommand p1013 = p1010*0.5*(int(p20*1000)*0.001); // high resolution binning
parsemathcommand p1014 = p1011*0.5*(int(p20*1000)*0.001); // high resolution binning
parsemathcommand p1015 = p1010*2*(int(p20*1000)*0.001); // normal resolution binning
parsemathcommand p1016 = p1011*2*(int(p20*1000)*0.001); // normal resolution binning
parsemathcommand p1017 = p1012*2*(int(p20*1000)*0.001); // normal resolution binning
parsemathcommand p1018 = p1010*8*(int(p20*1000)*0.001); // coarse resolution binning
parsemathcommand p1019 = p1011*8*(int(p20*1000)*0.001); // coarse resolution binning
parsemathcommand execute;

```

- Parameter 1020 Rotation offset center for coordinate  $PosX$   
Parameter 1021 Rotation offset center for coordinate  $PosY$   
These parameters define the center point for an online detector image rotation and also the center point in the X/Y plane for a coordinate transformation into R/Phi representation. Note that R/Phi transformation will only give good results if the position unit is mm (see parameter 1000).
- Parameter 1022 Rotation angle in mathematical direction (counter clock wise) for an online detector image rotation (value to be supplied in RAD or DEG depending on parameter 1003)
- Parameter 1023 X-value of center for  $r/\phi$  coordinate computation  
Parameter 1024 Y-value of center for  $r/\phi$  coordinate computation  
Parameter 1025 MCP channel number. If the trigger signal is NOT the MCP signal the parameter 1025 shall contain the channel number of the MCP signal to achieve sum spectra with the time reference set to the MCP signal.

Parameters 1026 to 1032 can be used to change the assignment of the “raw” DAQ coordinates from TDC channels to the calculated (DAN) coordinates  $x1$ ,  $x2$ , ...

- Parameter 1026 channel number for  $x1$



Parameter 1027	channel number for x2
Parameter 1028	channel number for y1
Parameter 1029	channel number for y2
Parameter 1030	channel number for z1 (ignored if parameter 1002 = 0)
Parameter 1031	channel number for z2 (ignored if parameter 1002 = 0)
Parameter 1032	channel number for TOF (-1 if not used)
Parameter 1035	Offset for <i>PosX</i>
Parameter 1036	Offset for <i>PosY</i>
	These two parameters are offset (additive) constants for shifting the detector image in the X/Y plane. Note, that in case of the Hexanode these values define the offsets for the calculated x and y and not for the raw u and v values.
Parameter 1037	Offset for third anode layer (added to w, only for Hexanode)
Parameter 1038	Offset for <i>Sum/Diff</i> coordinate calculations.
	This offset value is an additive constant to all time <i>Sum/Diff</i> coordinates
Parameter 1039	Anti-Moire (0 = no, 1 = yes)
Parameter 1040	Reset EventCounter (1: reset after "new" command, 0: no reset)
Parameter 1041	Integration time in seconds for <i>RealTriggerRate</i> coordinate
Parameter 1060	Condition flag; value will appear as value in coordinate <i>Condition1</i>

The following DAn coordinates are by definition only the additional coordinates that are computed from the (raw) DAq coordinates retrieved from the hardware or from a previously accumulated event file (not part of a list mode file). Here, only one set of delay-line coordinates for one of the hits (default: first hit, see parameter 1005) is selected and position and time coordinates are calculated. If you have changed parameter 2, 32 or 33 from their default value (first hit only) or if you sort a list-mode file acquired with a non-default parameter settings you need to adjust the (pointer) parameters 1005 and 1006. It is such possible to apply the position and time calculations to the next hits if such are (or have been) acquired. The DAn module will read the values of the status registers and the value in the 4 (Hexanode: 6) raw position coordinates (and optional TOF) defined by parameter 1005 (default: first hits) and calculate the desired position and time information. Note that even for the use of a DLD (4 delay-line signals only), the coordinates for two additional delay-line signals (as from a Hexanode) are defined but set to 0. A set of DAn coordinates is created by using the defined set of DAq coordinates:

Coordinate AbsoluteEventTime	defines the absolute event time and
Coordinate DeltaEventTime	the time between one event and the next
Coordinate EventCounter	event number since start or last event number reset
Coordinate True	internal coordinate
Coordinate False	internal coordinate
Coordinate ConsistencyIndicator	The value of this coordinate is: $\sum u \cdot 2^{i-1}$ , i is the TDC channel, u =1, if at least one hit in the TDC channel i was registered, otherwise 0. If each TDC-channel for the selected hit number has received at least one hit of the value is 15 for a DLD and 63 for a Hexanode. This assumes that the first TDC channels are used for the delay-line signals.
Coordinate PLLStatusLocked	internal coordinate for HM1 (see manual), must always be defined
Coordinate RealTriggerRate	calculates the trigger (count) rate (please see parameter 1041)
Coordinate Condition1	the value of this coordinate is set by a condition command
Coordinate n1,n2,n3,n4,n5,n6,n7,n8	number of hits in the TDC channels 1-8 (not higher than parameter 33)
Coordinate x1,x2	Values in the TDC channels 1-6, "position calibrated" in mm.
Coordinate y1,y2	If parameter 1010 to 1012 are set to 1 these values correspond to time calibrated
Coordinate z1,z2	values (in ns).
Coordinate TOF	Values in the TOF-TDC time calibrated in ns (please see parameter 1032)
Coordinate raw_x,raw_y,raw_w	difference of TDC channel values 1&2, 3&4, 5&6 (uncalibrated)
Coordinate raw_sumx,raw_sumy,raw_sumw	sum of TDC channel values 1&2, 3&4, 5&6 (uncalibrated)
Coordinate raw_sumxyw	sum of TDC channel values 1 to 6 (uncalibrated)

Coordinate <code>raw_diffxy</code>	sum of TDC channel values 1&2 minus sum of 3&4 (uncalibrated)
Coordinate <code>sumx,sumy,sumw,sumxyw</code>	same as <code>raw_sum...</code> but calibrated in ns and shifted (parameter values) example: $sumx = x1 + x2 + pOSum$
Coordinate <code>diffxy</code>	same as <code>raw_diffxy</code> but calibrated in ns and shifted (parameter values)
Coordinate <code>PosX,PosY</code>	calibrated position coordinates after shift/rotation (parameter values) example: $PosX = x1 - x2 + pOPx$ , and possibly rotated (for Hexanode: $Xw + pOPx$ and $Yw + pOPy$ )*
Coordinate <code>r,phi</code>	calibrated position coordinates in R/Phi coordinate system
Coordinate <code>Xuv,Yuv,Xuw,Yuw,Xvw,Yvw</code>	only for Hexanode: calibrated position coordinates retrieved from the respective two layers
Coordinate <code>dx,dY</code>	control coordinates: difference between $Xw/Xw$ and $Yw/Yw$
Coordinate <code>reflection_in_MCP</code>	control coordinate: time between second and first hit in TDC channel 8 (MCP) in ns.
Coordinate <code>reflection_in_x1,reflection_in_x2</code>	control coordinates: time between hit on one delay-line contact and
Coordinate <code>reflection_in_y1,reflection_in_y2</code>	second hit on the other contact of the same delay-line, for all layers and
Coordinate <code>reflection_in_z1,reflection_in_z2</code>	all ends (the latter two only for Hexanode)
Coordinate <code>Const1,Const2,Const3,Const4,Const5,Const6,Const7,Const8</code>	internal coordinates for the constants 1 to 8
CoordinateSet <code>n_matrix_y,T1Ch01n,T1Ch02n,T1Ch03n,T1Ch04n,T1Ch05n,T1Ch06n,T1Ch07n,T1Ch08n</code>	
CoordinateSet <code>n_matrix_x,Const1,Const2,Const3,Const4,Const5,Const6,Const7,Const8</code>	

The keyword "CoordinateSet" combines several coordinates in a group. In the example above the coordinates T1Ch01n to T1Ch08n are combined in a group with the name "n\_matrix\_y". In the histogram definitions these group names can be used as if they were normal coordinates. Thus the command

```
define2 0.,9.,1.,n_matrix_x,channel number,0.,8.,1.,n_matrix_y,counts,none,always,hit statistics
```

results in a 2D-histogram which is filled at the following 8 bin positions:

```
x=Const1 / y=T1Ch01n, x=Const2 / y=T1Ch02n, x=Const3 / y=T1Ch03n, x=Const4 / y=T1Ch04n
x=Const5 / y=T1Ch05n, x=Const6 / y=T1Ch06n, x=Const7 / y=T1Ch07n, x=Const8 / y=T1Ch08n
```

#### 4.4.3 Spectra and condition definition commands

The final purpose of the data acquisition is to display and analyze the acquired data. For this purpose it is possible to define *spectra* for displaying all defined coordinates. A spectrum is a histogram with a fixed bin width either with a one- or two dimensional array of "bins". For a one-dimensional spectrum (for example a time spectrum) this array is a row along the ordinate (X-axis) of a graph, the bins correspond to the values of the corresponding coordinate. When data is acquired or read from a list-mode file, the value of the coordinate for each event will be attributed to the closest bin's value and the histogram content in this bin will be incremented by one unit (along the Y-axis of the graph). For example such a histogram (spectrum) could show the distribution of time of flight values for a number of acquired events.

Likewise it is possible to display two-dimensional spectra, i.e. the coincident occurrence of values in two coordinates within the corresponding bin widths (for example the 2d position distribution of detected particles). To visualize such a histogram the two coordinates span a plane (X/Y), the value in each bin (Z) is displayed as gray or color scale, also contour lines or scatter plots can be used for the display. The range of the displayed spectra in X, Y (and Z), the bin size and the "unit" of incrementing can be defined for optimal visualization and manipulation.

To analyze higher dimensional coordinate correlations it is possible to "gate" the sorting process into a histogram (spectrum) by defining a *condition* for this spectrum. Such a condition can be a "window" (or "region of interest") on the occurrence of a certain range of values in a third coordinate for the events. For example: if one needs to visualize the (2d) position spectra of particles as function of their time-of-flight (TOF) one can define several conditions (gates) on the TOF coordinate (e.g. time sum peaks) and several 2d position spectra with the different conditions. It is possible to couple different conditions (e.g. by an "AND") to allow the analysis of even higher dimensional coordinate correlations.

---

\* In order to get an optimal image from a Hexanode it is important to calibrate the layers accurately using add-on software

For details about the definition of spectra and conditions, for spectrum manipulation options and data I/O to other programs please refer to the **CoboldPC** manual. In the following you find some pre-defined conditions (as examples) and spectra as part of the “startup.ccf” that will allow you to view the most important coordinates. For example, you will immediately be able to see a position spectrum. You may later edit the “startup.ccf” and all sub-scripts to adjust them to your needs, e.g. setting the right condition gates on the time sum peak(s), omitting spectra that you do not need, adjust parameters (for shifting or rotating the spectra, calibrating position and time), changing or appending spectrum definitions. For the Hexanode an extra software package is available to optimize its function. Please contact **RoentDek** on the availability of specific software packages for your application.

The following condition and spectra definition commands are recommended for first time users. Those definitions disabled by the “;” may also be of use and can be activated by removing the “;” in front of each command line:

```
condition ConsistencyIndicator,14.5,15.5,four;           true if x1,x2,y1 and y2 signals were registered
condition ConsistencyIndicator,62.5,63.5,six;           true if x1,x2,y1,y2 and z1,z2 signals were registered
condition four,or,six,clean_hit
```

Note that for the Hexanode it is recommended to rename the condition *six* by *clean\_hit* here and comment out 2 lines:

```
;condition ConsistencyIndicator,14.5,15.5,four;         true if x1,x2,y1 and y2 signals were registered
condition ConsistencyIndicator,62.5,63.5,clean_hit;     true if x1,x2,y1,y2 and z1,z2 signals were registered
;condition four,or,six,clean_hit
```

```
condition sumx,1,10000,sumx
condition sumy,1,10000,sumy
;condition sumy,1,10000,sumw
condition sumx,and,sumy,sumxy
```

This defines a more specific filtering for “clean” events. The boundary parameters in the condition for sumx and sumy conditions should be narrowed according to the actual time peak widths/positions.

```
new
;new hardware
```

This command is defining the type of session but also validates/checks many parameters and coordinate commands on consistency.

```
define1 0,32,1,T1Ch01n,,none,always,T1Ch01n
define1 0,32,1,T1Ch02n,,none,always,T1Ch02n
define1 0,32,1,T1Ch03n,,none,always,T1Ch03n
define1 0,32,1,T1Ch04n,,none,always,T1Ch04n
define1 0,32,1,T1Ch05n,,none,always,T1Ch05n
define1 0,32,1,T1Ch06n,,none,always,T1Ch06n
define1 0,32,1,T1Ch07n,,none,always,T1Ch07n
define1 0,32,1,T1Ch08n,,none,always,T1Ch08n
define1 -2,66,1,ConsistencyIndicator,,none,always,ConsistencyIndicator
define2 0.,9.,1.,n_matrix_x,,0.,8.,1.,n_matrix_y,,none,always,hit statistics
```

These spectra display the number of hits per TDC channels in various representations.

```
define1 -12000,12000,1,T1Ch01S01,T1Ch01S01 (x1 raw),none,always,T1Ch01S01,,true
define1 -12000,12000,1,T1Ch02S01,T1Ch02S01 (x2 raw),none,always,T1Ch02S01,,true
define1 -12000,12000,1,T1Ch03S01,T1Ch03S01 (y1 raw),none,always,T1Ch03S01,,true
define1 -12000,12000,1,T1Ch04S01,T1Ch04S01 (y2 raw),none,always,T1Ch04S01,,true
define1 -12000,12000,1,T1Ch05S01,T1Ch05S01 (z1 raw),none,always,T1Ch05S01,,true
define1 -12000,12000,1,T1Ch06S01,T1Ch06S01 (z2 raw),none,always,T1Ch06S01,,true
define1 -12000,12000,1,T1Ch07S01,T1Ch07S01 (TOF raw),none,always,T1Ch07S01,,true
;define1 -12000,12000,1,T1Ch08S01,T1Ch08S01 (Trigger),none,always,T1Ch08S01,,true
```

These spectra show the “raw” (uncalibrated) values of the first hits in the TDC channels

```
;define1 0,10000,1,AbsoluteEventTime,AbsoluteEventTime [s],none,always,Time since Start,,true
define1 0,0.005,0.00001,DeltaEventTime,DeltaEventTime [s],none,always,Time between Events,,true
define1 0,10000000,1000,EventCounter,,none,always,EventCounter
define1 0,100000,10,RealTriggerRate,,none,always,RealTriggerRate,true
;define2 0,100000,100,AbsoluteEventTime,,0,100000,100,RealTriggerRate,,none,always,Rate (time)
;define2 0,1000000,1000,EventCounter,,0,100000,100,RealTriggerRate,,none,always,Rate (eventnumber)
```

These spectra give information on the trigger (count) rate.

```
define1 -1000,9000,4,raw_sumx,,none,always,raw_sumx (channels),,true
define1 -1000,9000,4,raw_sumy,,none,always,raw_sumy (channels),,true
define1 -1000,9000,4,raw_sumw,,none,always,raw_sumw (channels),,true
define1 -2000,20000,4,raw_sumxyw,,none,always,raw_sumxyw (channels),,true
define1 -5000,5000,4,raw_diffxy,,none,always,raw_diffxy (channels),,true
define1 -6000,6000,4,raw_x,,none,always,raw_x (channels),,true
define1 -6000,6000,4,raw_y,,none,always,raw_y (channels),,true
define1 -6000,6000,4,raw_w,,none,always,raw_w (channels),,true
define2 -6000,6000,10,raw_x,x1-x2 raw,-6000,6000,10,raw_y,y1-y2 raw,none,always,X/Y (u/v) raw (channels),true
define2 -6000,6000,10,raw_x,x1-x2 raw,-6000,6000,10,raw_y,y1-y2 raw,none,clean_hit,X/Y (u/v) raw clean (channels)
;define2 -6000,6000,10,raw_x,u1-u2 raw,-6000,6000,10,raw_w,w1-w2 raw,none,always,u/w raw (channels),true
;define2 -6000,6000,10,raw_y,v1-v2 raw,-6000,6000,10,raw_w,w1-w2 raw,none,always,v/w raw (channels),true
```

These spectra give information on computed (raw) time sum and position coordinates.

```
;define1 -1000,1000,p20,x1,ch1 Time [ns],none,always,ch1 (ns),,true
;define1 -1000,1000,p20,x2,ch2 Time [ns],none,always,ch2 (ns),,true
;define1 -1000,1000,p20,y1,ch3 Time [ns],none,always,ch3 (ns),,true
;define1 -1000,1000,p20,y2,ch4 Time [ns],none,always,ch4 (ns),,true
;define1 -1000,1000,p20,z1,ch5 Time [ns],none,always,ch5 (ns),,true
;define1 -1000,1000,p20,z2,ch6 Time [ns],none,always,ch6 (ns),,true
```

If parameters 1010-1012 = 1 calibrated (ns) time spectra are displayed, as the next spectra for TOF-channel and sums/differences.

```
define1 -1000,1000,p20,TOF,Time (TOF) [ns],none,always,TOF-channel in ns,,true
define1 1,400,p20,sumx,sumx Time [ns],none,always,sumx (ns)
;define1 1,400,0.1,sumx,,none,always,sumx (ns)
define1 1,400,p20,sumy,sumy Time [ns],none,always,sumy (ns)
;define1 1,400,0.1,sumy,,none,always,sumy (ns)
define1 1,400,p20,sumw,sumw Time [ns],none,always,sumw (ns)
;define1 1,400,0.1,sumw,,none,always,sumw (ns)
;define1 1,900,p20,sumxyw,sumxyw Time [ns],none,always,sumxyw (ns)
;define1 -300,300,p20,diffxy,diffxy Time [ns],none,always,diffxy (ns),,true

define1 -100,100,p1015,PosX,PosX [mm],none,always,PosX (mm),,true
define1 -100,100,p1016,PosY,PosY [mm],none,always,PosY (mm),,true

define2 -100,100,p1013,PosX,PosX [mm],-100,100,p1014,PosY,PosY [mm],none,always,PosX/PosY coarse (mm),true
define2 -100,100,p1013,PosX,PosX [mm],-100,100,p1014,PosY,PosY [mm],none,clean_hit,PosX/PosY coarse clean (mm)
;define2 -100,100,p1015,PosX,PosX [mm],-100,100,p1016,PosY,PosY [mm],none,always,PosX/PosY (mm),true
define2 -100,100,p1015,PosX,PosX [mm],-100,100,p1016,PosY,PosY [mm],none,clean_hit,PosX/PosY clean (mm)
;define2 -50,50,p1017,PosX,PosX [mm],-50,50,p1018,PosY,PosY [mm],none,clean_hit,PosX/PosY fine clean (mm)
```

If the parameters 1010 to 1012 are set properly for the delay-line in use the spectra with *PosX* and *PosY* as coordinates show position values in mm. Specific conditions remove incompletely registered events and produce “clean” images. The condition *clean\_hit* may be replaced by a more refined condition (i.e. on the time sums).

```
definemulti Overview,PosX/PosY coarse clean (mm),sumx (ns),sumy (ns),TOF-channel in ns
```

gives an overview of several spectra of interest in a multi-spectrum view  
Control spectra as the following may be found useful for trouble-shooting

```
;define2 -100,100,p1013,PosX,PosX [mm],-100,1000,1,sumx,sumy [ns],none,clean_hit,PosX/sumx (condsumy)
;define2 -100,100,p1014,PosY,PosY [mm],-100,1000,1,sumy,sumy [ns],none,clean_hit,PosY/sumy (condsumx)

;define1 -200,200,1,reflection_in_MCP,dt [ns],none,always,reflection in MCP signal (ns)

;define1 -200,200,1,reflection_in_x1,dt [ns],none,always,delay-line reflection in x1 (ns)
;define1 -200,200,1,reflection_in_x2,dt [ns],none,always,delay-line reflection in x2 (ns)
;define1 -200,200,1,reflection_in_y1,dt [ns],none,always,delay-line reflection in y1 (ns)
;define1 -200,200,1,reflection_in_y2,dt [ns],none,always,delay-line reflection in y2 (ns)
;define1 -200,200,1,reflection_in_z1,dt [ns],none,always,delay-line reflection in z1 (ns)
;define1 -200,200,1,reflection_in_z2,dt [ns],none,always,delay-line reflection in z2 (ns)
```

Examples for empty spectra definition (for spectra computations or projections) are

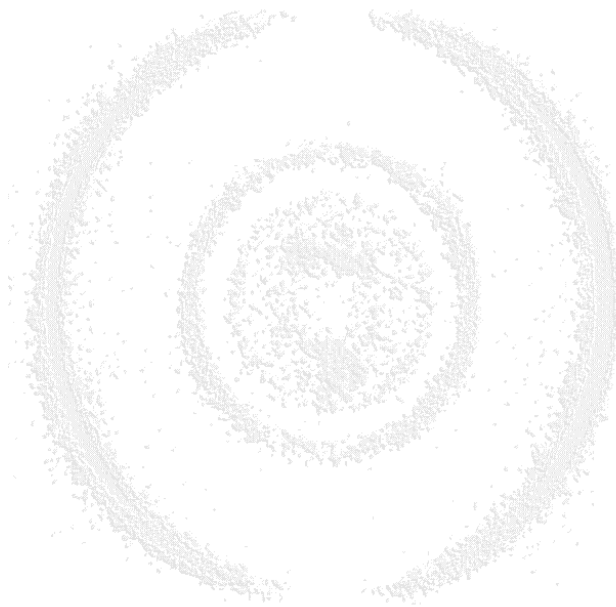


```
;define1 -100,100,1,none,,none,always,Empty 1D  
;define2 -100,100,1,none,,-100,100,1,none,,none,always,Empty 2D
```

Now the data acquisition is started:

```
start  
;show status  
view 10
```

Note that the command definitions here shall only allow a “quick start” for the use of our delay-line detectors. More advanced data treatments like defining new (computed) coordinates to the analysis can be done by additionally modifying the DAn Dll module using a MS C++ compiler of Visual Studio 2011 or above. Please refer to the **CoboldPC** manual for details. Also, there is a “zero-level” of operating for the recent **CoboldPC** 2011 version, allowing to address the **CoboldPC** commands by a “remote control” scripting language. Again, for details refer to the **CoboldPC** manual.



## 5 High voltage Supplies

Safe and high-performance operation of the detector operation of the **RoentDek** detectors requires adequate high voltage supplies and auxiliary passive bias units. In the following the standard units are described. If you have received a different model please refer to the respective manual.

### 5.1 The HV 2/4 dual High Voltage supply module

The **RoentDek** 2x4kV Power Supply is especially designed for the use of biasing multi-channel-plate detectors, featuring low-ripple and regulated current limitation and protection. It is to be powered by a NIM crate or the **RoentDek** SPS2 (mini) mains adapter (**RoentDek** BIASET3). It is also possible to externally supply the operation voltage using the 9 pin socket on the rear side panel, supplying the voltages (ripple < NIM-crate standard), according to Table 5.1 (see below).  $U_c$  of  $\pm 24V$  (800mA) and  $\pm 6V$  (100mA) DC have to be provided to power the module. The “N24” version of the supply requires only the  $\pm 24V$ , see next section.

The switches on the side panel will set the respective channels to negative or positive output polarity, indicated by an LED on the front panel. Only change polarity when the power is off.

If a channel of the power supply is switched on (indicated by an LED), and the “DAC” switch is set to upward position, the 10-turn potentiometers at the front panel can be used for manual voltage setting  $U_a$  (10 turns correspond to 4000V, linear progression). This is the recommended procedure for operating the **RoentDek** detectors.

The voltages can also be ramped externally with an analog voltage input to the Lemo-sockets on the rear panel (10V analog input corresponds to maximum voltage output, linear progression). For this the “DAC” switch must be set to “DAC”. Please contact **RoentDek** for adequate remote DC level controls (e.g. the **USB-I/O** modules).

The A/B switch will set the display to channel A or B, the V/I switch will enable voltage or current reading of the set channel. The accuracy of the reading is within a few volts and a few  $\mu A$  (typically  $1\mu A$ ), respectively.

The maximum current delivered is 3mA, the maximum voltage is  $\pm 4kV$ . Both can be restricted in 10% steps from 0.3mA (or 400V) to 3mA (or 4000V) which corresponds to 100%. \* Usually the current limiter should set to 10%, i.e. 0.3mA when using it with a **RoentDek** MCP detector (exception: biasing via a HVT device).

If the trip protection switch is set to “enable kill” the voltage will be turned off in case of over-current (e.g. after a spark) or over-voltage (indicated by a flash of the “ERROR” LED), according to the settings of  $V_{max}$  and  $I_{max}$ . In the other switch position the module will try to engage the set voltage again, however it will trip once more if the limit is reached again and continue this cycle. **This is an unfavorable operation condition if the tripping is caused by detector sparks and may cause damage.**

In case of an error turn down the voltage and turn the module off and/or engage the enable switch again after verifying a proper state of your hardware. A TTL signal (“high”) on the “inhibit” input will also deactivate the voltage, like the event of an over-current, according to the position of the “enable kill” switch.

The hardware ramp speed is 500V/sec max. (power switch on/off).

*The safest operation mode for MCP is the “enable kill” position. If the current limitation is set low and the switch is on this position it can happen that an error is indicated when starting to increase the voltage on a certain detector part, although no problem of the hardware actually exist. This is due to the loading current of capacitors in the power supply itself or in the signal decoupling circuits. In that case set the switch to the other direction when starting to increase voltage. You may switch to the “enable kill” position later after the voltage setting is finished.*



Figure 5.1: 2x4kV Power Supply (front panel)

\* **RoentDek** can also supply a 6kV and 8kV version (1mA) of this module or modules with even higher voltage ratings. A “pseudo-floating” power supply is also available. Please refer to the separate manual if you have received such a module.

On the rear panel on some modules you find a 9-pin socket where the external power cable for the **RoentDek** amplifier modules of type **DLATR6** and **ATR19-2** can be powered (only if labeled accordingly, see Figure 5.3, not for N24 version. N24 and non-standard modules may not have this 9-pin socket or the socket is used for digital remote control. Please observe the label on your specific module).

**Warning: the HV output of this power supply can be hazardous if not properly operated. Never operate the module with open housing. RoentDek denies any responsibility for accidents with their products and is protected by German laws. If you need special instructions how to handle high voltage power supplies please contact RoentDek.**

**Further specifications:**

Operation temperature:	0 ... +50°C
Storing temperature*	-20 ... +60°C
Ripple (peak-to-peak)	< 50mV
Stability	$\Delta U_a < 2 \times 10^{-4}$ or $5 \times 10^{-5}$ of $\Delta U_c$
Temperature coefficient	$< 1 \times 10^{-4}/^\circ\text{C}$

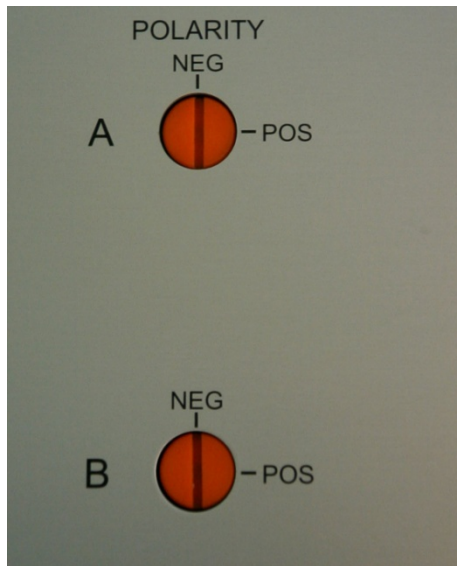


Figure 5.2: 2x4kV Power Supply (side-panel)



Figure 5.3: 2x4kV Power Supply (rear-panel)

**Changing the Polarity of Channel A and/or B**

To change the polarity of either channel, A or B, locate the “red knobs” on the left side-panel (see Figure 5.2) and place the module flat on a table showing the side-panel. Gently adjust the slit of the “red knob” to the desired polarity using either an adequate screwdriver or a coin. Please make sure that the screwdriver is not tilted. **Do not press on the knob! Do not use force!** The channel is adjusted if you hear and feel the lock in place.

Pin1/2	ground	Pin3	open (reserved for -5.2V on some modules)
Pin4	+12V	Pin5	- 6V
Pin6	- 24V	Pin7	+24V
Pin8	+6V	Pin9	- 12V

Table 5.1: Pin assignments of standard **RoentDek** 9-pin sub-D voltage connector.

## 5.2 The BIASET3 with SPS2(mini)

The **BIASET3** consists of the 90-250VAC main power supply **SPS2(b)** and 1 to 4 units of **HV2/4** (or **HV2/6**, **HV2/8**) modules (see Chapter 5.1) as a standalone power supply solution without the need for a NIM bin. It can also incorporate single channel high voltage (HV) modules like the **HV1/4** or any of the **EHQ 1xxx** series earlier **BIASET2** product). The **BIASET3** includes a stand for up to 4 HV modules. The HV modules and the **SPS2(b)** are interconnected via 9-pin sub-D cables (included) on the rear panels\*.



Figure 5.4: BIASET3 with SPS2 and one HV2/4 module (corresponds to BIASET3-2)

The **SPS2** mains adapter provides power via standard 9-pin sub-D cables for up to two HV modules or via twin-9-pin sub-D cables for up to four HV modules. It measures about 130\*130mm with a depth of approximately 250mm (extra 100mm free depth are needed for the cables on the rear panel).

The **SPS2** can be mounted to a 3 HU 19" rack (occupies 24 width units) or can be used as a table-top unit. The unit requires sufficient airflow and an ambient temperature <40°C. A spare main fuse (250V 4A, slow) is supplied in the AC-input plug.

For instructions how to replace the fuse please refer to the **RoentDek ATR19** manual see "SPS1 module".

\* The output from the **SPS2(b)** cannot supply operation voltages for the **(N)DLATR** or **FAMP/CFD** modules.





Figure 5.5: SPS2 front and rear panel with connection cable to HV2/4 module (not shown).

High voltage modules of the type “N24” and **EHQ 1xxx** (e.g. **HV1/4**) can alternatively be supplied via the **SPS2mini** mains adapter which delivers only  $\pm 24V$ . If you want to purchase a mains adapter for an existing **HV2/4** modules verify of which type it is. The “N24” units can be recognized by the respective label on the front panel:



Figure 5.6: SPS2mini mains adapter (left) and the specific label (red arrow) on the front side of a “N24”- type HV2/4 module which can be powered by it. The N24-type HV modules can also be operated with old-type NIM-crates that does not supply the  $\pm 6V$ .

### 5.3 BA3 battery unit

It is usually sufficient to operate the delay-line with a voltage difference of 20 to 50V between the reference and the signal wires. To supply this constant voltage offset between the wires a battery can be used. The **RoentDek BA3** battery pack provides this offset with values between 35 and 40V (nominally 36V, without load 38 - 39V).

If you want to use the **BA3** for supplying the wire potentials you need to connect the SHV output “HV +36V” to the  $U_{\text{sig}}$  input of the **FT12/16-TP** plug and the other SHV output “HV” with the  $U_{\text{ref}}$  input. The desired potential for the reference wire ( $U_{\text{ref}}$ ) must be supplied to the SHV input. “HV input” of the **BA3**'s opposite side.

Note, that the battery is not discharged during normal operation as no current is flowing between  $U_{\text{ref}}$  and  $U_{\text{in}}$ . Even in the presence of a short on the delay-line anode, there is still a  $1\text{M}\Omega$  resistance between the poles of the internal battery pack. The lifetime of the battery pack is therefore very long (several years). The individual batteries are standard 12V cells which can be found for example in camera shops. If you need help in replacing the battery please contact **RoentDek**.

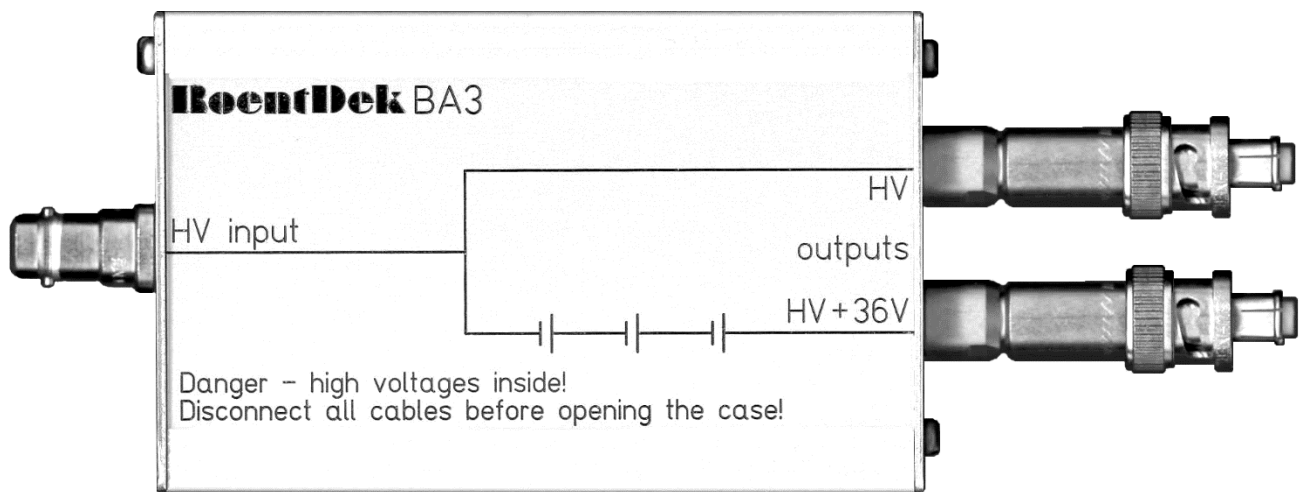
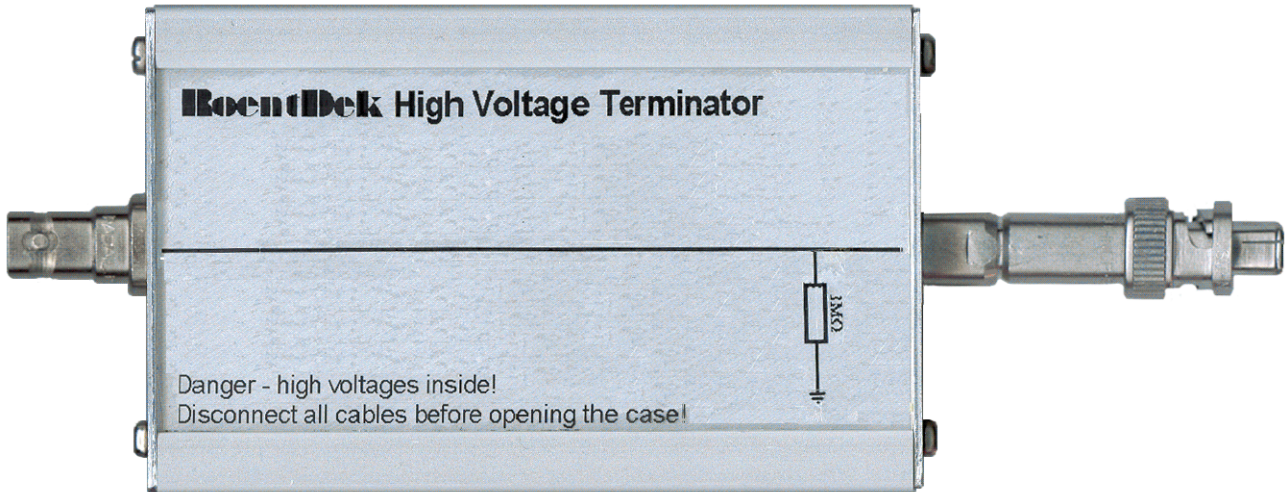


Figure 5.7: **RoentDek BA3** battery box. The voltage input is on the left side, the output connectors (here as reserve SHV) on the right side. The input voltage is routed to the upper voltage output (for  $U_{\text{ref}}$ ) and produces with the internal battery pack the signal voltage  $U_{\text{sig}} = U_{\text{ref}} + 36\text{V}$  (nominally) on the lower output connector.

## 5.4 HVT and HVT4 High Voltage Terminators

If the micro-channel plate stack shall be biased with the same polarity on both sides (e.g. positive, for electron detection), most high voltage power supplies' control circuits cannot stabilize the low bias setting: as one supply is ramped to a higher bias, e.g. on MCP back side, it will “pull away” the bias of the other MCP side in spite of a low-voltage setting on the dial. This is due to the coupling of the supplies via the MCP stack resistance  $R_{MCP}$ . On the **RoentDek HV2/4** and similar units the effect can directly be observed on the voltage display (when the set voltage is zero or low enough).

This can be avoided by “terminating” the low-bias output to “ground” via a well-selected resistor  $R_{HVT}$ , e.g. of  $1M\Omega$ . For this purpose **RoentDek** can provide a passive so-called **High Voltage Terminator** box **HVT**. If such a unit is placed in the cable connections between the (lower-bias) voltage supply output and the MCP bias input the “pull-away” effect is restricted to a low-enough value (given by Equation 5.1) and it is then possible raising the bias to the desired value.



**Figure 5.8: High Voltage Terminator**  
Here with  $1M\Omega$  resistor to ground and reverse SHV connector on one side.

In the following it is assumed that the MCP stack's polarity shall be positive on both sides (for electron/negative particle detection). Usually the MCP bias is connected via signal decoupling/terminating circuits containing blocking resistors  $R_{Df}$  (at MCP front and  $R_{Db}$ \* (at MCP back). When introducing a **High Voltage Terminator** the following potential will be found at MCP front side:

$$U_{MCP\ front} = U_{MCP\ back} \times \frac{R_{HVT} + (R_{Df})}{R_{HVT} + R_{MCP} + R_{Db} + (R_{Df})} \quad \text{Equation 5.1}$$

Often  $R_{Df}$  can be neglected, likewise, the terms in parentheses are usually negligible in this formula.

The standard version of the **HVT** contains a  $1M\Omega$  resistor to “ground” and is optimized for electron detection purposes with MCP front potential near +200V or higher. For typical MCP stack resistances  $> 20M\Omega$  the minimum MCP front voltage due to the “pull-away” effect will be  $< 200V$  and can actively be raised up to 1300V (maximum rating) with a high voltage supply. Note, that the current to be drawn from the power supply may exceed its capability. A **RoentDek HV2/4** can only go up to 1000V when driving a  $1M\Omega$  resistor (less, if current limiter settings are engaged). For high potentials it is advisable adding another  $1M\Omega$  in series, either by using a second **HVT**, or supplemented inside the **HVT** (separate resistors are available from **RoentDek**). It is important to note that the effective MCP front potential may still differ from the set voltage in case of a non-negligible value of  $R_{Df}$ . Please refer to the **RoentDek** detector manual for determining this effect. The **HVT4** version contains a  $10M\Omega$  resistor rated for up to 4kV. It is typically used for applications with MCP front at a high negative potential (e.g. -6kV via an SHV feedthrough and a special high voltage HFST) when the MCP back side is also at a negative potential (above 1 kV). In this case, “ $U_{MCP\ front}$ ” / “ $U_{MCP\ back}$ ” and  $R_{Df}$  /  $R_{Db}$  must be swapped in the above considerations and in Equation 5.1. The **High Voltage Terminator** is in this case placed between the MCP back bias input and the corresponding high voltage supply output.

\* In the **RoentDek FT12TP** and **HFSD/HFST** decoupler circuits  $R_{Db}$  is  $1M\Omega$  and  $R_{Df}$  either  $1M\Omega$  or  $10k\Omega$ .



It is also possible changing the internal resistor to a value so that the desired voltage on MCP front (or back) is generated only by applying the bias on the other MCP side (passive **HVT** use). The corresponding value of  $R_{HVT}$  can be derived from Equation 5.1.

**Important:** only use resistors with sufficient voltage and power rating.

If you need help in determining  $R_{HVT}$  for passive **HVT** use or finding adequate resistors please contact **RoentDek**.

For applications with demands for slow heavy ion or negative ion detection please contact **RoentDek** for special detector mounting, signal decoupling and high voltage supply rated up to 10kV.

## 5.5 HVZ voltage divider unit

The **RoentDek HVZ** is a passive voltage divider box generating intermediate potentials in steps of 56V (+/-10%) for all delay-line anode contacts and MCP back side of **RoentDek** delay-line detector (and 39V nominally between the reference and signal wire). It has one high voltage input socket (SHV) labeled “HV In” and four SHV output sockets for providing bias to the MCP back side ( $U_{MCP\ back}$ ), “Holder” ( $U_H$ ) and the delay-line anode wires ( $U_{ref}/U_{sig}$ ). Thus, only two potentials are to be provided from high voltage supplies for biasing all detector contacts:  $U_{sig}$  (via the “HV In” socket) and  $U_{MCP\ front}$ , i.e. the MCP front potential. The latter may also be produced by “terminating” MCP front via a **RoentDek HVT** (see Chapter 5.4). Other detectors like the **RoentDek DET40/75** can also be biased in this way using the **HVZ**.

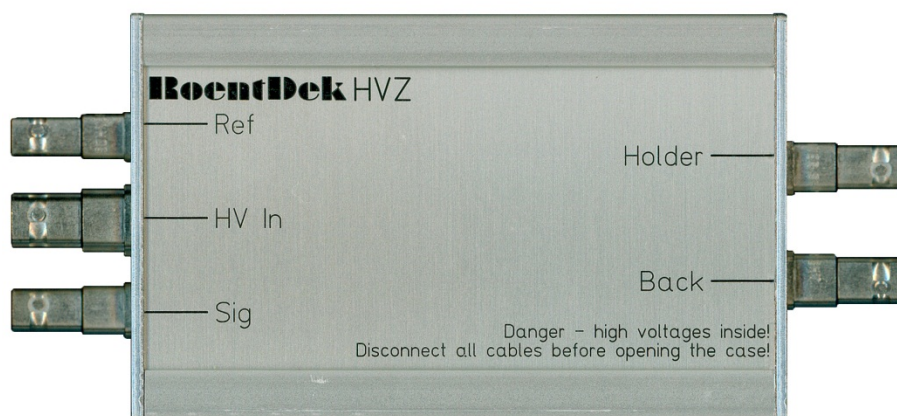


Figure 5.9: HVZ with the SHV connector sockets.

Using the **HVZ** for detector bias is equivalent to applying a resistor divider chain for this purpose. The **HVZ** has the advantage that the relative voltages set between MCP back, Holder and delay-line wires do not depend on the absolute detector bias with respect to ground (i.e. are independent from the choice of MCP front potential). This insures the proper voltage difference between the MCP back side and the anode (wires) and at least near-optimal voltage setting for the **DLD**'s or **Hex**' “Holder” bias: its intermediate potential can be selected in steps of 56V (nominally) by jumper settings. A battery box is not needed when using the **HVZ**, however, optional jumper positions also allow bias settings for the wires through a **BA3** or other floating battery units. The **BA3** may also be used in combination with the **HVZ** for increasing the voltage difference between anode wires and MCP back (see below).

Inside the **HVZ** a total voltage drop of up to a maximum set value (i.e. 260V) is generated as soon as appropriate electrical current flows through the unit from the input SHV socket labeled “HV In” to the “Back” socket. This current can only flow if there is an according potential difference maintained between the sockets and the current is drained by a resistor load connected to the “Back” socket. This resistor may be a microchannel plate stack: The **HVZ**' “Back” socket is physically connected to the MCP stack's back side input and the MCP stack's front side must be kept at a less positive potential than the bias on “HV In”.

It is important to note that the relation between the current through the MCP stack and the voltage between “HV In” and MCP front potentials is not linear, as long as it is lower than the **HVZ**' set value. For calculating the nominal MCP back potential (i.e. on the voltage input of a signal decoupler on MCP back contact) the set voltage needs to be subtracted from the



“HV In” bias. This is important to note when considering the effective voltage across the MCP stack and when calculating the MCP resistance from the current flowing through the stack.

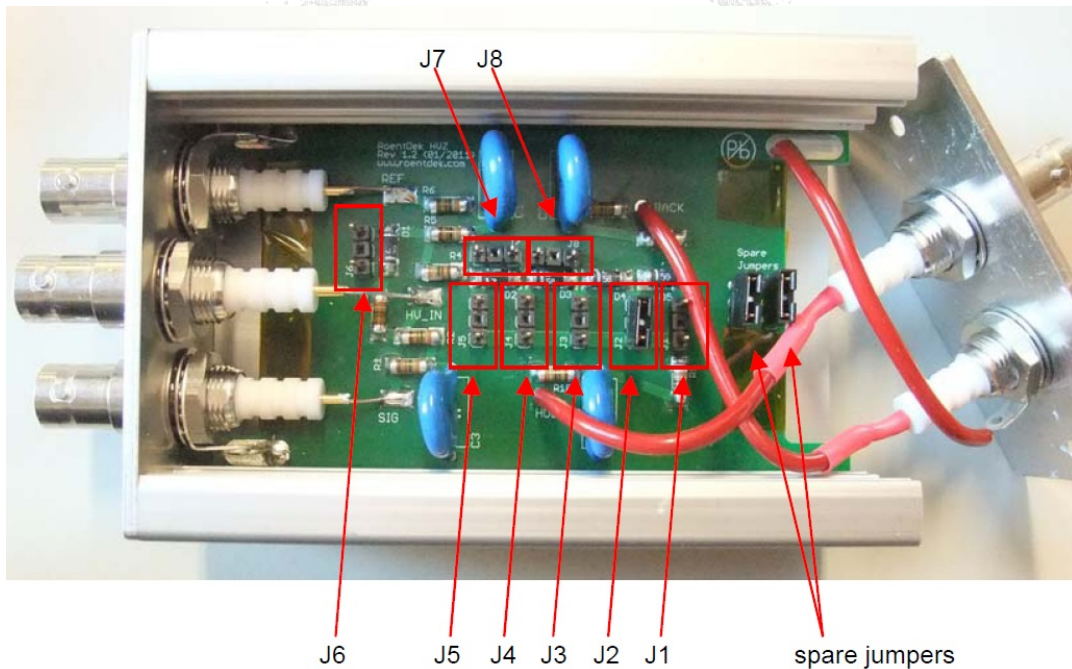
It is important to insure that the voltage across the **HVZ** is never inversed and “HV In” > “Back” > MCP front bias according to normal detector operation. The use of the **HVZ** requires the “Back” output always being connected to the MCP back side when applying voltage. Never directly short any of the **HVZ** outputs to ground in order to force this potential to zero. This may cause severe damage to the **HVZ** circuit.

For operation in the standard configuration (as shipped) with all outputs sockets “Ref”, “Sig”, “Holder” and “Back” connected to the detector ( e.g. via the **RoentDek FT12TP** or **FT16TP** decoupling circuits) the bias applied to “HV In” is directly connected with the “Sig” output socket, i.e. for the signal wire potential ( $U_{sig}$ ). “Ref” output provides the 36V more negative  $U_{ref}$  potential (i.e. with the same potential difference as provided by a **RoentDek BA3** unit).

As described above the “Back” output provides the bias  $U_{MCP\ back}$  which is nominally 260V more negative with respect to “HV In”. However, the effective bias on MCP back side may be lower (more negative) due to the voltage drop across the blocking resistor in the signal decoupling circuit (typically  $1M\Omega$ , please refer to the delay-line detector manual for determining this additional bias shift).

The bias pickup from the **HVZ** for the Holder potential ( $U_H$ ) can be adjusted between  $U_{ref}$  and  $U_{MCP\ back}$  in steps of 56V by selecting a jumper position (default:  $U_H = U_{MCP\ back} + 56V$ ). \*

Before opening the **HVZ**, make sure to reduce all voltages to zero and then disconnect all cables from the **HVZ**. When removing the cables while still on high potential, there might still be hazardous voltages stored within the **HVZ**'s capacitors



**Figure 5.10: HVZ with jumper options.**

The standard settings as displayed in Figure 5.10 (no jumpers on J6 to J8, one jumper on at positions J1 to J5) can be modified:

- J1 to J5: jumper positions determining “Holder” potential. Only one jumper shall be set on J1 to J5.
- |               |  |                              |
|---------------|--|------------------------------|
| jumper at J1: | Holder and Back outputs provide the same potential | $U_H = U_{MCP\ back}$        |
| jumper at J2: | default  | $U_H = U_{MCP\ back} + 56V$  |
| jumper at J3: |  | $U_H = U_{MCP\ back} + 112V$ |

\* Note that the detector’s Holder potential is not necessarily to be supplied through the **HVZ**. It can also be drawn from an independent high voltage supply if linearity near the MCP edge needs optimization.

jumper at J4:  
jumper at J5:

$$U_H = U_{\text{MCP back}} + 168\text{V}$$
$$U_H = U_{\text{MCP back}} + 224\text{V} (= U_{\text{ref}})$$

Changing this jumper position from the default setting can be beneficial for modified detector geometry (MCP holding plate at a non-standard position) or if the effective MCP back potential is significantly shifted (use J1 position).

J7 and J8: placing a jumper on J7 or on J7 *and* J8 reduces the total voltage drop across the **HVZ** by 56V or 112V, respectively.

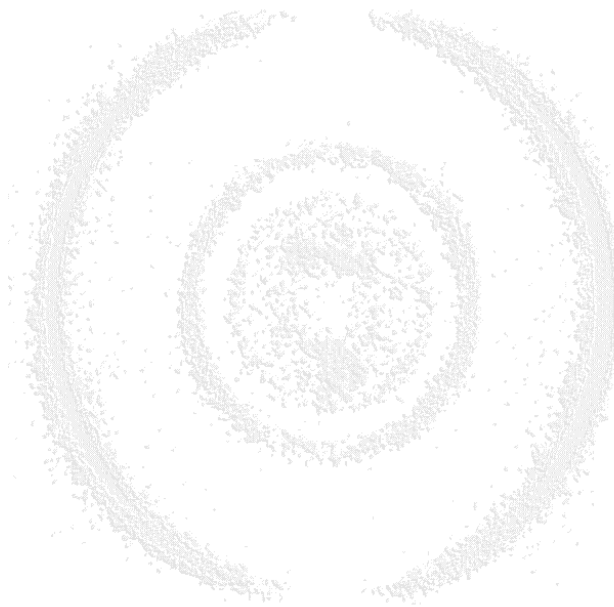
jumper at J7: positions J5 out of use, jumper at J4 provides  $U_H = U_{\text{MCP back}} + 168\text{V} = U_{\text{ref}}$ .

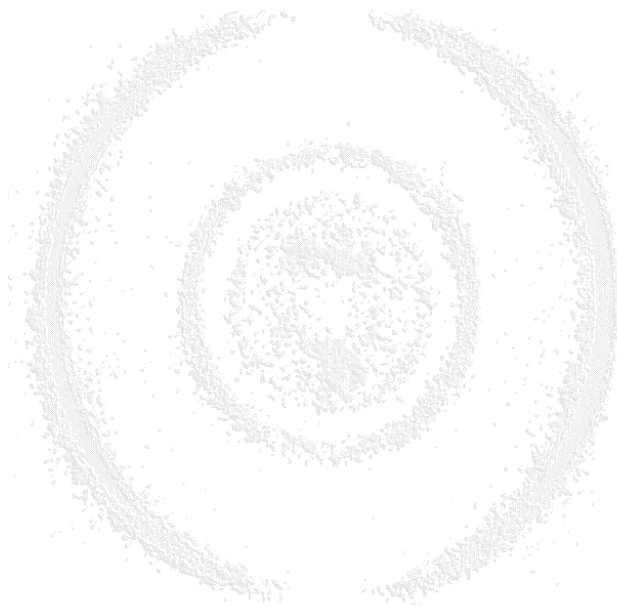
jumpers at J7 and J8: positions J5 and J4 out of use, jumper at J3 provides  $U_H = U_{\text{MCP back}} + 112\text{V} = U_{\text{ref}}$ .

These options can be beneficial if the effective MCP back potential is strongly shifted, or a lower anode voltage shall be used for some reason (i.e. different anode type). If a larger voltage drop (beyond 224V between  $U_{\text{ref}}$  and  $U_{\text{MCP back}}$ ) is required it is possible placing two **HVZ** units in series or combining a **HVZ** with a *BA3*.

J6: no jumper:  $U_{\text{sig}} = U_{\text{ref}} + 36\text{V}$  (default)  
if a jumper is set on J6, both Ref and Sig outputs provide the same potential as “HV in”.

This option allows using a **BA3** or other floating battery device for producing the voltage difference between “ref” and “sig” for a delay-line anode.





## Appendix: (MCP's):

# STORAGE, HANDLING and OPERATION of MICROCHANNEL PLATES

from Galileo Corp.

### STORAGE

Because of their structure and the nature of the materials used in manufacture, care must be taken when handling or operating MCPs. The following precautions are strongly recommended: Containers in which microchannel plates are shipped are *not suitable* for storage periods exceeding the delivery time. Upon delivery to the customer's facility, microchannel plates must be transferred to a suitable long term storage medium.

- Dessicator type cabinets which utilize silica gel or other solid dessicants to remove moisture have been proven *unacceptable*.
- The most effective long-term storage environment for an MCP is an oil free vacuum.
- A dry box which utilizes an inert gas, such as argon or nitrogen, is also suitable.

### HANDLING

- Shipping containers should be opened only under class 100 Laminar flow clean-room conditions.
- Personnel should always wear clean, talc-free, class 100 clean-room compatible, vinyl gloves when handling MCPs. No physical object should come in contact with the active area of the wafer. The MCP should be handled by its solid glass border using clean, degreased tools fabricated from stainless steel, Teflon™ or other ultra-high vacuum-compatible materials. Handling MCPs with triceps should be limited to trained, experienced personnel.
- MCPs without solid glass border should be handled *very* carefully with great care taken to contact the outer edges of the plate *only*.
- All ion barrier MCPs should be placed in their containers with the ion barrier facing down.
- The MCP should be protected from exposure to particle contamination. Particles which become affixed to the plate can be removed by using a single-hair brush and an ionized dry nitrogen gun.
- The MCP should be mounted only in fixtures designed for this purpose. Careful note should be taken of electrical potentials involved.
- **CAUTION:** Voltages must not be applied to the device while at atmospheric pressure. Pressure should be  $1 \times 10^{-5}$  bar or lower at the microchannel plate before applying voltage. Otherwise, damaging ion feedback or electrical breakdown will occur.

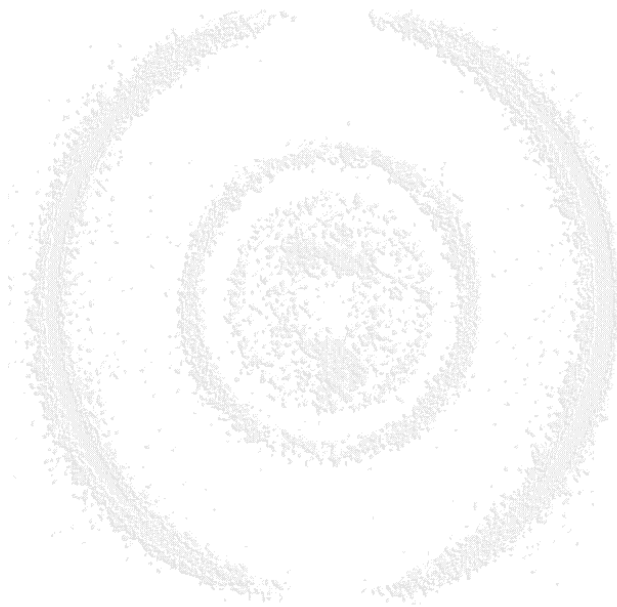
### OPERATION

- A dry-pumped or well-trapped/diffusion-pumped operating environment is desirable. A poor vacuum environment will most likely shorten MCP life or change MCP operating characteristics.
- A pressure of  $1 \times 10^{-6}$  bar or better is preferred. Higher pressure can result in high background noise due to ion feedback.
- MCPs may be vacuum baked to a temperature of 480°C (*no voltage applied*) and operated at a maximum temperature of 350°C.

When a satisfactory vacuum has been achieved, voltages may be applied. It is recommended that this should be done slowly and carefully. Current measuring devices in series with power supplies aid in monitoring MCP behavior. Voltage drop across the  $\Omega$  meter should be taken into consideration when calculating the applied voltage.

- Voltage should be applied to the MCP in 100V steps. If current is being monitored, no erratic fluctuations should appear. If fluctuations do appear, damage or contamination should be suspected and the voltage should be turned off. The assembly should then be inspected before proceeding.
- Voltage across single thickness MCPs should not exceed 1000V. Higher potentials may result in irreversible damage.





## List of Figures

FIGURE 1.1: OPERATION PRINCIPLE OF THE DELAY-LINE-ANODE, LEFT PICTURE FROM: SOBOTTKA AND WILLIAMS IEEE TS-35 (1988) 348 .....	9
FIGURE 1.2: TYPICAL IMAGING/TIMING PERFORMANCE OF A DLD40 DETECTOR. THE DETECTOR (SHADED BY A MASK) WAS IRRADIATED WITH $\alpha$ -PARTICLES. SIMILAR OR BETTER RESULTS CAN BE ACHIEVED WITH ADEQUATE READ-OUT ELECTRONICS. TEMPORAL RESOLUTION IS SIGNIFICANTLY BETTER THAN THE LOCAL TIME SUM WIDTH (SEE RIGHT PICTURE) WHICH INDICATES AN UPPER LIMIT. ....	10
FIGURE 1.3: ORIENTATION OF THE REAR CERAMIC RING ON THE DELAY-LINE ASSEMBLY (DLD40, DLD80). FOR HEX80/HEX75 THE ORIENTATION IS SIMILAR, BUT THERE IS ONLY ONE PAIR OF FLAT "SHIELDS". ....	11
FIGURE 1.4: CABLES FOR HOLDER AND WIRES ON DLD40, DLD80 AND HEX80. THE FOUR M2 RODS AND THE MCP HOLDER PLATE ARE ON THE SAME "HOLDER" POTENTIAL AS THE DELAY-LINE ANODE BODY. THE CABLE CAN BE CONNECTED ANYWHERE ON THESE PARTS. ....	13
FIGURE 1.5: ORIENTATION OF X AND Y POSITION TERMINALS ON ANODE VIEWED FROM THE REAR SIDE, THE OUTER DELAY LINE WIRES IN THIS POSITION THE SLIDING SHIELDS ARE RECOMMENDED TO BE PLACED LEFT AND RIGHT ON THE (INNER) Y-LAYER SIDE.....	13
FIGURE 1.6: REAR VIEW OF A HEXANODE WITH SUGGESTED CABLE CONNECTION .....	13
FIGURE 1.7: CONNECTIONS TO A CERAMIC RING. LEFT: CABLE CLAMPED TO A "FRONT" RING (MCP SIDE VISIBLE). MIDDLE/RIGHT: CABLE CLAMPED TO A BACK RING WITH 3MM LUG, COUNTERSUNK M2 SCREW AND SPECIAL M2 NUT. ....	14
FIGURE 1.8: FREE-STANDING MESH MOUNTED TO THE MCP FRONT RING (LEFT: FRONT SIDE, RIGHT REAR SIDE OF THE FRONT RING). ....	14
FIGURE 1.9: RECOMMENDED RING ORIENTATIONS ON A DLD40 ASSEMBLY (DLD80 & HEX80 SIMILAR). LEFT PICTURE: CABLE CONNECTION OF THIS TYPE WITHOUT LUG. CABLE CONNECTION PADS MUST REST IN THE RECESSED PARTS OF THE HOLDER PLATE NEAR THE DIAGONAL. RIGHT PICTURE: THE ASSEMBLED MCP STACK WITH RECOMMENDED ORIENTATION. HERE, LUGS WITH CRIMPED WIRES CRIMPED ARE USED. PLEASE FOLLOW THE NEXT FIGURES/DIRECTIONS TO ACHIEVE SUCH A DETECTOR MOUNTING .....	15
FIGURE 1.10: ASSEMBLY OF MCP-STACK - STAGE 1 (DLD40, DLD80 & HEX80).....	15
FIGURE 1.11: ASSEMBLY OF MCP-STACK - STAGE 2A (DLD40, DLD80 & HEX80) .....	16
FIGURE 1.12: ASSEMBLY OF MCP-STACK - STAGE 2B (DLD40(2), DLD80 & HEX80/HEX75).....	16
FIGURE 1.13: ASSEMBLY OF MCP-STACK - STAGE 3-1 (DLD40, DLD80 & HEX80) .....	16
FIGURE 1.14: ASSEMBLY OF MCP-STACK - STAGE 3-2 (DLD40, DLD80 & HEX80) .....	17
FIGURE 1.15: ASSEMBLY OF MCP-STACK - STAGE 3-3 (DLD40, DLD80 & HEX80) .....	17
FIGURE 1.16: ASSEMBLY OF MCP-STACK - STAGE 3-4 (DLD40, DLD80 & HEX80) .....	17
FIGURE 1.17: MCP STACK WITH SPRING CLAMP FOR THE MCP BACK CABLE (DLD40, DLD80 & HEX80).....	17
FIGURE 1.18: ASSEMBLY OF MCP-STACK - STAGE 4 (DLD40 & DLD80).....	18
FIGURE 1.19: HEXANODE WITH HOLDER.....	18
FIGURE 1.20: HEXANODE WITH MOUNTED MCP-STACK .....	18
FIGURE 1.21: REAR METAL PLATE WITH ONE MCP (DLD120 AND HEX120) .....	19
FIGURE 1.22: ASSEMBLY OF MCP-STAGE 2 (DLD120 AND HEX120).....	19
FIGURE 1.23: ASSEMBLY OF MCP-STACK - STAGE 3-1 (DLD120 AND HEX120) .....	20
FIGURE 1.24: ASSEMBLY OF MCP-STACK - STAGE 3-2 (DLD120 AND HEX120) .....	20
FIGURE 1.25: ASSEMBLY OF MCP-STACK - STAGE 3-3 (DLD120 AND HEX120) .....	20
FIGURE 1.26: ASSEMBLY OF MCP-STACK - STAGE 4 (DLD120 AND HEX120) ONLY FOR OLD SYSTEMS .....	21
FIGURE 2.1: SKETCH OF THE DETECTOR WITH MOUNTING FLANGE (ONLY FLANGE MOUNTING OPTION, HERE: FT12TP/100). FOR CONNECTING A HEXANODE, THE SAME 12-PIN FEEDTHROUGH IS USED AND AN ADDITIONAL SET OF AT LEAST 3 MHV OR SHV FEEDTHROUGHS (E.G. THE FT4) IS NEEDED FOR CONNECTING THE MCP FRONT, MCP BACK, HOLDER (AND OPTIONALLY A MESH). ....	24
FIGURE 2.2: CF200 FLANGE WITH TWO CF35 PORTS FOR MOUNTING A HEX80 DETECTOR. IT IS RECOMMENDED TO FIX THE FT12 12-PIN FEEDTHROUGH ON THE CENTER PORT IN AN ORIENTATION THAT THE GROOVE POINTS PERPENDICULAR (OR AS CLOSE TO THAT AS POSSIBLE) TO THE DIRECTION OF THE OFF-CENTER PORT. THIS AVOIDS SPATIAL CONFLICTS THAT CAN OCCUR FOR CERTAIN ITEM COMBINATION IN THE FT16TP PRODUCT PACKAGE.....	24
FIGURE 2.3: PIN NUMBERS AT THE FT12 FLANGE (THE AIR-SIDE GUIDING GROOVE POINTS UPWARDS) AND CABLE CONNECTIONS. ....	25
FIGURE 2.4: FT12TP PLUG WITH SWITCH FOR FRONT (F) AND BACK (B) MCP PICKUP. THE HOLE IN THE RING CASE ALLOWS ACCESS TO THE IN-LINE POTL.....	27
FIGURE 2.5: FT12TPHEX PLUG WITH SQUARE CASE .....	27

FIGURE 2.6: RESPONSE OF A DELAY-LINE TO A SIGNAL PASSING THROUGH A FT12TP(HEX) PLUG. UPPER TRACE: INPUT SIGNAL, MIDDLE TRACE: OUTPUT SIGNAL FROM THE OPPOSING TERMINAL OF THE SAME LAYER, LOWER TRACE: OUTPUT FROM A TERMINAL OF ANOTHER LAYER (25X ENLARGED). THE LEFT MARKER DEFINES THE INPUT TIME REFERENCE. FURTHER EXPLANATIONS SEE TEXT. .... 28

FIGURE 2.7: SINGLE HF-SIGNAL-DE-COUPLER PLUG (HFSD) WITH LEMO OUTPUT AND IN-LINE POTI ..... 30

FIGURE 2.8: TYPICAL AMPLIFIED PULSE SHAPE FROM THE MCP AFTER PROCESSING WITH AN INVERTING AMPLIFIER (HERE: ANALOG MONITOR OUTPUT FROM A **ROENTDEK** ATR19 MODULE). .... 32

FIGURE 3.1: THE ATR19 MODULE ..... 35

FIGURE 3.2: TOP LID OF ATR19 WITH HOLES TO REACH THE GAIN POTENTIOMETERS. TURNING CLOCKWISE: AMPLIFIER GAIN IS INCREASED, TURNING COUNTER CLOCKWISE: GAIN IS DECREASED (FOR ATR19-2 REFER TO CHAPTER 3.6) ..... 36

FIGURE 3.3: ATR19 WITH INPUT SETTINGS FOR DIFFERENTIAL INPUT (NO INPUT JUMPERS SET) ..... 37

FIGURE 3.4: ATR19 BASE BOARD WITH INPUT JUMPER SETTINGS FOR SIGNAL INPUT THROUGH THE “+” LEMO INPUT (50Ω IMPEDANCE TO GROUND, NON-INVERTING, FOR NEGATIVE SIGNAL INPUT). THE LEVEL CONTROL BOARD WAS REMOVED HERE FOR BETTER VIEW. .... 37

FIGURE 3.5: DLATR AMPLIFIER AND CONSTANT FRACTION DISCRIMINATOR BOARDS. .... 38

FIGURE 3.6: DLATR+ VERSION (LEFT) AND DLATR2.0 (RIGHT) ..... 38

FIGURE 3.7: INPUTS, OUTPUTS AND CONTROLS OF THE ATR19 FOR EACH INTERNAL DLATR BOARD ..... 39

FIGURE 3.8: REAR PANEL OF THE ATR19 (FOR ATR19-2 SEE CHAPTER 3.6) ..... 41

FIGURE 3.9: ATR19-2B MODULE ..... 42

FIGURE 3.10: FRONT AND REAR PANEL OF THE ATR19-2 (LEFT) AND ATR19-2B (RIGHT) ..... 43

FIGURE 3.11: TYPICAL AMPLIFIED PULSE SHAPE OF THE MCP AS OBTAINED FROM THE ATR19 ANALOGUE MONITOR OUTPUT. .... 43

FIGURE 3.12: TYPICAL (ANALOGUE) OSCILLOSCOPE SCREEN OUTPUT SHOWING DELAY-LINE SIGNALS FROM A DLATR+ BOARD: ANALOGUE SIGNALS (MONITOR OUTPUT) ON UPPER TRACE AND THE CORRELATED CFD OUTPUTS (NIM) ON THE LOWER TRACE. BOTH TRACES ARE TRIGGERED BY THE NIM SIGNAL. THE PULSE HEIGHT DISTRIBUTION OF THE ANALOGUE SIGNALS CAN BE SEEN AND ALSO THE EFFECT OF THE THRESHOLD SETTING ON THE REGISTERED EVENTS (CUT-OFF OF SMALLER SIGNALS NOT BEING REGISTERED). .... 44

FIGURE 3.13: SIGNAL TRACES AS IN FIGURE 3.12, BUT WITH LOW THRESHOLD SETTING VERY CLOSE TO THE NOISE LEVEL (LEFT). PRE-TRIGGERED SIGNALS ARE PRESENT. THE RIGHT PICTURE SHOWS THE CFD OUTPUT OF AN ERRONEOUS PRE-TRIGGERED EVENT. .... 44

FIGURE 3.14: OVERVIEW OF ATR19 SIGNAL OUTPUTS FOR LOW THRESHOLD SETTINGS, TRIGGERED ON THE CFD SIGNAL. 45

FIGURE 3.15: TIME SUM SPECTRA FROM A DELAY-LINE ANODE FOR DIFFERENT THRESHOLD SETTING. LEFT: CLEAN SPECTRUM, RIGHT: CONTRIBUTION OF NOISE AND PRE-TRIGGER SIGNALS CAN BE SEEN. SETTING A SOFTWARE GATE ON THE TIME SUM PEAK MAY STILL PRODUCE RESULTS WITH A DECENT IMAGING PERFORMANCE. .... 45

FIGURE 3.16: CONNECTORS ON THE BACK OF THE SPS1 ..... 46

FIGURE 3.17: HOW TO REMOVE THE INPUT FUSE ..... 48

FIGURE 3.18: FUSE HOLDER ..... 48

FIGURE 3.19: ADJUSTING THE OUTPUT VOLTAGES (SPS1 SEEN FROM BOTTOM SIDE) ..... 48

FIGURE 3.20: OPENING THE FUSE HOLDER ..... 49

FIGURE 3.21: REMOVE THE RIBBON CABLE FROM THE POWER SUPPLY ..... 50

FIGURE 3.22: OUTPUT FUSES ..... 50

FIGURE 3.23: VOLTAGES NEAR THE OUTPUT FUSES ..... 51

FIGURE 3.24: LEDs AT THE FRONT PANEL ..... 51

FIGURE 4.1: HPTDC8 PCI CARD ..... 53

FIGURE 4.2: PCI2PCIe ADAPTER CRATE WITH PCIe CARD FOR THE PC. HERE TWO TDC8HP AND A CLOCK CARD ARE INSERTED ..... 54

FIGURE 4.3: HM1-B/T AND HM1-B FRONT PANEL ..... 55

FIGURE 4.4: PCI INTERFACE CARD ..... 55

FIGURE 4.5: TDC8PCI2 BOARD ..... 55

FIGURE 4.6: SIDE AND INPUT PANEL VIEW OF THE HM1 - I/O-BOARD (PCI) ..... 56

FIGURE 4.7: SIDE AND INPUT PANEL VIEW OF THE HM1 - I/O-BOARD (ISA) ..... 57

FIGURE 4.8: SCREEN AFTER STARTING THE COBOLDPC 2011 R3 PROGRAM ..... 59

FIGURE 5.1: 2x4kV POWER SUPPLY (FRONT PANEL) ..... 69

FIGURE 5.2: 2x4kV POWER SUPPLY (SIDE-PANEL) ..... 70

FIGURE 5.3: 2x4kV POWER SUPPLY (REAR-PANEL) ..... 70

FIGURE 5.4: BIASET3 WITH SPS2 AND ONE HV2/4 MODULE (CORRESPONDS TO BIASET3-2) ..... 71

FIGURE 5.5: SPS2 FRONT AND REAR PANEL WITH CONNECTION CABLE TO HV2/4 MODULE (NOT SHOWN) ..... 72

FIGURE 5.6: SPS2MINI MAINS ADAPTER (LEFT) AND THE SPECIFIC LABEL (RED ARROW) ON THE FRONT SIDE OF A “N24”- TYPE HV2/4 MODULE WHICH CAN BE POWERED BY IT. THE N24-TYPE HV MODULES CAN ALSO BE OPERATED WITH OLD-TYPE NIM-CRATES THAT DOES NOT SUPPLY THE  $\pm 6V$ ..... 72

FIGURE 5.7: **ROENTDEK** BA3 BATTERY BOX. THE VOLTAGE INPUT IS ON THE LEFT SIDE, THE OUTPUT CONNECTORS (HERE AS RESERVE SHV) ON THE RIGHT SIDE. THE INPUT VOLTAGE IS ROUTED TO THE UPPER VOLTAGE OUTPUT (FOR  $U_{REF}$ ) AND PRODUCES WITH THE INTERNAL BATTERY PACK THE SIGNAL VOLTAGE  $U_{SIG} = U_{REF} + 36V$  (NOMINALLY) ON THE LOWER OUTPUT CONNECTOR. .... 73

FIGURE 5.8: HIGH VOLTAGE TERMINATOR HERE WITH  $1M\Omega$  RESISTOR TO GROUND AND REVERSE SHV CONNECTOR ON ONE SIDE. .... 74

FIGURE 5.9: HVZ WITH THE SHV CONNECTOR SOCKETS..... 75

FIGURE 5.10: HVZ WITH JUMPER OPTIONS. .... 76

## List of Tables

TABLE 2.1: FT12TP PIN DESCRIPTION FOR DLD DETECTORS ..... 25

TABLE 2.2: FT12(TP) PIN DESCRIPTION FOR HEX DETECTORS ..... 26

TABLE 2.3: TYPICAL DETECTOR VOLTAGE SETTINGS (CHEVRON SETS OF 60:1 MCP). THE (DELAY-LINE ANODE) “HOLDER” POTENTIAL NEEDS TO BE CAREFULLY ADJUSTED LATER TO ACHIEVE OPTIMAL LINEAR IMAGING PERFORMANCE AT OUTER DETECTION DIAMETERS ..... 31

TABLE 3.1: PIN ASSIGNMENTS OF THE 9-PIN SUB-D OUTPUT CONNECTOR ..... 47

TABLE 3.2: USED FUSES..... 47

TABLE 3.3: TROUBLESHOOTING ..... 48

TABLE 5.1: PIN ASSIGNMENTS OF STANDARD **ROENTDEK** 9-PIN SUB-D VOLTAGE CONNECTOR. .... 70

## List of Equations

EQUATION 1.1 ..... 9

EQUATION 1.2 ..... 9

EQUATION 1.3 ..... 9

EQUATION 1.4 ..... 10

EQUATION 1.5 ..... 10

EQUATION 2.1 ..... 29

EQUATION 5.1 ..... 74