

Deep Learning and Quantum Gravity

Koji Hashimoto (Osaka U.)

“Neural ODE and Holographic QCD”

ArXiv:2006.00712 w/ H.Y.Hu, Y.Z.You (UCSD)

“Deep Learning and AdS/QCD”

ArXiv:2005.02636 w/ T. Akutagawa, T. Sumimoto (Osaka u)

“Deep Boltzmann Machine and AdS/CFT”

ArXiv:1903.04951

“Deep Learning and AdS/CFT” “Deep Learning and Holographic QCD”

ArXiv:1802.08313, 1809.10536

w/ S. Sugishita (Kentucky), A. Tanaka, A. Tomiya (RIKEN)

- > Osaka CTSR – RIKEN iTHES/iTHEMS - Kavli IPMU
- > Joint symposium

Deep Learning and physics

- > Venue: Nambu hall, Osaka university
- > Date: June 5 (Mon), 2017, 13:00-18:00
- > Invited speakers :
 - > S. Amari (RIKEN)
 - > S. Ikeda (ISM / Kavli IPMU)
 - > Y. Kawahara (Osaka U. / RIKEN)
 - > M. Taki (RIKEN)
 - > A. Tanaka (RIKEN)
 - > T. Ohtsuki (Sophia U.)
 - > N. Suzuki (Kavli IPMU) ■



- > Organizers:
 - > K. Hashimoto (Osaka U.)
 - > T. Hatsuda (RIKEN iTHES/iTHEMS)
 - > H. Murayama (Kavli IPMU) ■

Similarity!?

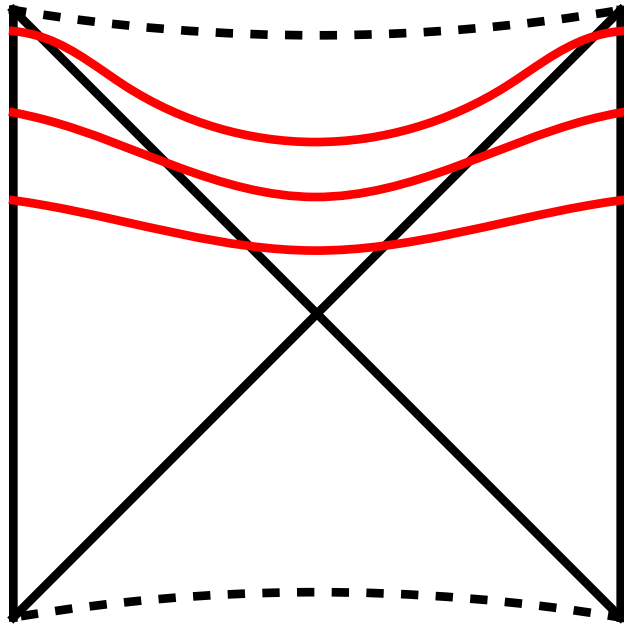

Wormholes in Penrose diagram
of maximally extended eternal
AdS Schwarzschild black hole
[Iizuka, Sugishita, KH '17]

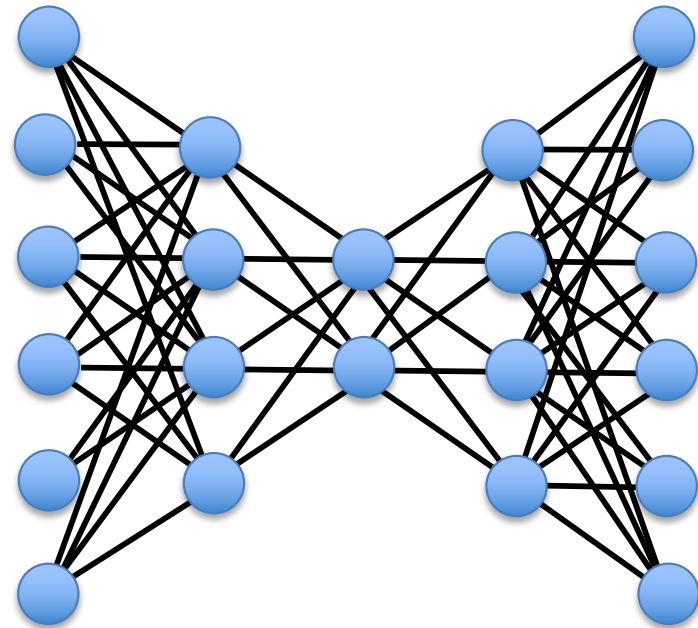

Deep Autoencoder

Roadmap

Quantum gravity
in $(d+1)$ -dim.

'tHooft '93
Susskind '94
Maldacena '97

Quantum mechanics
in d -dim.

General
spacetime



Anti de Sitter
spacetime

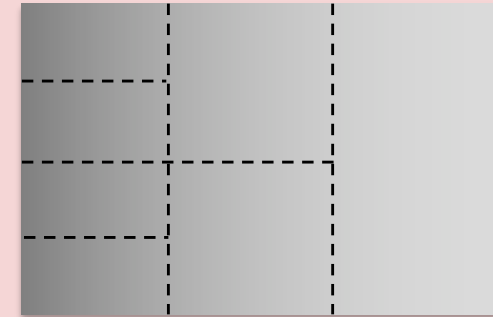

|| ?

|| Swingle '10

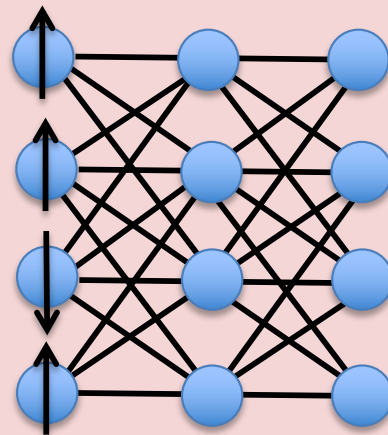

Neural network

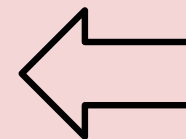

Carleo,
Troyer '17

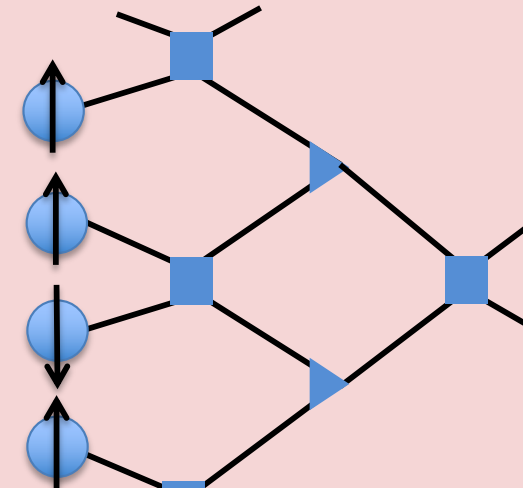

Tensor network

Roadmap

1.

Quantum gravity
in $(d+1)$ -dim.

'tHooft '93
Susskind '94
Maldacena '97

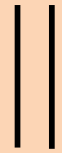

Quantum mechanics
in d -dim.

General
spacetime



Anti de Sitter
spacetime

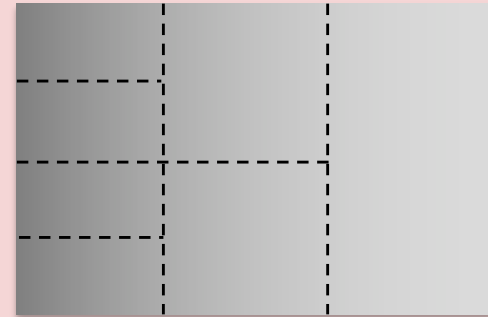

|| ?

|| Swingle '10

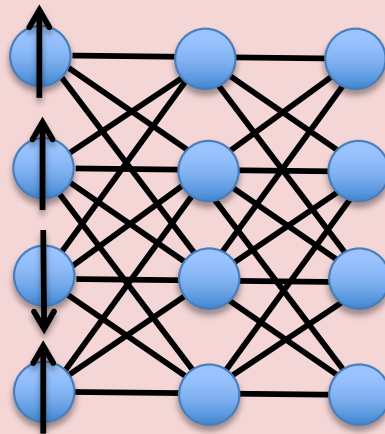

Neural network

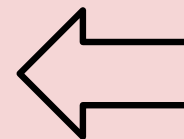

Carleo,
Troyer '17

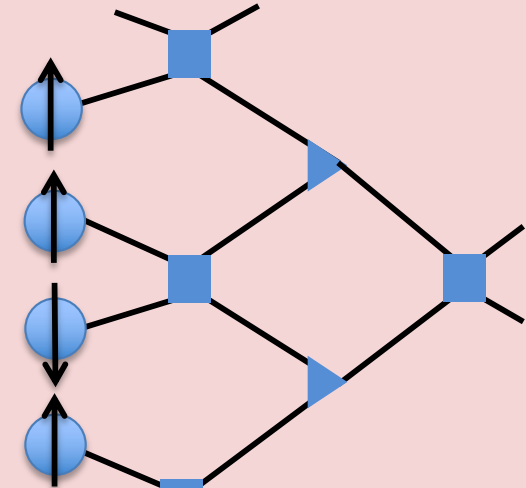

Tensor network

Roadmap

Quantum gravity
in $(d+1)$ -dim.

'tHooft '93
Susskind '94
Maldacena '97

Quantum mechanics
in d -dim.

General
spacetime



Anti de Sitter
spacetime

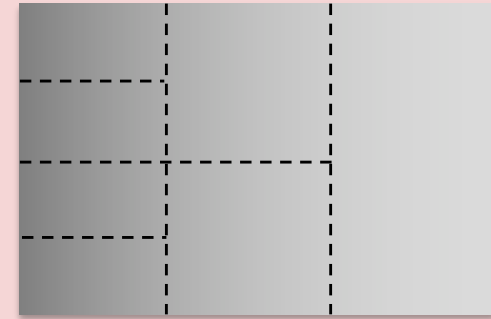

|| ?

2.

|| Swingle '10

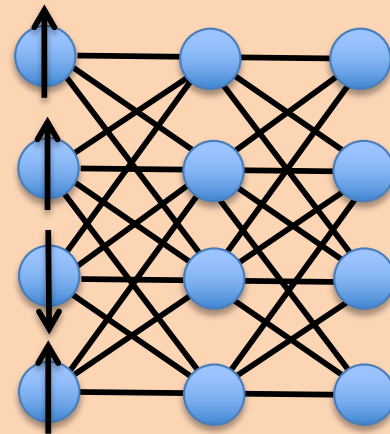

Neural network

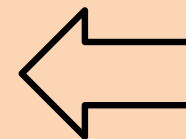

Carleo,
Troyer '17

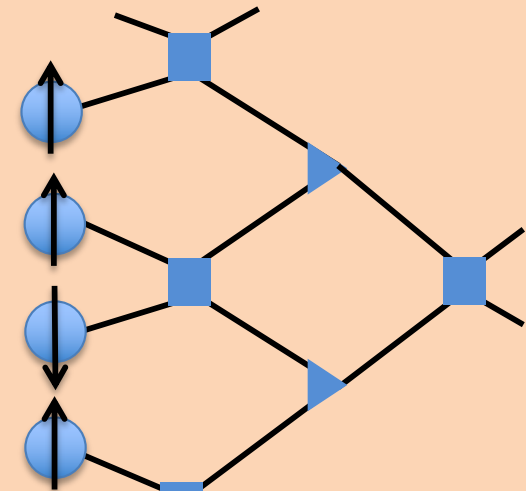

Tensor network

Roadmap

3.

General
spacetime



|| ?

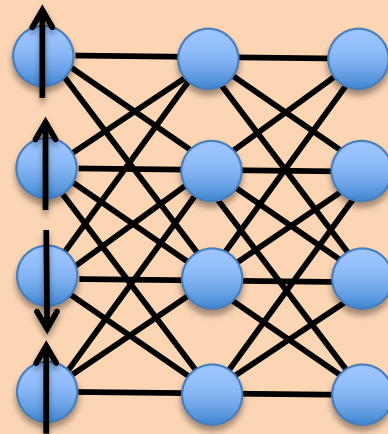

Neural network

Carleo,
Troyer '17

Anti de Sitter
spacetime

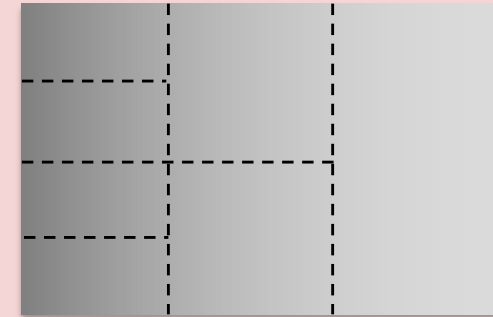

|| Swingle '10

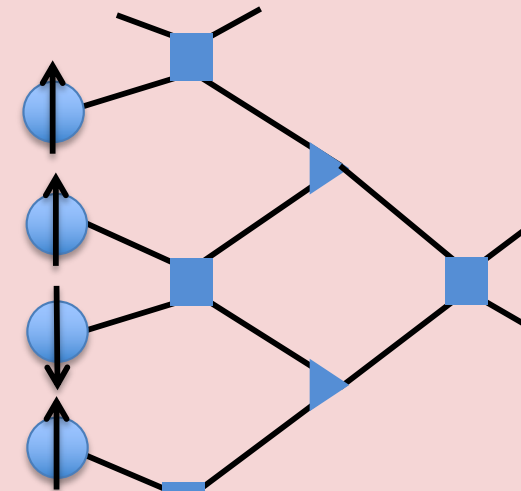

Tensor network

Quantum
gravity
in $(d+1)$ -dim.

'tHooft '93
Susskind '94
Maldacena '97

Quantum
mechanics
in d -dim.

Roadmap

4.

Quantum gravity
in $(d+1)$ -dim.

'tHooft '93
Susskind '94
Maldacena '97

Quantum mechanics
in d -dim.



General
spacetime

|| ?

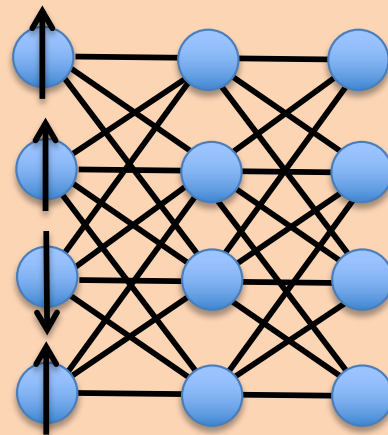

Neural network

Carleo,
Troyer '17

Anti de Sitter
spacetime

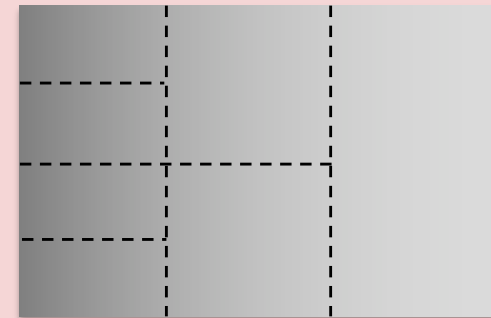

|| Swingle '10

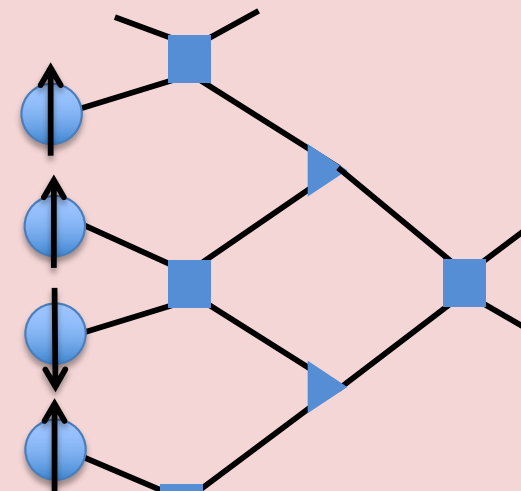

Tensor network

Deep Learning and Quantum Gravity

- ① Quantum gravity 3 pages
- ② Neural network quantum states 3 pages
- ③ When is NN a spacetime? 5 pages
- ④ Spacetime emergent from data 4 pages

Discussion: Quantum gravity \subset ML ?

① Quantum Gravity

1/3

Brief History of quantum gravity

1974 'tHooft, Veltman:
Perturbation fails in Einstein gravity.

1970 Nambu, Susskind, Nielsen:
String theory of hadrons.

1974 Yoneya, Scherk, Schwarz:
String is quantum gravity.

1971 Bekenstein:
Black hole entropy.

1993 'tHooft, Susskind:
Holographic principle.

1997 Maldacena:
AdS/CFT correspondence.

① Quantum Gravity

2/3

AdS/CFT correspondence, no proof

[Maldacena, Adv.Theor.Math.Phys. 2 (1998) 231]

“CFT”

“Large N”

Quantum mechanics
in d -dim. spacetime

=

“AdS”

Classical

~~Quantum~~ gravity
in $(d+1)$ -dim. spacetime

- No proof!
- Given Left, how can one get Right?
- Vast amount of evidence known
- Maldacena’s paper is top-of-top-cite

① Quantum Gravity

Dictionary : equating partition functions

[Gubser, Klebanov, Polyakov, Phys.Lett.B428(1998)105]

[Witten, Adv.Theor.Math.Phys. 2 (1998) 253]

Partition function of
Quantum mechanics

$$Z[\phi_0]$$

||

$$\int [\mathcal{D}q(t)] e^{-\int dt (\mathcal{L}[q, \dot{q}] + \phi_0(t) \mathcal{O}[q])}$$

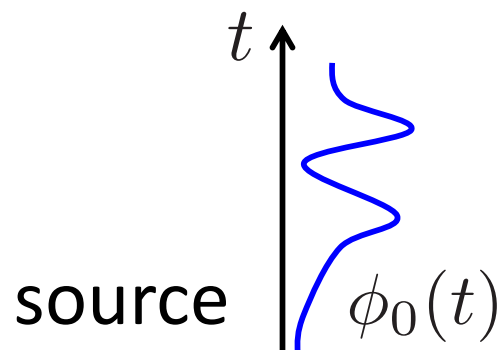

Partition function of
Classical gravity

$$Z[\phi_0]$$

||

$$e^{-\int dt dz \sqrt{-g} (R[g] + \mathcal{L}[\phi] + \dots)}$$

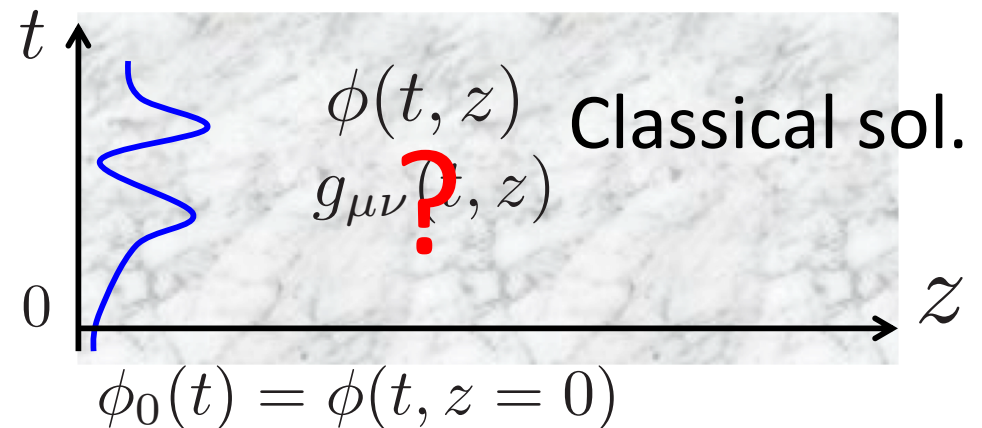

② Neural Network Quantum States 1/3

Find ground state wave function $\psi(s_1, s_2, \dots, s_N)$

Q : Minimize its energy E for a given Hamiltonian H ,

$$E = \frac{\sum_{s_1, \dots, s_N, s'_1, \dots, s'_N} \psi^\dagger(s'_1, \dots, s'_N) \hat{H}_{s'_1, \dots, s'_N, s_1, \dots, s_N} \psi(s_1, \dots, s_N)}{\sum_{s_1, \dots, s_N} \psi^\dagger(s_1, \dots, s_N) \psi(s_1, \dots, s_N)}$$

A : Use ansatz and optimize parameters!

- Matrix product states

$$\psi(s_1, s_2, \dots) = \text{tr}[A^{(s_1)} A^{(s_2)} \dots]$$

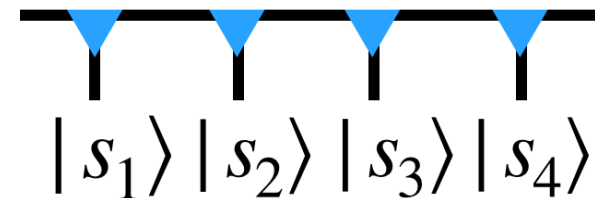

- Tensor network states

$$\psi(s_1, s_2, \dots) = \sum_{m,n} B_{mn} A_{ms_1s_2} A_{ns_3s_4}$$

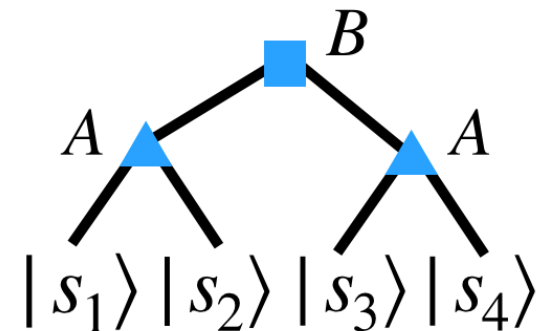

② Neural Network Quantum States ^{2/3}

Neural network can be wave functions

- Boltzmann machine states

[Carleo, Troyer `17],

[Nomura, Darmawan, Yamaji, Imada `17], ..

$$\psi(s_1, \dots, s_N) = \sum_{h_A} \exp \left[\sum_a a_a s_a + \sum_A b_A h_A + \sum_{a,A} J_{aA} s_a h_A \right]$$

- Deep Boltzmann machine states

[Carleo, Nomura, Imada `18], ..

- Feedforward network states [Saito `18], ..

$$\psi(s_1, \dots, s_N) = \sum_i f_i \sigma \left(\sum_j W_{ij} s_j + b_i \right)$$

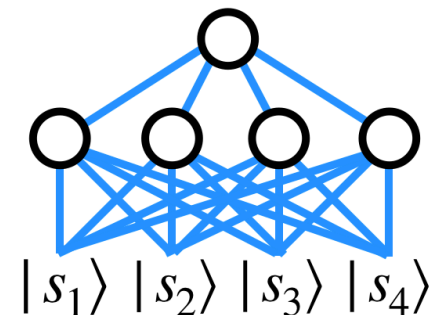
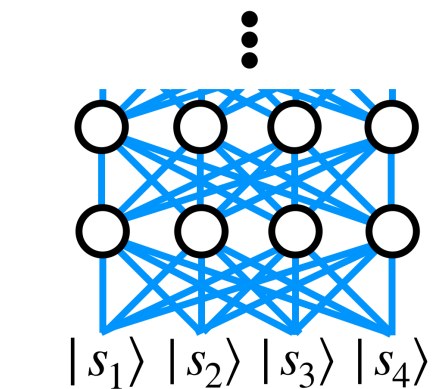
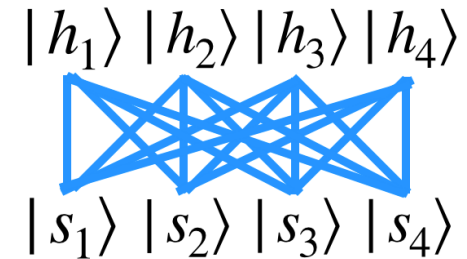

② Neural Network Quantum States 3/3

Better? and Why?

Neural states may beat conventional ones.

Ex) 2-dimensional
antiferromagnetic
Heisenberg model
[Carleo, Troyer `17]

Energy with
RBM states

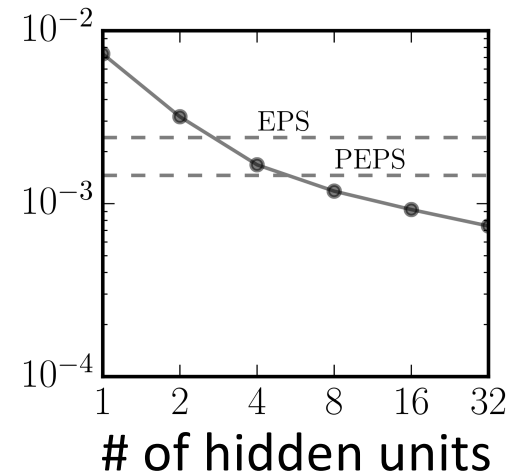

Discovered intimate relations are there.

1) Boltzmann machine states are tensor network states

[Chen, Cheng, Xie, Wang, Xiang `18]

2) Tensor states are deep Boltzmann [Gao, Duan `17] [Huang, Moore `17]

3) Tensor states are feedforward with “product pooling”

[Cohen, Shashua `18]

Ex) Unified approach: MPO-Net [Gao, Cheng, He, Xie, Zhao, Lu, Xiang `19]

3.

When is NN a spacetime?

1/5

General NN is not a space

No notion of which unit is close to which

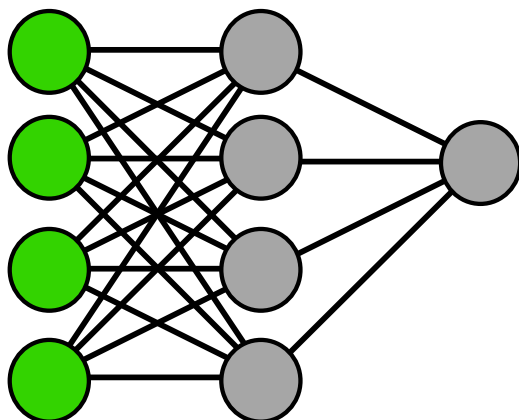

Perceptron model

[Rosenblatt 1958]

[Rumelhart, McClelland 1986]

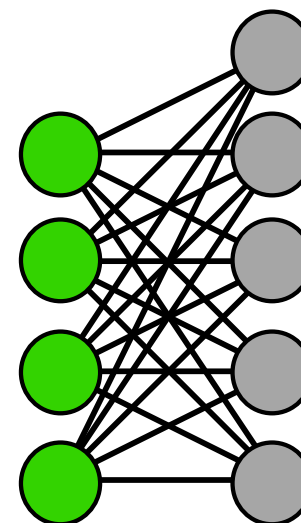

Boltzmann machine

[Ackley, Hinton, Sejnowski 1985]

3. When is NN a spacetime?

2/5

Sparsity + weight sharing, for NN to be a space

No locality

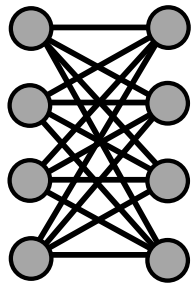

Fully
connected

Locality imposed

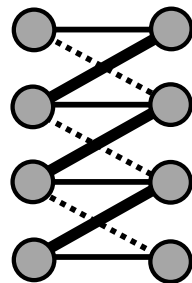

Convolutional
layer

[K. Fukushima '80]

=

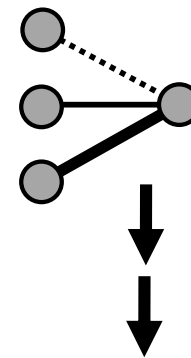

Parallelly
translated

Input: $\phi(n\Delta x)$

Output:

$$a\phi(n\Delta x) + b\partial_x\phi(n\Delta x) + c\partial_x^2\phi(n\Delta x) + \dots$$

③ When is NN a spacetime?

3/5

NN depth as time

Dynamical system

$$\dot{x}_i = f_i(x(t)) \quad \Longrightarrow \quad x_i(t_{n+1}) = \underline{x_i(t_n)} + \Delta t \cdot f_i(x(t_n))$$

$$t_{n+1} = t_n + \Delta t$$

Discretized time

ResNET (Residual network) : easily trained deep model

[K.He et al.,1512.03385]

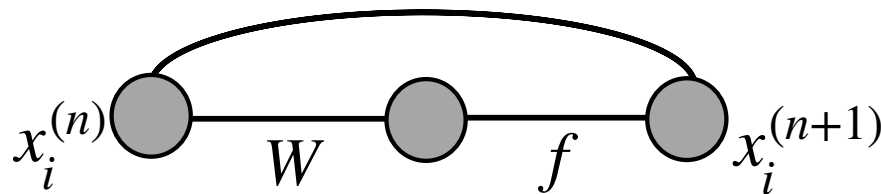

$$x_i^{(n+1)} = f(W_{ij}x_j^{(n)}) + \underline{x_i^{(n)}}$$

Skip connection

3.

When is NN a spacetime?

Hamilton dynamics is a NN

1802.08313

$$\dot{q} = \frac{\partial H}{\partial p}, \quad \dot{p} = -\frac{\partial H}{\partial q}$$

Time-dependent Hamiltonian = weights/activation

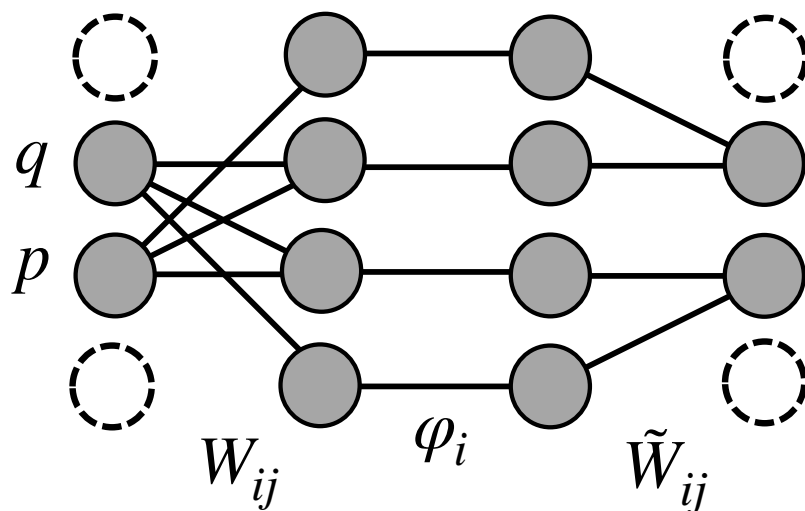

$$W = \begin{pmatrix} 0 & 0 & v & 0 \\ 0 & 1 + \Delta t w_{11} & \Delta t w_{12} & 0 \\ 0 & \Delta t w_{21} & 1 + \Delta t w_{12} & 0 \\ 0 & u & 0 & 0 \end{pmatrix}$$

$$\varphi_i = \begin{pmatrix} \Delta t f(x) \\ 1 \\ 1 \\ \Delta t g(x) \end{pmatrix} \quad \tilde{W} = \begin{pmatrix} 0 & 0 & 0 & 0 \\ \lambda_1 & 1 & 0 & 0 \\ 0 & 0 & 1 & \lambda_2 \\ 0 & 0 & 0 & 0 \end{pmatrix}$$

$$H = w_{11}pq + \frac{1}{2}w_{12}p^2 - \frac{1}{2}w_{21}q^2 + \frac{\lambda_1}{v}F(vp) - \frac{\lambda_2}{u}G(uq)$$

($F' = f, \quad G' = g$)

3. When is NN a spacetime?

5/5

Q. Find a Hamiltonian

Consider a particle motion $x(t)$ in a given potential $V(x)$ in 1 dimension, with **unknown** time-dependent friction force $h(t)\dot{x}$.

One tried many initial conditions $(x(t=0), \dot{x}(t=0))$ and collected those which stops at $t=10$.

Q. From given data of the initial conditions, find $h(t)$.

$$m\ddot{x} = h(t)\dot{x} + \frac{\partial V(x)}{\partial x}$$

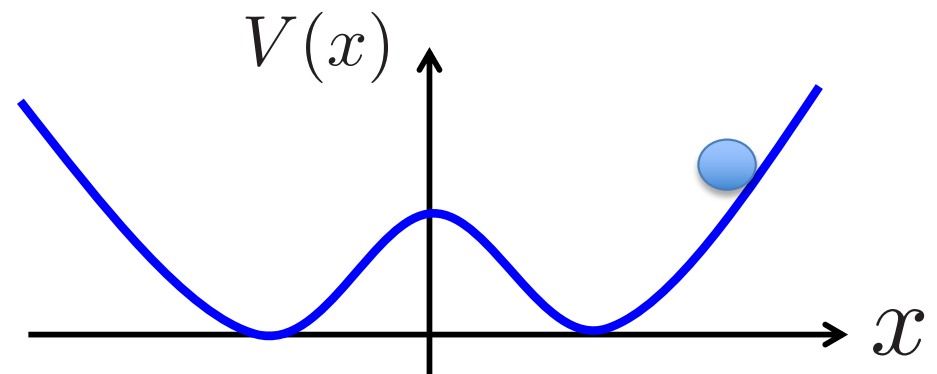

④ Spacetime emergent from data

1/4

Gravity side

Classical scalar field theory in **unknown** 5-dim. spacetime

$$S = \int d\eta d^4x \sqrt{\det g} [(\partial_\eta \phi)^2 - V(\phi)]$$

1802.08313

1809.10536

$$\begin{cases} ds^2 = -f(\eta)dt^2 + d\eta^2 + g(\eta)(dx_1^2 + \dots + dx_{d-1}^2) \\ V[\phi] = -\frac{3}{L^2}\phi^2 + \frac{\lambda}{4}\phi^4 \end{cases}$$

Data: $(\phi_0, Z[\phi_0])$

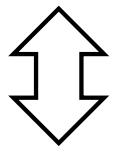

$(\phi|_{\eta=\infty}, \partial_\eta \phi|_{\eta=\infty}, \partial_\eta \phi|_{\eta=0})$

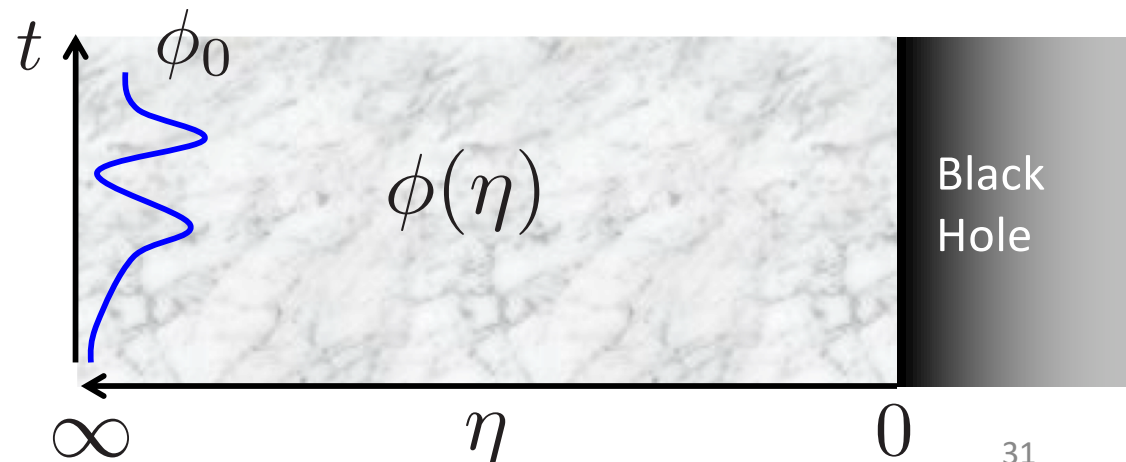

④ Spacetime emergent from data

2/4

Equation of motion as a feedforward NN

Eq. of motion $\partial_\eta^2 \phi + \underline{h(\eta)} \partial_\eta \phi - \frac{\delta V[\phi]}{\delta \phi} = 0$

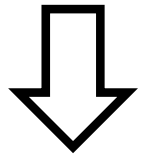

metric

$$h(\eta) \equiv \partial_\eta \left[\log \sqrt{f(\eta)g(\eta)^{d-1}} \right]$$

Discretization Hamilton form $\begin{cases} \phi(\eta + \Delta\eta) = \phi(\eta) + \Delta\eta \pi(\eta) \\ \pi(\eta + \Delta\eta) = \pi(\eta) + \Delta\eta \left(\underline{h(\eta)} \pi(\eta) - \frac{\delta V(\phi(\eta))}{\delta \phi(\eta)} \right) \end{cases}$

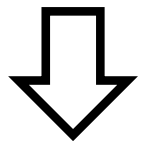

Feedforward neural network for classification

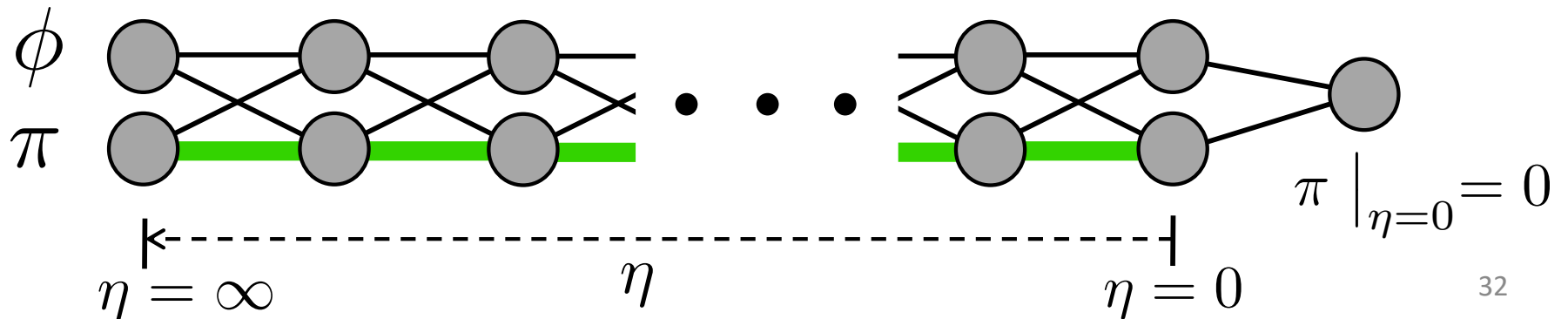

④ Spacetime emergent from data

3/4

Training with data of quark condensate

Data of quantum chromodynamics
simulated by supercomputer

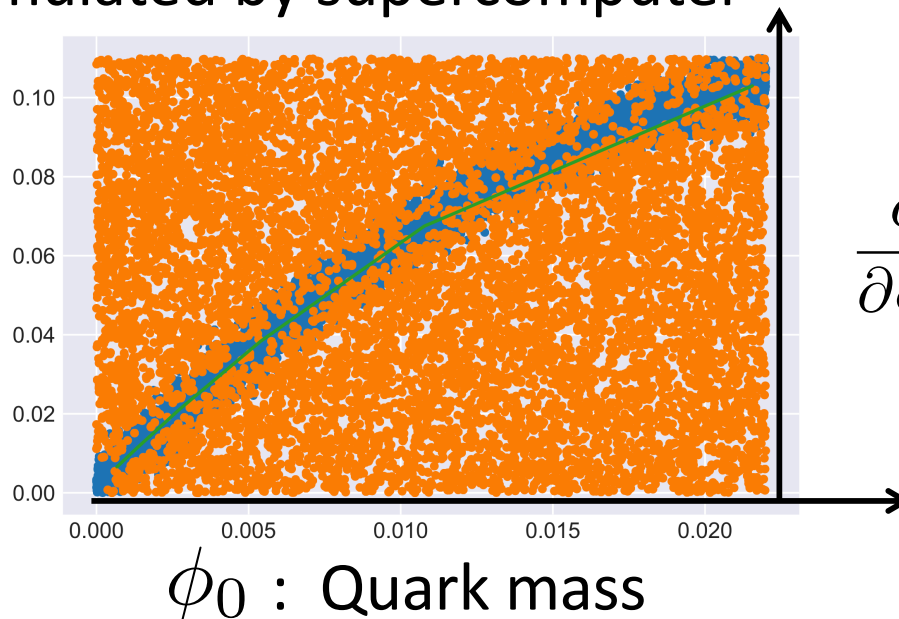

$\frac{\partial}{\partial \phi_0} Z[\phi_0]$: Quark condensate

④ Spacetime emergent from data

3/4

Training with data of quark condensate

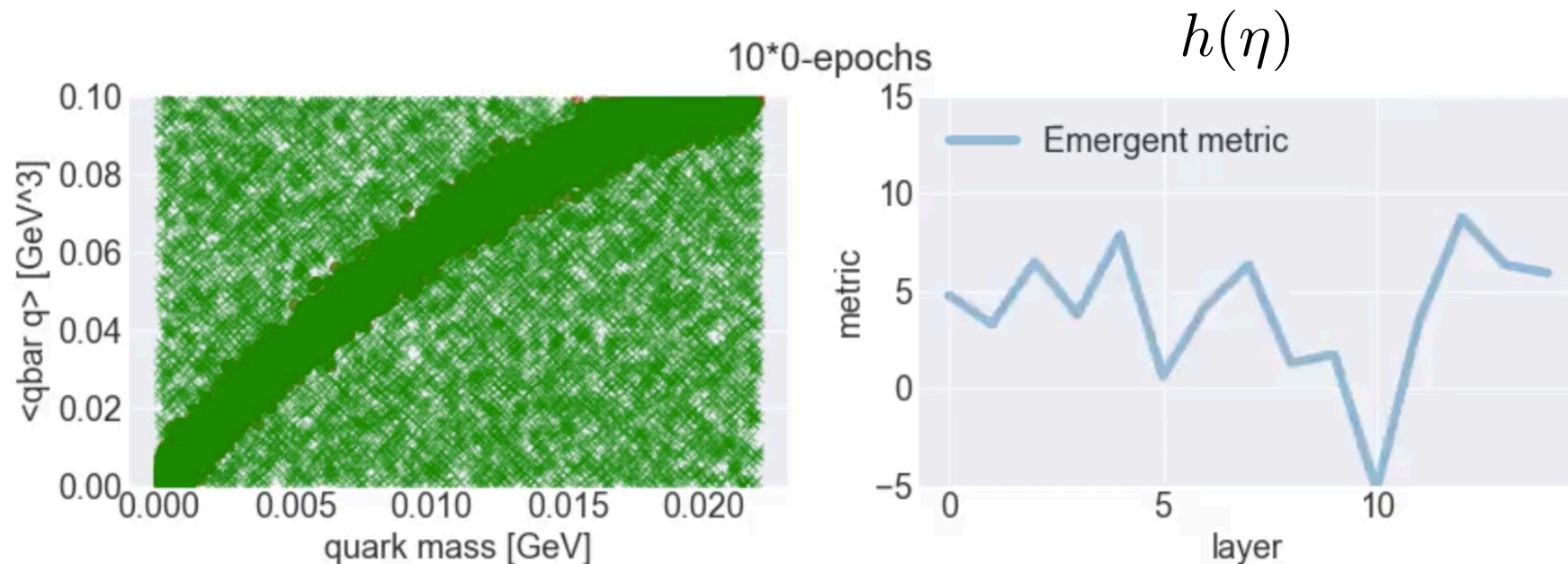

Trained values of potential :

$$1/L = 237(3)[\text{MeV}], \quad \lambda/L = 0.0127(6)$$

④ Spacetime emergent from data

4/4

Emergent metric can predict physics

Interquark potential

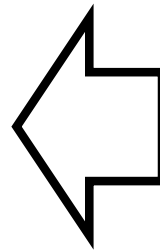
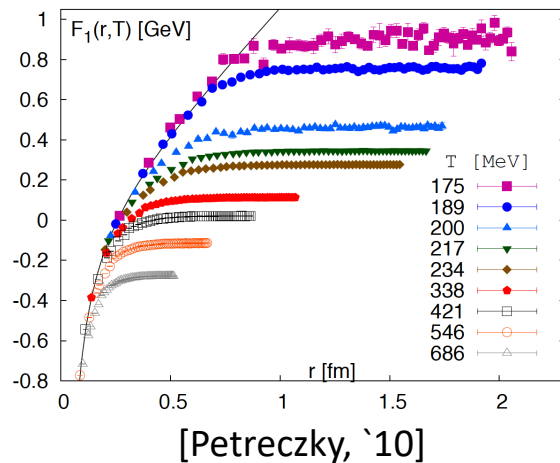
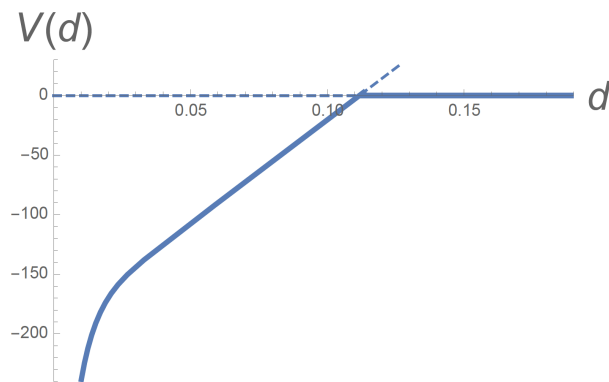

Procedures based on [Maldacena] [Rey,Theisen,Yee]

$$h(\eta)$$

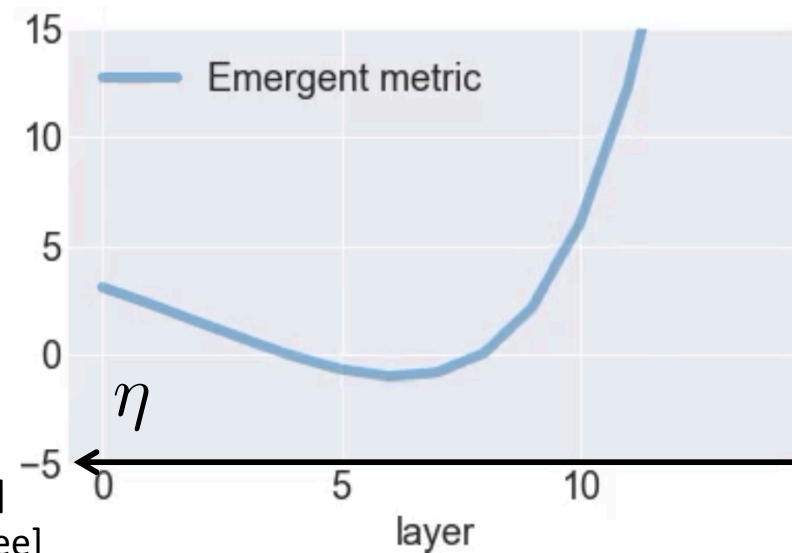

Discussion: Quantum gravity \subset ML ?

3 steps for quantum gravity

Quantum Mechanics side	Gravity side		Architecture
	metric $g_{\mu\nu}$	field ϕ	
Large DoF limit	Classical	Classical	Feedforward NN
Large DoF expansion	Classical	Quantum	Deep Boltzmann
Finite DoF	Quantum	Quantum	?

- Neural ODE : free from discretization
- Quantum AdS/CFT \subset Deep Boltzmann machine
- Conventional quantum gravity looks networks

Discussion: Quantum gravity \subset ML ?

Neural ODE : free from discretization

2006.00712

Residual Network

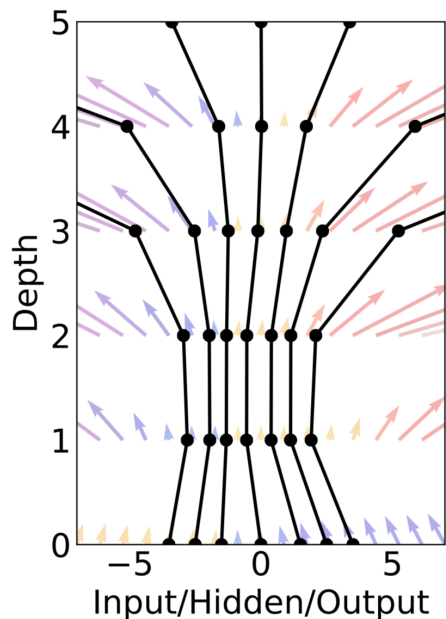

ODE Network

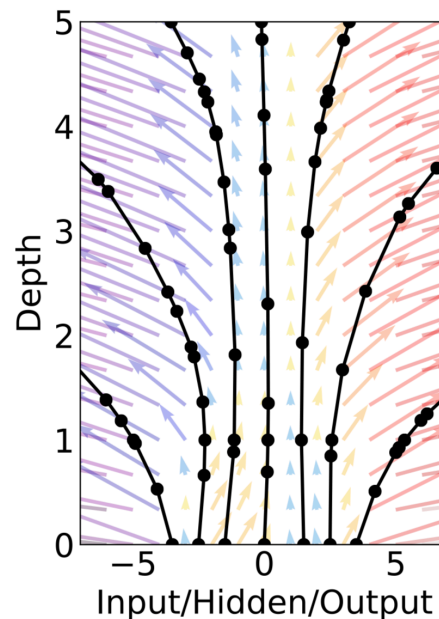

$$\frac{d\phi(\eta)}{d\eta} = f(\phi(\eta), \eta, h(\eta))$$

Emergent metric

$$h(\eta) = 8.2351\tilde{\eta}^8 + 8.0108\tilde{\eta}^7 + 7.6071\tilde{\eta}^6 + 6.9468\tilde{\eta}^5 + 150.8853\tilde{\eta}^4 - 130.8117\tilde{\eta}^3 + 55.5384\tilde{\eta}^2 - 2.22235\tilde{\eta}^1 + 3.7719.$$

$$\tilde{\eta} = 1 - \eta$$

Q Qbar potential

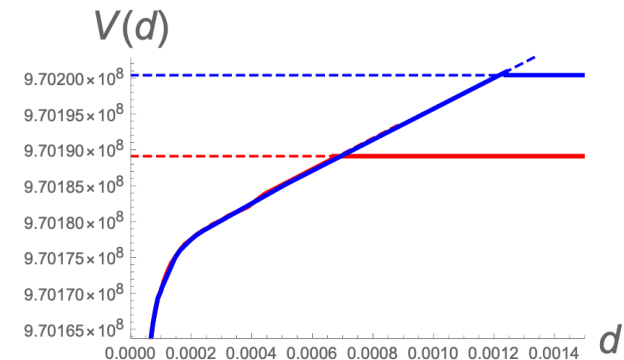

Neural ODE [R.T.Q.Chen, Y.Rubanov,
J.Bettencourt, D.Duvenaud 1806.07366]

Discussion: Quantum gravity \subset ML ?

Quantum AdS/CFT \subset Deep Boltzmann

AdS/CFT

[Maldacena 1997]

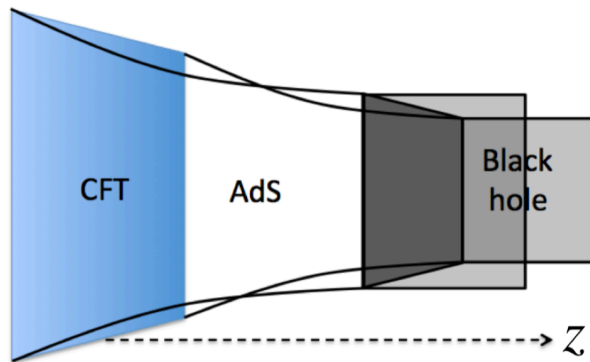

$$Z_{\text{QFT}}[J] = \int_{\phi(z=0)=J} \mathcal{D}\phi \exp(-S_{\text{gravity}}[\phi])$$

Deep Boltzmann machine

[Salakhutdinov, Hinton 2009]

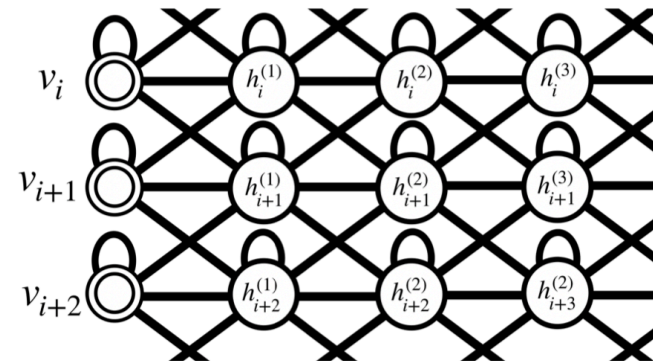

$$P(v_i) = \sum_{h_i \in \{0,1\}} \exp[-\mathcal{E}(v_i, h_i)]$$

[KH `19] [You,Yang,Qi `18] (See also [Gan,Shu `17][Howard `18])

Discussion: Quantum gravity \subset ML ?

Physical picture of Deep Boltzmann

Ground state wave function for given Hamiltonian is identified as a deep Boltzmann machine

[Carleo, Nomura, Imada '18], ..

$$|\psi\rangle = \lim_{\tau \rightarrow \infty} e^{-\tau H} |\text{any}\rangle = e^{-\Delta\tau H} e^{-\Delta\tau H} \dots |\text{any}\rangle$$

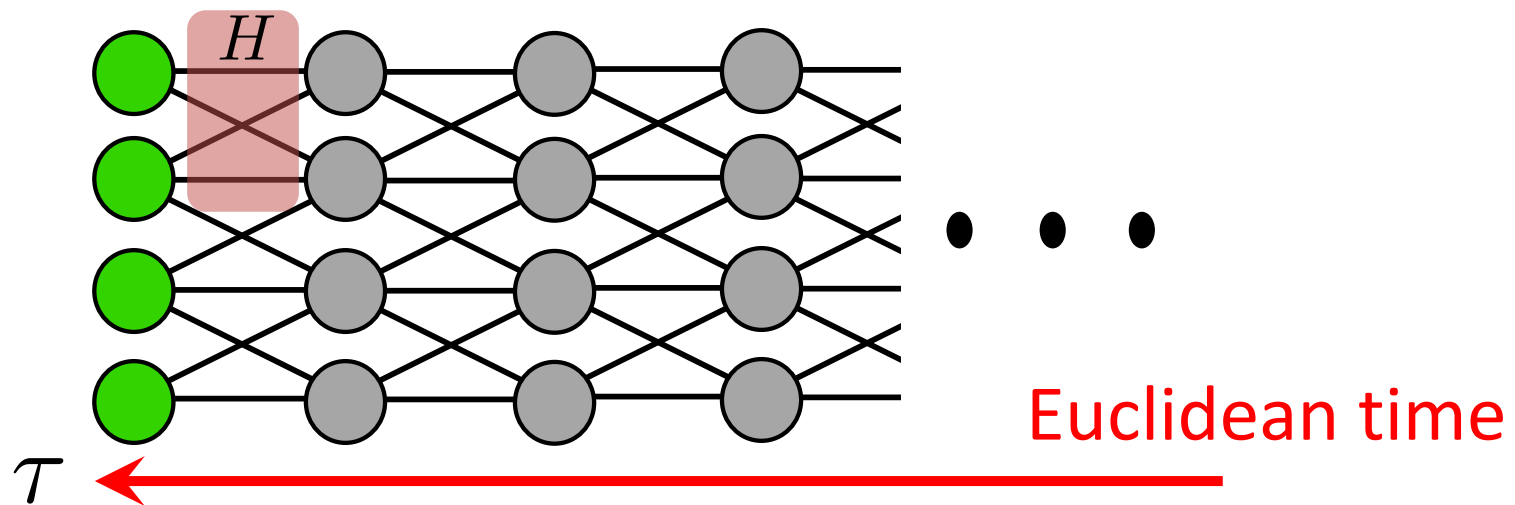

$$\psi(x_i) = \sum_{h_j^{(n)} \in \{0,1\}} \exp \left[- \sum_{ij} w_{ij}^{(0)} x_i h_j - \sum_n \sum_{ij} w_{ij}^{(n)} h_i^{(n)} h_j^{(n+1)} \right]$$

Discussion: Quantum gravity \subset ML ?

AdS/CFT discretized the bulk, but fixed

AdS/MERA

[Swingle '09]

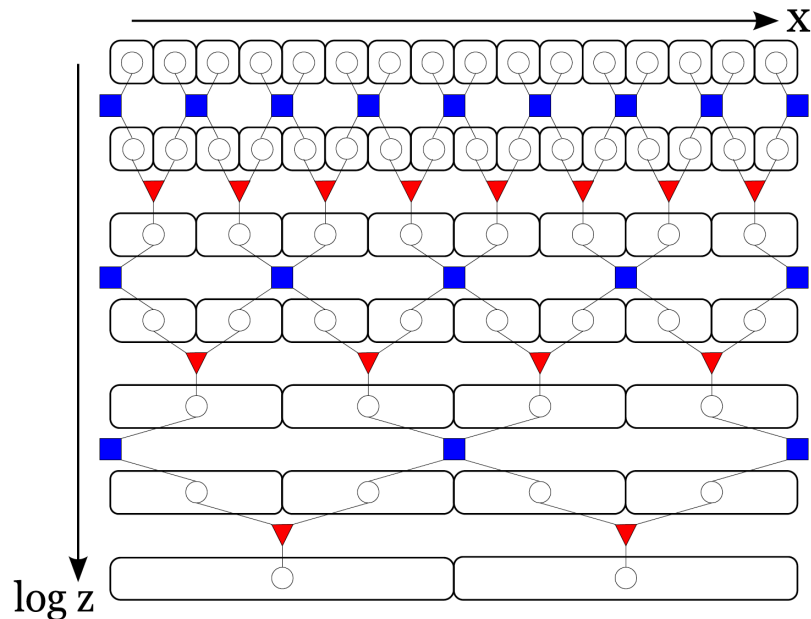

Quantum codes for holography

[Pastawski, Yoshida, Harlow, Preskill '15]

