

CEBAF System and Beamline Readiness

Arne Freyberger

Operations Dept.
Accelerator Division

JLAB

2014-08-26

Accelerator Operations Department

Talk Outline

- 1 CEBAF Elements/Beamlines not yet Commissioned
 - Not Yet Commissioned Beamlines
 - Not Yet Commissioned Elements
- 2 CEBAF activities during the 2014 Summer Down
- 3 Status of Hot Check Out (HCO)
- 4 Summary

Not Yet Commissioned Beamlines

Fall2014 Hall-D photon beamline (Session A4)

Fall2014 2T line, first pass transport line, feeds end-stations A, B or C.

Fall2014 4T line, second pass transport line, feeds end-stations A, B or C.

Fall2014 8T line, fourth pass transport line, feeds end-stations A, B or C.

Fall2014 2C line, Hall-B transport line (Session A3)

Fall2014 4C line, BSY Dump line

Spring2015 AT line, fifth pass transport line, feeds end-stations A, B or C.

Spring2016? 3C line, Hall-C transport line

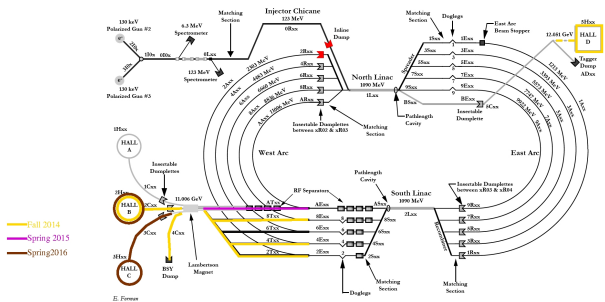

Not Yet Commissioned Elements

Fall2014 New 5MeV dipole (Injector)

Fall2014 1-4pass RF separators

Fall2014 Modified Dog-leg magnets

Fall2014 Hall-A dump line, after Summer 2014 preventative maintenance work.

Fall2014 Hall-D Active Collimator, nA BPMs

Spring2014 5-pass separators, 750MHz structures combined with 250MHz lasers in the injector.

Spring2014 Hall-D photon beam position lock.

Fall2015 Tunnel Air conditioning, to be installed Summer 2015.

Talk Outline

- 1 CEBAF Elements/Beamlines not yet Commissioned
- 2 CEBAF activities during the 2014 Summer Down
 - Magnet Power Supplies
 - New 5MeV dipole
 - 1-4 pass RF Separators
 - Modified Dog-leg magnets
 - Hall-A High Power Dump Maintenance
 - Hall-D Active Collimator and nA BPM
 - CHL-1 Maintenance
 - Utilities Infrastructure Modernization
- 3 Status of Hot Check Out (HCO)
- 4 Summary

Magnet Power Supplies

- Completed acceptance and check out of all CEBAF power supplies that did not participate in Spring2014 beam operations.
- Completed connecting all CEBAF power supplies to magnets that did not participate in Spring2014 beam operations.
- Finish synchrotron radiation compensation coil system in the upper arcs.

Sampling of completed ATLI tasks:

	11:12
Complete PM Checks on Hall B and C Power Supplies and Magnet String Connections	08/22/14 07:46
XSEP10 Box Supply Machine Integration	06/25/14 10:51
LAM3C Box Supply Machine Integration	06/11/14 16:39
COMPLETE PM CHECKS ON XSEP2T AND XSEP4T AND MAGNET INTERGRATION.	06/12/14 19:57
	06/25/14

New 5MeV Dipole and spectrometer

- Required in support of an approved experiment utilizing 10MeV electrons.
- New dipole and spectrometer will provide more precise beam momentum measurements.
 - ▶ Old 5MeV dipole systematic error, $\approx 0.4\%$.
 - ▶ New 5MeV dipole systematic error, $\approx 0.03\%$.
- Dipole installation this week.

New 5MeV Dipole:

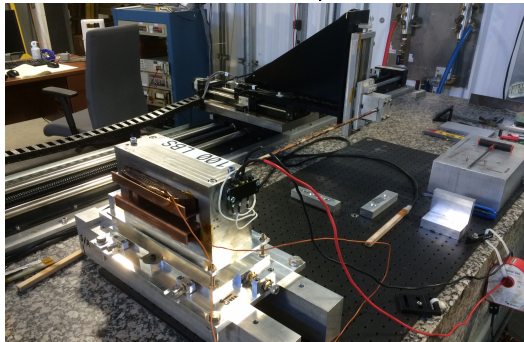

New 5MeV Spectrometer:

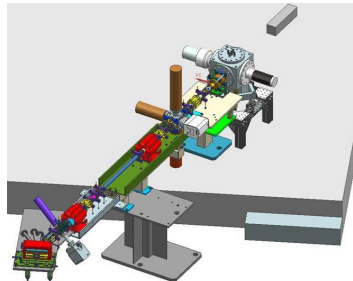

1-4 pass RF Separators

- pass 1-4 cavities installed, under vacuum.
- Complete the upgrade of the RF power (solid state amplifiers) & controls for 12GeV era beam energies.
- Tunnel and Service building installation complete.
- Non-beam testing in progress.
- Non-beam commissioning plan consistent with the 2014Fall beam schedule.

RF separator solid state amplifiers and mixer:

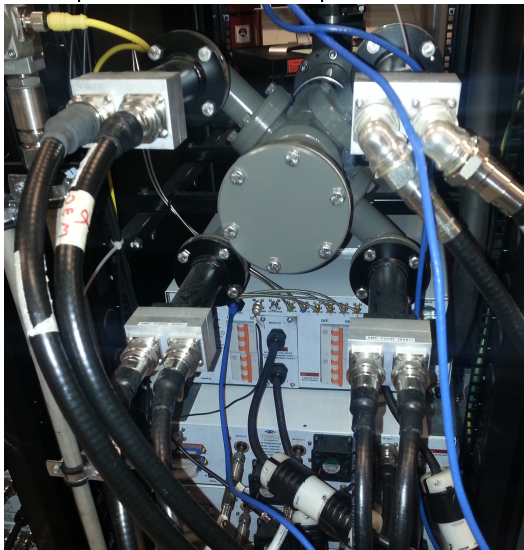

Modified Dog-leg magnets

- Upgrade magnets (add steel and new coil packs) Summer 2014. Complete.
- New cable between power supply and magnet. Complete.
- Vacuum and cable connections restoration underway
- Upgrade power supplies early 2015.

Dogleg magnet removal/insertion:



Goal of the Dog-leg upgrade project is to Restore pathlength adjustment range to near 6GeV range.

Hall-A High Power Dump Maintenance

- Detail inspection of 1MW dump, found no issues.
 - ▶ Dump entrance window thickness measured in-situ, no degradation.
 - ▶ No modifications to the 1MW dump needed.
- Improve beam transport hardware between the experimental target and the dump face.
 - ▶ Improve dump and beam diagnostics and the tunnel environment.
 - ▶ Inert the tunnel atmosphere to reduce chemical reactions.
- Project completion consistent with the Fall2014 beam schedule.

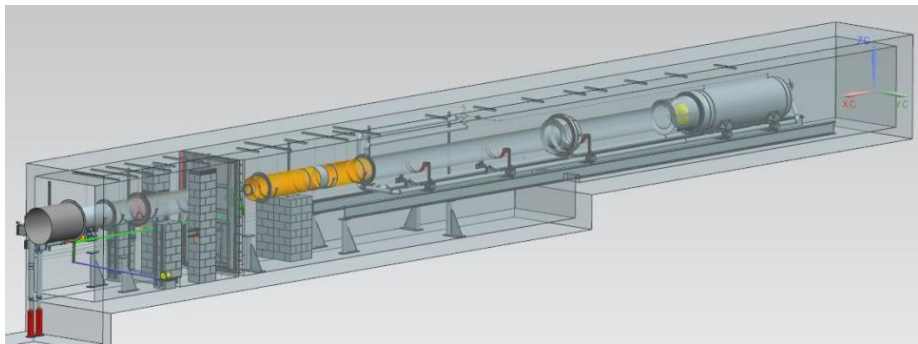

Hall-D nA Active Collimator and nA BPM

Active Collimator

- Hall-D/GlueX responsible for beamline device (see picture).
- Engineering division responsible for readout electronics and feedback system.
- Readout electronics schedule consistent for the Fall2014 beam schedule.
- Feedback will be commissioned in the Spring2015 run.

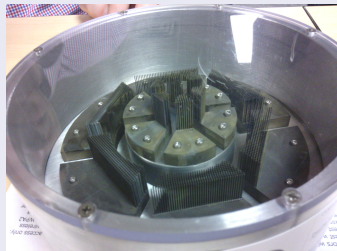

nA BPM

- Cavity style beam position monitors, with capability to measure beam position with beam current as low as $\mathcal{O}(1\text{nA})$
- Fabrication and installation is *just in time* for the start of the run.



CHL-1 Maintenance

- With CHL-2 plant maintaining both linacs at 4K, perform warm maintenance on CHL-1.
- Long overdue maintenance of cold-box, transfer lines and heat exchangers.
- CHL-1 major cause of downtime during Spring2014 operations.
- Summer2014, exchange the old Carbon bed for new clean Carbon.
- CHL-1 maintenance will resume in Summer2015.
- Summer2014 scope completion consistent with the Fall2014 beam schedule.



Utilities Infrastructure Modernization (UIM)

- Electrical Distribution: Upgrade the entire site, increase in capacity to support 12GeV loads.
 - ▶ UIM work impact on CEBAF:
 - 2014 North Linac, East Arc, South Linac and West Arc service buildings without power for several weeks.
 - 2015 Brief, localized interruptions to power (< 48h), plan supports 2K operations in Summer2015 via constant CHL2 operations.
- Cooling Tower Upgrade: Add supplemental cooling towers for increased capacity and redundancy.
 - ▶ UIM work impact on CEBAF:
 - 2014 North/South LCW unavailable for a few weeks.
 - 2015 None.
- CTF Upgrade
- Computer Center Cooling & Power Upgrade
- Communications Upgrade

Talk Outline

- 1 CEBAF Elements/Beamlines not yet Commissioned
- 2 CEBAF activities during the 2014 Summer Down
- 3 Status of Hot Check Out (HCO)
 - HCO and Operations
 - HCO Downgrades
 - HCO: Restoring the green dot
- 4 Summary

HCO and Operations

- The HCO process and tool are part of CEBAF Operations.
- HCO is the process that will continue to be used to bridge shutdown activities and beam operations.
- Extent of the HCO effort is determined by the extent of hardware worked on during the shutdown.
 - ▶ All masked items, unmasked.
 - ▶ Some elements downgraded based on the duration of the down.
 - ▶ ATLI work plans reviewed and element downgraded based on work performed.
 - ▶ Staff are encourage to downgrade items as they are worked.

HCO Downgrades:

- Some elements downgraded immediately after the run. Downgraded by staff as elements were worked.
- Systems downgraded due to the duration of the down occurred in late July.
 - ▶ all input/output controllers (IOCs) and CAMAC crates.
 - ▶ all LCW valves
 - ▶ all Vacuum valves and pumps
 - ▶ all BPMs, BLMs, BCMs, FSD nodes, Viewers,
- Review of ATLis and subsequent element downgrades occurred in late July.

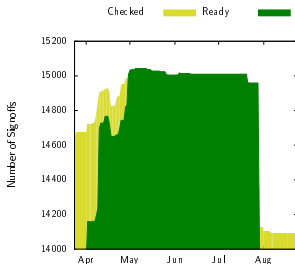

HCO Status

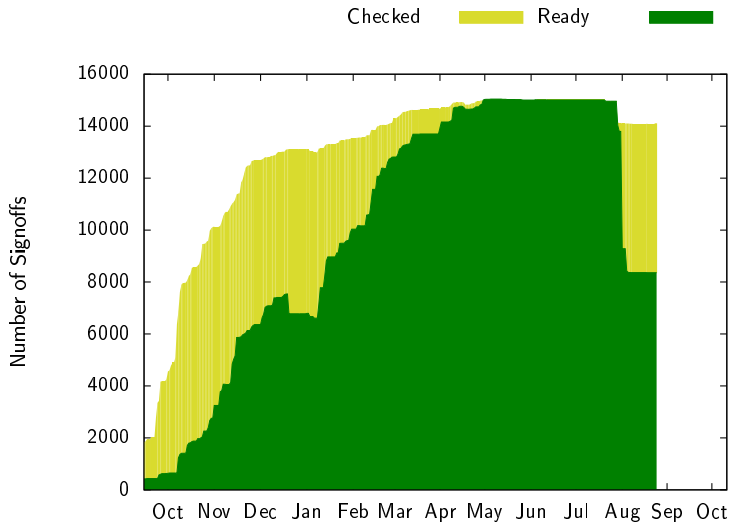

HCO and Fall Beam Operations

- Many systems on-hold waiting for power restoration (UIM) and resumption of 2K cryogens (CHL-1).
- Many checklists have been changed to reflect that elements were **ready** in the recent past.
 - ▶ Most updated checklists are more straightforward.
 - ▶ Some allow for the check to be performed in the control room.
 - ▶ Some checklists are being automated.
- August and September will be busy with HCO activities

Summary

- CEBAF delivered 5.5pass beam to the Hall-D Tagger dump and demonstrated 12GeV RF performance in Spring 2014
- CEBAF peak HCO Green state occurred in 2014-May, in support of the 5.5pass Hall-D Tagger operations.
- Work scope during Summer2014 smaller than during the 12GeV upgrade period.
- HCO tool and process have been active for over one year.
 - ▶ The thorough check-out and verification that define the HCO process has resulted in a very efficient use of beam operations.
 - ▶ HCO tool will be used to verify system readiness to support beam operations in the Fall2014 and all future CEBAF beam restorations.
- Fall operations requires:
 - ▶ Completion of HCO.
 - ▶ Completion of the CHL-1 maintenance and return to 2K operations (scheduled for Sept. 3).
 - ▶ Completion of the Summer2014 UIM work (scheduled for Aug. 29).