

HPS experiment: current sensitive preamplifiers's modifications to fit to 2 APD sizes: $5\times 5\text{ mm}^2$ or $10\times 10\text{mm}^2$

1/ Introduction and physics data

The HPS calorimeter will consist of 442 PbWO₄ crystals in truncated pyramidal shape. The size of each crystal is:

- Length = 160mm
- Area at the front side (close to target) = 13mm×13mm
- Area at the back side (close to APD) = 16mm×16mm

The energy of gammas or electrons in a crystal ranges from 10MeV up to 3 GeV. The 2 Hamamatsu APDs that we can use are: S8664-55 and S8664-1010.

The preamplifiers from the previous IC calorimeter (years 2004-2005) that we can modify for the tests are: N055, N076, N129 (out of order), N147, N318, N340, N346, N356, N363, N383, N402, 460, 465 and 466.

The preamplifiers from the new FT CLAS12 calorimeter that we can modify for the tests are: FT22, FT61, FT299, FT317, FT328 (Noisy, out of order), FT347 and FT396.

The APD is glued at the back area (16mm×16mm) of the crystal. The number of photo-electrons recovered by the APD is dependent of the APD size, the quality of the wrapping, the quality of the gluing, the quantum efficiency. The photo-electrons are directly generated by the photosensitive cell. Then these photo-electrons are multiplied by the APD gain. After multiplication, we call them "electrons".

We will try to estimate the theoretical value for both APDs:

About the $5\times 5\text{ mm}^2$ APDs we obtain:

- 120 photons/MeV in the PbWO₄ crystal
- The quantum efficiency is close to 75% for a wavelength of 420nm
- The area rate is 10.24 (=16×16/(5×5))

Then the **theoretical value** due to the coupling between the crystal and the $5\times 5\text{ mm}^2$ APD is :

8.8 photo-electrons/MeV (= 120×0.75/10.24)

In the following document, we will use a **more pessimistic value = 6 photo-electrons/MeV**.

About the $10\times 10\text{ mm}^2$ APDs we obtain:

- 120 photons/MeV in the PbWO₄ crystal
- The quantum efficiency is close to 75% for a wavelength of 420nm
- The area rate is 2.56 (=16×16/(10×10))

Then the **theoretical value** due to the coupling between the crystal and the $10\times 10\text{ mm}^2$ APD is :

35 photo-electrons/MeV (= 120×0.75/2.56)

In the following document, we will use a **more pessimistic value = 25 photo-electrons/MeV**.

The tests are performed with a 4.7pF injection capacitance. The falling edge (90%-10%) of the pulse generator is 20ns which gives an input current pulse width of about 20ns. For some results, the APD capacitance is emulated by an equivalent input capacitance connected to the ground.

2/ Original scheme and layout used for the IC calorimeter (DVCS experiment)

The figure 1 gives the layout (top and bottom) of the original preamplifier (DVCS IC Calorimeter).

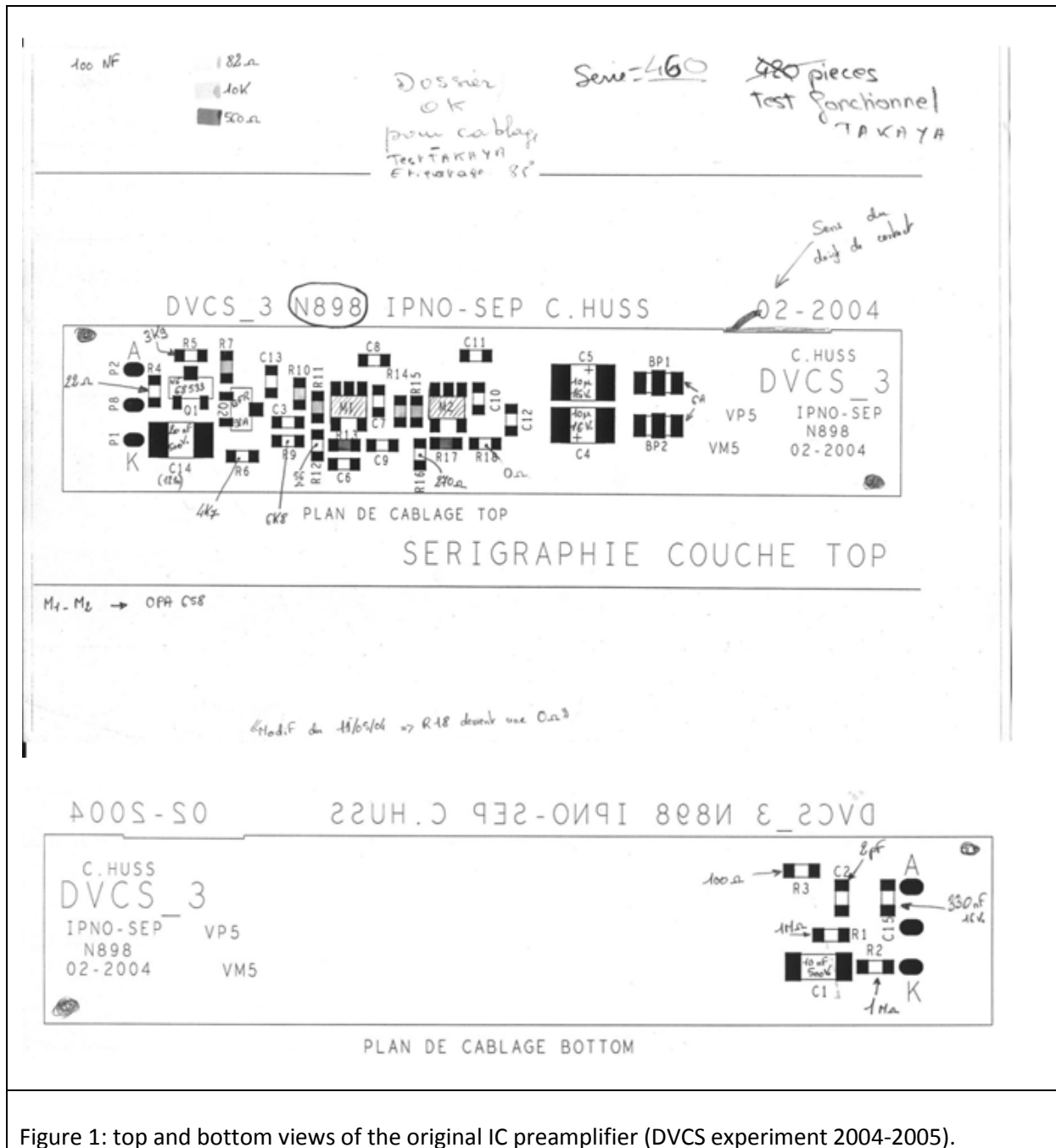

Figure 1: top and bottom views of the original IC preamplifier (DVCS experiment 2004-2005).

The figure 2 gives the original scheme.

12A 3180

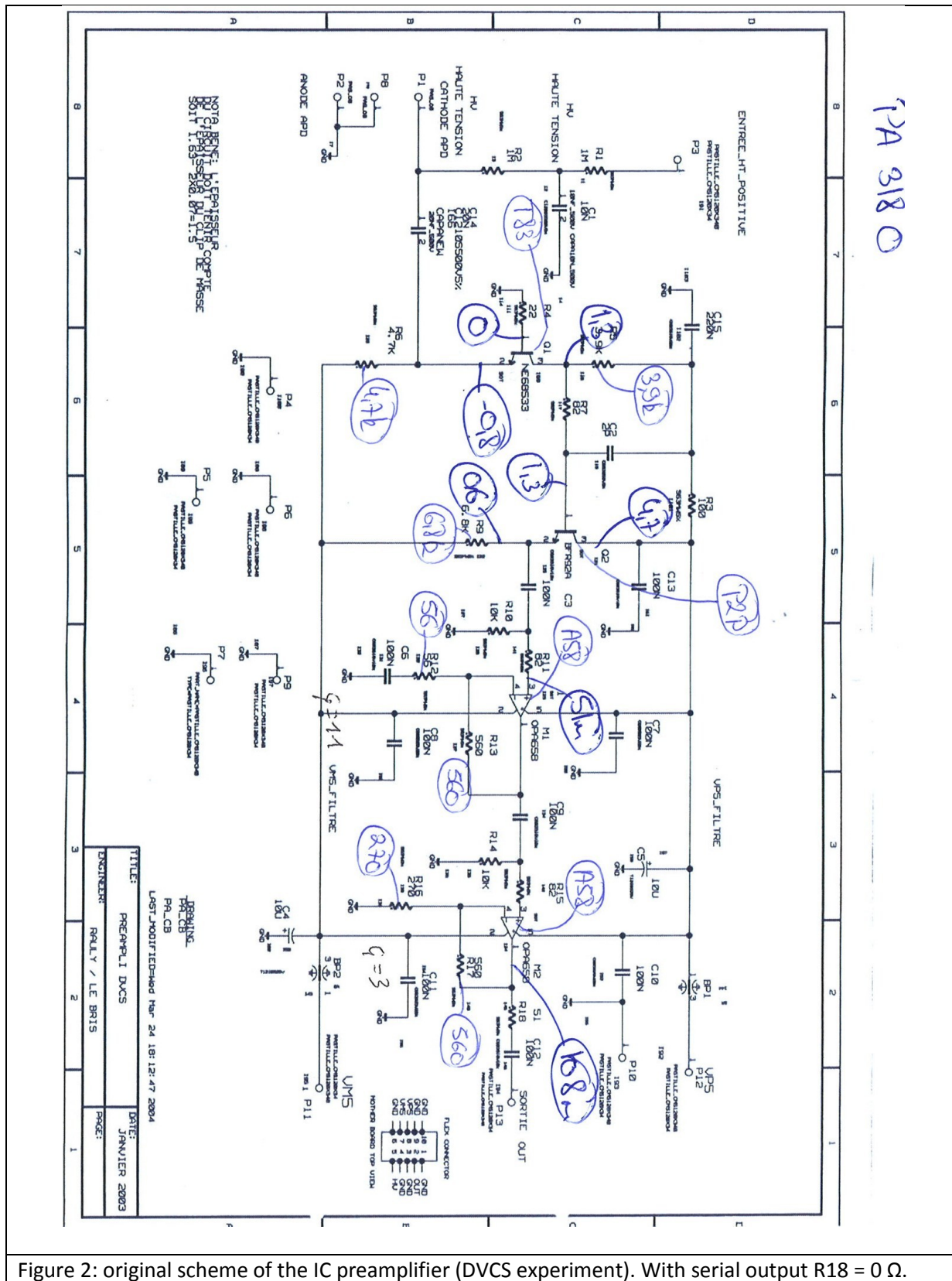

Figure 2: original scheme of the IC preamplifier (DVCS experiment). With serial output R18 = 0 Ω .

The figures 3a (for $Q_{in}=0.6pC$) and 3b (for saturation) give the output signals (yellow) for the preamplifier N318 (original DVCS IC) and for 20ns input pulse-width. This 0.6pC input charge corresponds to about 3 GeV in the crystal for $5 \times 5 \text{ mm}^2$ APD (assumptions: APD gain=200 and 6 photo-electrons/MeV). For this energy, the output charge is 70nVxs (on 50 Ω) or 1.4nC.

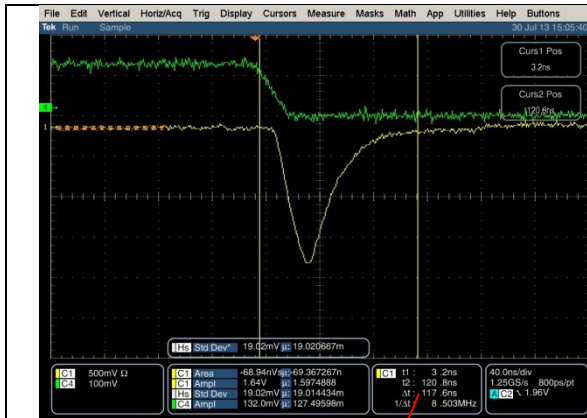

Figure 3a: output signal (yellow) of the N318 preamplifier and for 0.6pC input charge. The integration gate is about 120ns.

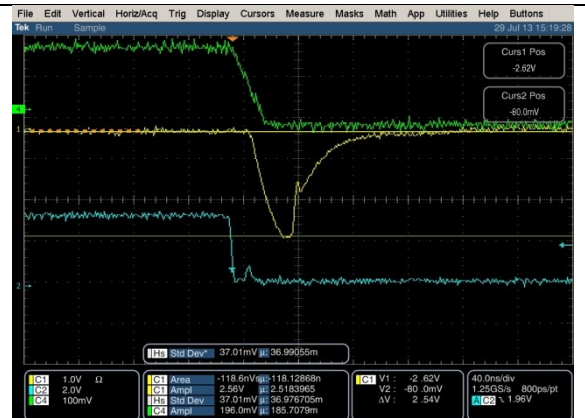

Figure 3b: saturated output signal (yellow) of the N318 preamplifier and for 0.85pC input charge.

It is worth noting that there is no saturation for 3GeV (or $Q_{in}=0.6pC$). Furthermore, the integration gate is about 120ns.

The figures 4a and 4b give the linearity curves for the preamplifier N318 respectively for input charges and input energies.

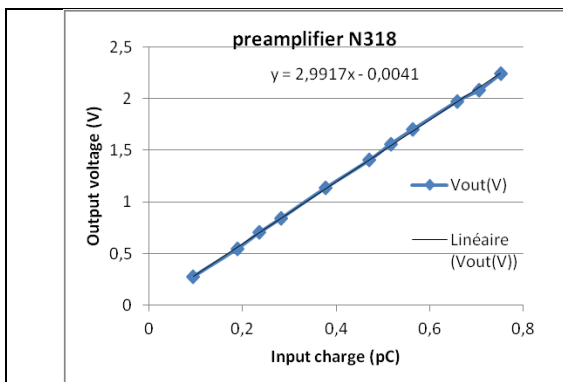

Figure 4a: output voltage (V) as a function of the input charge (pC) for the preamplifier N318. The input pulse width is 20ns. The gain is 3V/pC.

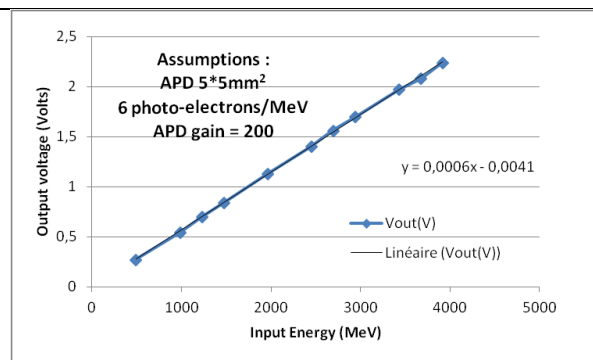

Figure 4b: output voltage (V) as a function of the input Energy in the crystal (MeV) for the preamplifier N318. The assumptions are: $5 \times 5mm^2$ APD, 6 photo-electrons/MeV and APD gain = 200. The input pulse width is 20ns.

The figures 3 and 4 can give the following characteristics or informations:

- the preamplifier gain (for 20ns input pulse width) = 3V/pC or 0.6mV/MeV (with 6 photo-electrons/MeV and APD gain = 200)
- the integration gate is about 120ns
- the output saturation is about 2.5V (for $Q_{in}=0.85pC$)

The figures 5 give the output signal (preamplifiers N318) for 6fC as input charge ($V_{in} = 1.36\text{mV}$ with 4.7pF as injection capacitance) and for 20ns input pulse-width.



Figure 5: output signal (yellow trace) of the preamplifier N318 and for 6fC as input charge. Without input capacitance.

6fC corresponds to about 30MeV in the crystal (for $5 \times 5 \text{ mm}^2$ APD, APD gain = 200 and for 6 photo-electrons/MeV).

The output noise is given on figures 6a (without input capacitance) and 6b (with 82pF input capacitance).



Figure 6a: output noise of the preamplifier N318 without input capacitance. The standard deviation is 2.2mV-RMS.



Figure 6b: output noise of the preamplifier N318 with 82pF input capacitance. The standard deviation is 4.2mV-RMS.

The output standard deviation is 2.2mV-RMS (without input capacitance). With a gain of 3V/pC, it corresponds to an input equivalent input noise of 0.00073 pC ($=2.23\text{mV}/3000$) or 0.73fC-RMS .

For 82pF input capacitance, the output noise is 4.2mV-RMS which corresponds to 1.4fC-RMS or 7.5 MeV as input noise (6 photo-electrons/MeV and APD gain = 200).

The power consumptions are: 12mA for +5V and 12mA for -5V.

The aim of the modifications is:

- to increase the bandwidth to fit in a 50ns integration gate
- to detect 3GeV in the crystal for 2V output dynamic
- to detect the minimum energy of 10 MeV

In this paper, the reference preamplifier will be the N318 and we will modify the others N340, N346, N363, FT22 and N055.

3/ Use of Hamamatsu 5x5 mm² APD : preamplifiers modification

3.1/ Introduction

If we consider the coupling between the crystal and the 5x5 mm² APD (geometry, gluing and quantum efficiency), we assume that we have an underestimated transfer coefficient of 6 photo-electrons/MeV before multiplication. The maximum theoretical value is close to 8.8 photo-electrons/MeV. The suggested APD gain is equal to 200 but can be modified (**to be confirmed**). The detector capacitance should be 80pF.

If we assume 6 photo-electrons/MeV:

10MeV in the crystal corresponds to 1.9fC (=10x6x200x1.6x10⁻¹⁹) at the preamplifier input.

3GeV in the crystal corresponds to 0.576pC (=3000x6x200x1.6x10⁻¹⁹) at the preamplifier input.

3.2/ modification of the preamplifier N363

The proposed simple modification (preamplifier N363) consists to remove a compensation capacitance (M1 = M2 = OPA658 and C2=NC). The figure 7 gives results for an input charge of 0.6pC and also for an equivalent input capacitance of 82pF.

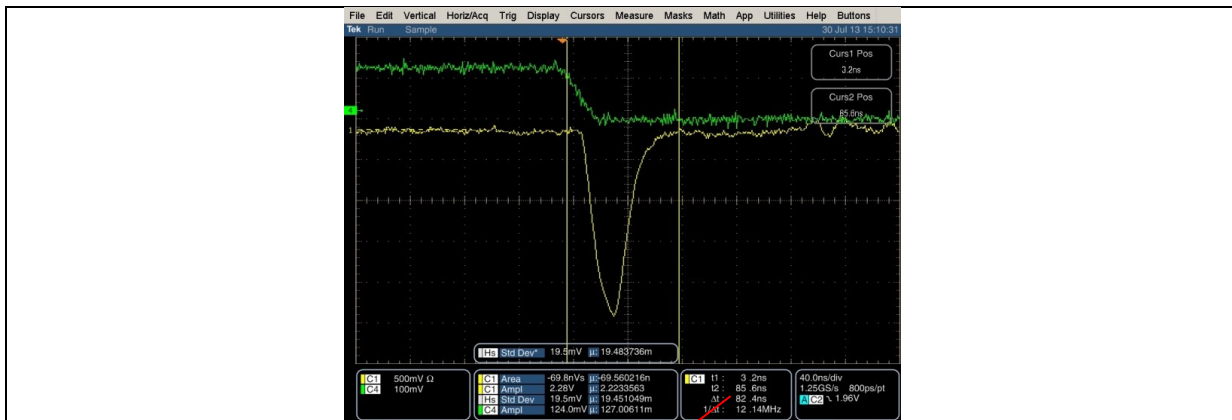

Figure 7: output signal for 0.6pC as input charge and for an equivalent input capacitance of 82pF. Preamplifier N363. The integration gate is close to 82ns.

The figures 8a and 8b give the differences in term of noise respectively for an input capacitance of 0pF and 82pF and for the modified N363 preamplifier (M1 = M2 = OPA658 and C2=NC).

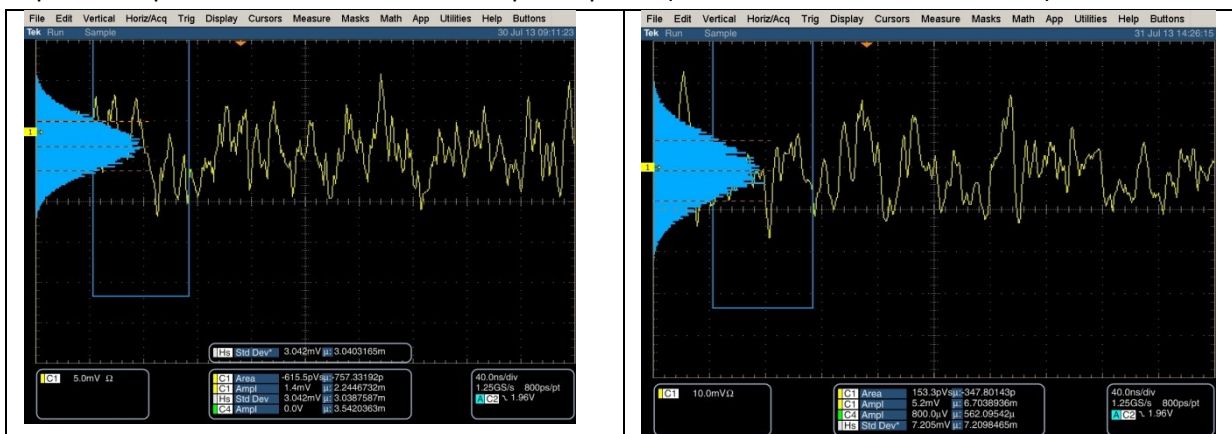

Figure 8a: output noise for the modified N363 preamplifier with M1=OPA658 and C2=NC and without input capacitance. The output noise is 3mV-RMS.

Figure 8b: output noise for the modified N363 preamplifier with M1=OPA658 and C2=NC for 82pF input capacitance. The output noise is 7.2mV-RMS.

The figure 9 gives a very low signal. The corresponding input charge is about 7.7fC or 40 MeV (APD gain =200 and 6 photo-electrons/MeV). The detailed formula is:
 $40\text{MeV} \times 6 \times 200 = 48000 \text{ electrons or } 7.7\text{fC}$



Figure 9: Output signal for $Q_{in} = 7.7\text{fC}$ ($V_{in} = 1.64\text{mV}$ and 4.7pF). The output signal is about 40mV.

3.3/ modification of the preamplifier N346

The modifications for the preamplifier N346 are the following (with respect to the scheme figure 2):

$Q1 = Q2 = \text{BFR182}$, $C2 = \text{NC}$, $R6 = 4.7\text{k}\Omega$.

The main informations are given on figures 10a (integration gate = 75ns) and 10b (linearity curve).

If we look at the figure 10a, the integration gate could be probably reduced at 65ns.

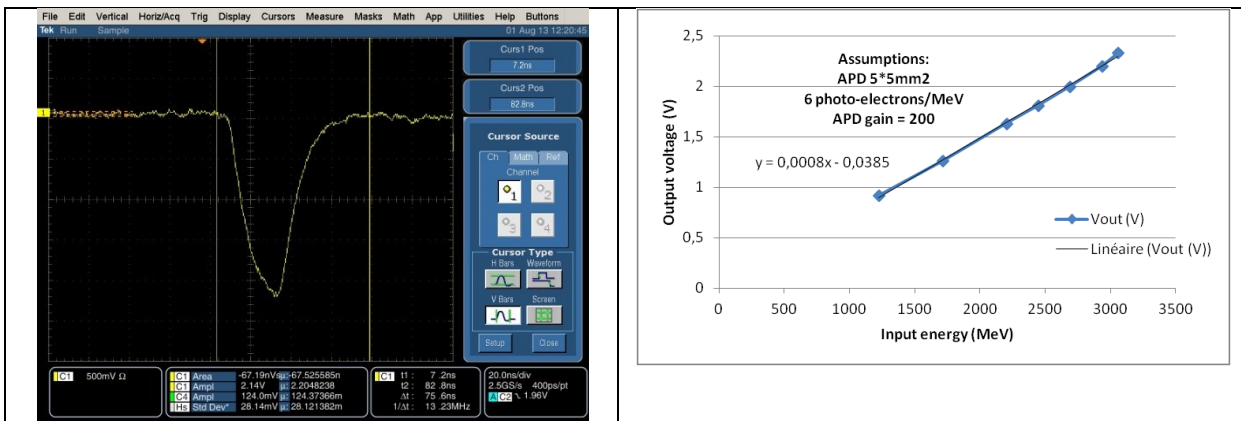

Figure 10a: output signal for an input charge of 0.6pC (or 3GeV). The estimated integration gate is 75ns.

Figure 10b: output voltage as a function of the input energy. The gain is 0.8mV/MeV.

For this energy (3GeV), the output charge is about 67nVxs (on 50Ω) or 1.3nC.

For an input capacitance of 82pF, the output noise is 6.6mV which corresponds to an estimated input noise of 8.2MeV (with 6 photo-electrons/MeV and with APD gain = 200).

4/ Use of Hamamatsu 10×10 mm² APD

4.1/ Introduction

If we consider the coupling between the crystal and the 10×10 mm² APD (geometry, gluing and quantum efficiency), we assume that we have an underestimated transfer coefficient of 25 photo-electrons/MeV before multiplication. For 10×10 mm² APD, if the wrapping and the gluing are done carefully, the transfer coefficient could reach 35 photo-electrons/MeV. The suggested APD gain is equal to 150 but can be modified (**to be confirmed**). The APD capacitance should be 270pF.

In the following, the transfer coefficient is assumed to be 25 photo-electrons/MeV.

10MeV in the crystal corresponds to 6fC ($= 10 \times 25 \times 150 \times 1.6 \times 10^{-19}$) at the preamplifier input.

3GeV in the crystal corresponds to 1.8pC ($=3000 \times 25 \times 150 \times 1.6 \times 10^{-19}$) at the preamplifier input.

4.2/ Modification of the FT22 CLAS12 preamplifier

The aim is to modify FT CLAS12 preamplifiers (some preamplifiers are kept at IPN Orsay).

The new scheme is given on figure 11 (as compared to the original scheme on figure 2).

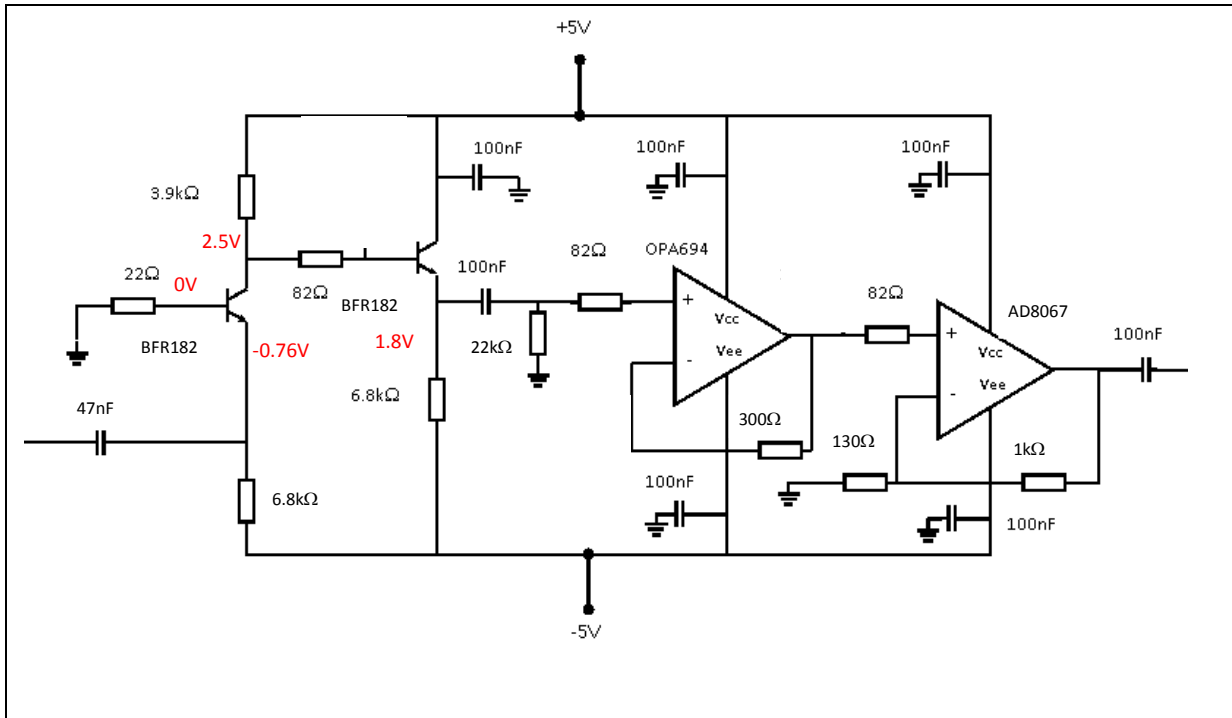

Figure 11: New scheme to fit to $10 \times 10 \text{ mm}^2$ APD based on CLAS12 FT preamplifiers.

The main modifications on the FT22 preamplifier are the following:

Q1=Q2=BFR182, M1=OPA694, M2=AD8067 (rail to rail amplifier)

R5=3.9kΩ (collector resistance of the input transistor)

R6=6.8kΩ (emitter resistance of the input transistor)

R10=22kΩ, R12=NC, R13=300Ω, R17=1kΩ, R16=130Ω, C9=0Ω, R14=NC, C2=NC

Some measured DC points are also written on the scheme.

The figure 12 gives the output signal (yellow) for an input charge of 1.8pC . It corresponds to about 3GeV with the following assumptions: 25 photo-electrons, APD gain = 150.

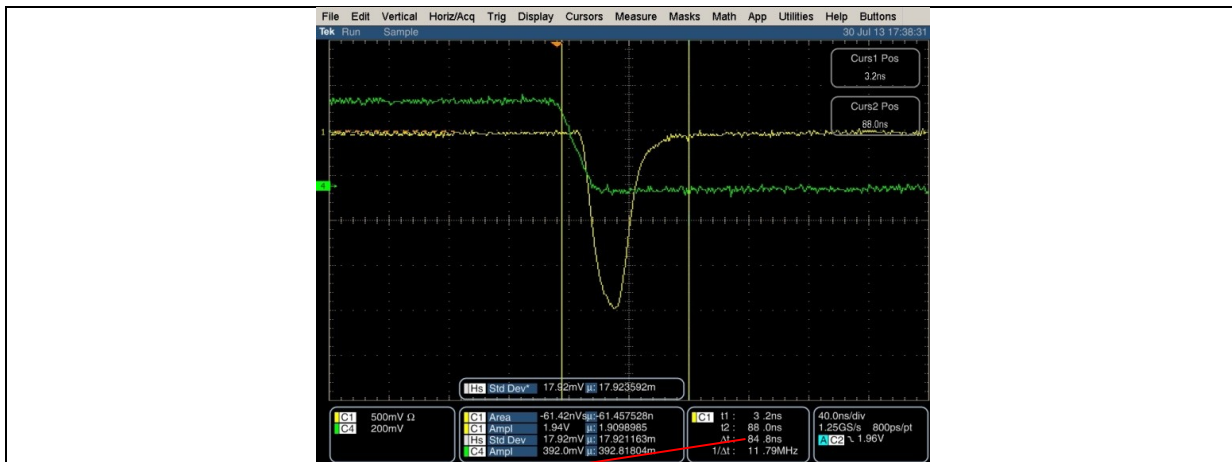

Figure 12: Output signal (yellow) for an input charge of 1.8pC . The peak voltage is 2V and the integration gate is 85ns. The input pulse width is 20ns

For this energy (3GeV), the output charge is about $62\text{nV} \times \text{s}$ (on 50Ω) or 1.24nC .

The peak voltage is about 2V for an input charge of 1.8pC. Then the estimated gain is about 1.1V/pC for 20ns input pulse width.

Furthermore, the estimated integration gate is 85ns. If we have a look at the figure 12, this integration gate could probably be optimized and reduced at 65ns.

The figure 13a gives the output noise without input capacitance whereas the figure 13b represents this noise with a 270pF input capacitance (close to the APD capacitance).

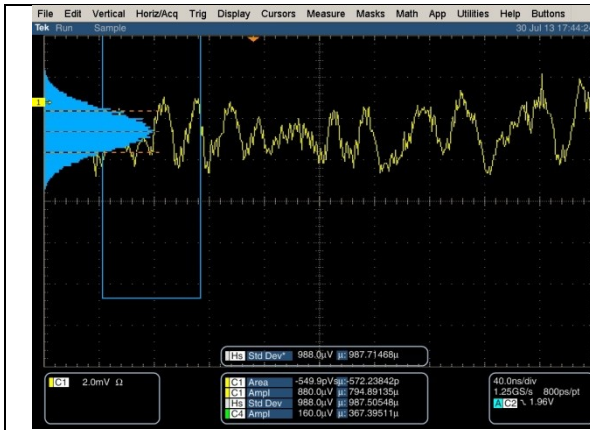

Figure 12a: output noise of the modified FT22 preamplifier without input capacitance. The output noise is 987µV-RMS.

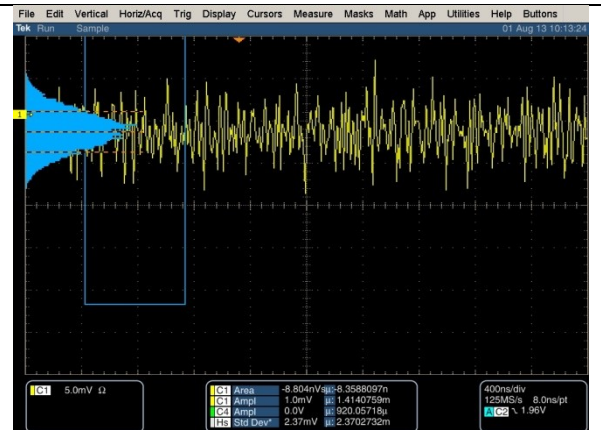

Figure 12b: output noise of the modified FT22 preamplifier with 270pF as input capacitance. The output noise is 2.4mV-RMS.

The figure 13a and 13b give the linearity curves with respect to input charge and Energy.

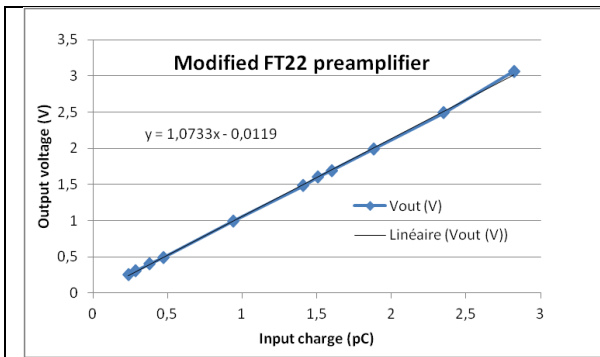

Figure 13a: output voltage as a function of the input charge for the modified scheme of figure 11. The gain is 1 V/pC.

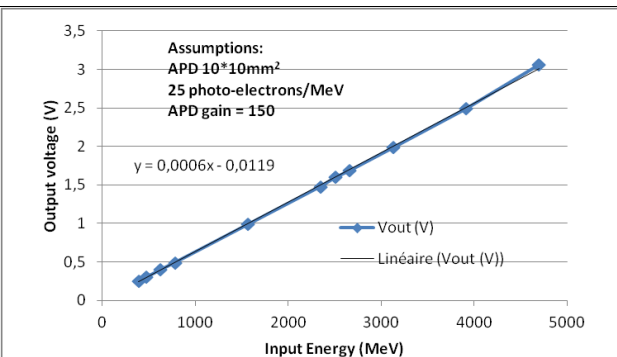

Figure 13b: output voltage as a function of the input energy for the modified scheme of figure 11. The gain is 0.6mV/MeV.

For a 270pF detector capacitance, the output noise is 2.4mV (figure 12b) which corresponds to an input noise of 3 MeV (25 photo-electrons/MeV and APD gain = 150).

4.3/ Modification of the N055 IC preamplifier

Minor changes made to the original scheme (of figure 2) are the following:

- Q1=Q2=BFR182
- C2=NC
- R12=75Ω
- R16=NC

The corresponding scheme is given on figure 14.

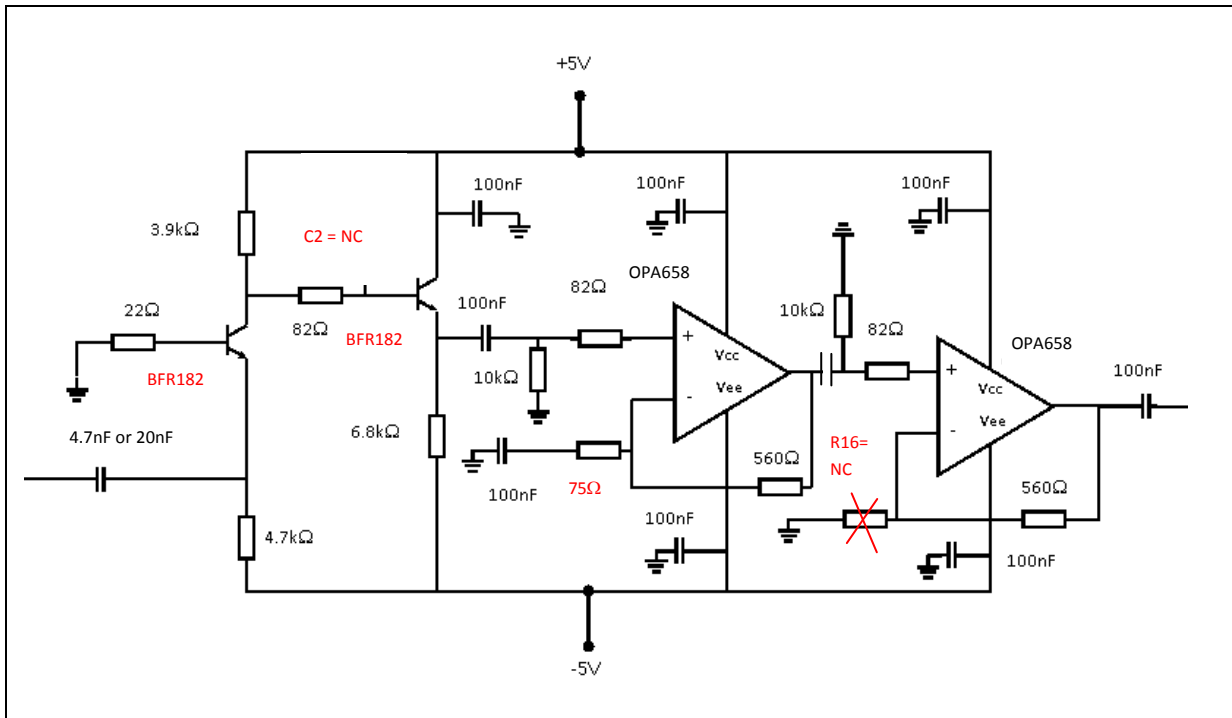

Figure 14: Modified scheme to increase the bandwidth and to fit to 10×10 mm² APD. Preamplifier number N055. In red the modifications have to be compared to the scheme of figure 2 on page 3.

The figure 15a gives the output signal for an input charge of 1.8pC or an input energy of 3GeV (25 photo-electrons/MeV and APD gain =150). The integration gate is 75ns and could be probably less (65ns).

The figure 15b gives the output noise for an input capacitance of 270pF.

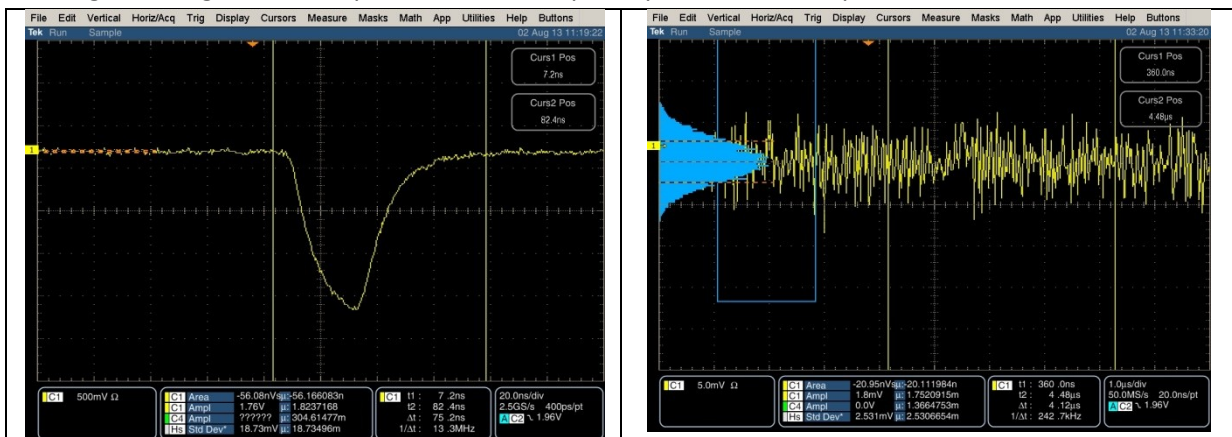

Figure 15a: output signal for an input energy of 3GeV (25 photo-electrons/MeV and APD gain =150). The integration gate is 75ns. Preamplifier N055 of the figure 14.

Figure 15b: output noise for an input capacitance of 270pF. The output noise is 2.5mV-RMS.

For this energy (3GeV), the output charge is about 56nV×s (on 50Ω) or 1.1nC.

The linearity curves are given on figures 16a and 16b.

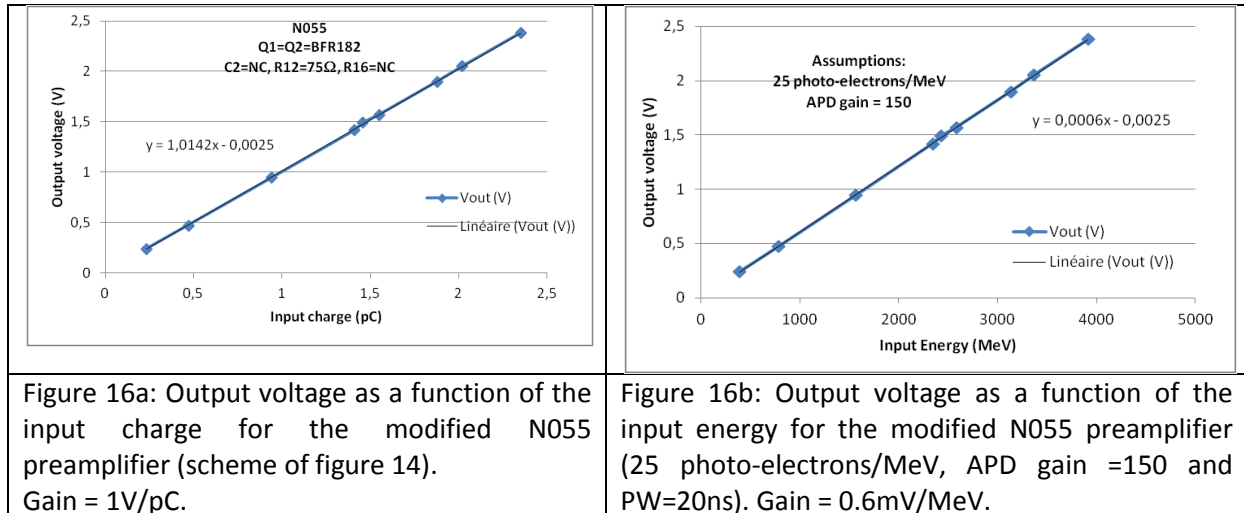

Figure 16a: Output voltage as a function of the input charge for the modified N055 preamplifier (scheme of figure 14). Gain = 1V/pC.

Figure 16b: Output voltage as a function of the input energy for the modified N055 preamplifier (25 photo-electrons/MeV, APD gain =150 and PW=20ns). Gain = 0.6mV/MeV.

The output noise is 2.5mV-RMS which corresponds to an input RMS noise of 4.2MeV (25 photo-electrons/MeV, APD gain =150 and PW=20ns).

5/ Summary

5.1/ Summary for APD 5×5 mm² configuration

In the following chart, the assumptions are:

- Input pulse width = 20ns
- 6 photo-electrons/MeV before multiplication
- APD gain =200

Preamplifier number	N318 (original IC)	N363 (page 6)	N346 (page 7)
Preamplifier modifications	No modification, cf figure 2 C2=2pF, Q1=NE68533 Q2=BFR92, M1=OPA658	Figure 2 with C2=NC	Figure 2 with C2=NC Q1=Q2 = BFR182 R6=4.7kΩ
Gain (V/pC) PW=20ns	3V/pC	3V/pC	4V/pC
Gain (mV/MeV) PW=20ns	0.6mV/MeV	0.6mV/MeV	0.8mV/MeV
Output voltage (V) for Ein=3GeV	1.7V	2.2V	2.2V
Estimated integration gate (ns)	120ns	82ns	75ns or 65ns (to confirm)
Measured RMS output noise without detector capacitance (mV)	2.2mV	3mV	3mV
Measured RMS output noise with 82pF detector capacitance (mV-RMS)	4.2mV	7.2mV	6.6mV
Estimated RMS input noise without detector capacitance (MeV)	3.7MeV	5MeV	3.9MeV
Estimated RMS input noise with 82pF detector capacitance (MeV)	7.5 Mev	12MeV	8.2MeV

5.2/ Summary for APD 10×10 mm² configuration

In the following chart, the assumptions are:

- Input pulse width = 20ns
- 25 photo-electrons/MeV (except notified)
- APD gain =150

Preamplifier number	FT22 (page 8)	N055 (pages 9-11)	N055 (pages 9-11)
Assumptions	25ph-e/MeV	25ph-e/MeV	35ph-e/MeV
Preamplifier main modifications	C2=NC, Q1=Q2=BFR182 , M1=OPA694, M2 = AD8067	Q1=Q2=BFR182 C2=NC R12=75Ω R16=NC	Q1=Q2=BFR182 C2=NC R12=75Ω R16=NC
Gain (V/pC) PW=20ns	1V/pC	1V/pC	1V/pC
Gain (mV/MeV) PW=20ns	0.6mV/MeV	0.6mV/MeV	0.9mV/MeV
Output voltage (V) for Ein=3GeV	1.9V	1.9V	2.5V
Estimated integration gate (ns)	85ns and probably 65ns	75ns and probably 65ns (to confirm)	75ns and probably 65ns (to confirm)
Measured output noise with 270pF detector capacitance (mV-RMS)	2.4mV	2.5mV	2.5mV
Estimated RMS input noise with 270pF detector capacitance (MeV)	4MeV	4.2MeV	2.7MeV

6/ Partial conclusion

- With the use of the APD 5×5mm², the modified preamplifier N346 (see chart paragraph 5.1/, page 11) seems to give the best characteristics: integration gate = **65ns** and estimated input RMS noise = **8.2MeV**.
- However, the desired integration gate of 50ns was not reached.
- With the use of the APD 5×5mm², or APD 10×10mm² the minimum detected energy is strongly dependent on the transfer coefficient and also of the APD gain. It is not possible to conclude.
- With the use of the APD 10×10mm², the modified preamplifier N055 (pages 9-11) seems to give good characteristics: integration gate down to = **65ns** (to be confirmed) and estimated input RMS noise = **4.2MeV**.
- The noise (in MeV) is also strongly dependent on the transfer coefficient (see summary 5.2/)
- For this preamplifier N055, the modifications of the original IC preamp are minor (Q1=Q2=BFR182, C2=NC, R12=75Ω, R16=NC)
- The input noise (in MeV) is the lowest if we use the APD 10×10mm²