

Contents

About QuickSilver Controls, Inc.

QuickSilver Controls manufactures products to provide servo control for microstep motors. The SilverNugget™ and SilverDust™ are single axis, servo controller/driver modules designed to servo QuickSilver's line of NEMA 17, 23, and 34 motors.

Visit the QCI website for the latest product information, software updates, manual revisions, and application notes.

QCI products are sold worldwide through motion control distributors.

909-447-7417

888-660-3801

Fax: 909-447-7410

Website:

www.QuickSilverControls.com

E-mail:

Sales@QuickSilverControls.com

Support:

Support@QuickSilverControls.com

Introduction	1
Servoing a Stepmotor	2
Key Features	3
Command Set Summary	4
QuickControl® Software	5
Start-Up Kits	7
Basic Design Guide	9
SilverDust I-Grade IG & IGB	11
SilverDust MG	15
SilverNugget N2 & N3	17
17 Frame Motor/Encoder	19
23 Frame Motor/Encoder	21
17 & 23 IP65 Motor/Encoder	23
34 Frame Motor/Encoder	25
Cables	27
Accessories	28
Optical I/O Modules	29
Breakouts	30
Clamp Modules	31
Other Resources	33
Conversion Tables	34
Warnings	35

Introduction

Data and Specifications

This catalog gives general specification and is not meant to be used for design purposes. QCI provides detailed datasheets and technical documents on our website to aid in the design process.

Data and specification provided in this catalog are believed to be free from errors as of the date of this printing, but are subject to change without notice. QuickSilver Controls is not liable for errors or omissions in this catalog. The latest up-to-date information sheets for all products may be found at www.QuickSilverControls.com. Please also see the Warnings section on the last page of this catalog.

Notes on Motor Specifications

The following are some notes about the motor/encoder specifications listed later in this catalog.

Torque Curves

With regard to the torque curves given in this catalog, “48V Max” is the torque of the motor when the Torque Limits (TQL) command is set to “Max” (see SilverLode Command Reference for details on the TQL command). Operating the motor in this mode may require additional heat sinking on the Controller/Driver and motor to prevent overheating.

All other torque curves represent motor torque at the specified voltage when the TQL command is set to “100%”. These curves represent torque up to 100% duty cycle depending on ambient temperature, heat sinking and air flow.

Important: There is a slight reduction in torque if a shaft seal is used due to the friction of the shaft seal.

Optimal Speed

The Optimal Speed is provided by QCI as a guideline for highest mechanical output power and efficiency. It is specified for a 48v power supply.

Power Supply Current:

The power supply current drawn is a function of power supply voltage, speed, and torque. The controller power supply uses one or more high efficiency switch mode power converters to convert the input voltage down to the voltage needed by the electronics. For example, a 2W electronics load, which could be 350mA @ 5v plus conversion losses, this would require some 41mA from a 48v supply, while it would require 167mA from a 12v supply.

The same holds for the motor driver, which is essentially a bi-directional switch mode converter. If a stationary motor with a 1.2 ohm winding circuit resistance is driven with 2A at the windings, this would dissipate some $2^2 \cdot 1.2 = 4.8w$. This would draw some 100mA at 48v or 400mA at 12v. However if the motor is spinning and producing torque, additional electrical input power is required to balance the added output power (plus additional losses due to friction, etc.). For a motor producing 100w of mechanical power at 90% efficiency, with the windings still operating at the same 2A, this would add 111w to the input power requirement, requiring an additional 2.3A at 48v. At 12v, it would require 9.2A, which is beyond the input current ratings of any N2 controller/driver, so this level of mechanical output power would not be available when operating at 12v for the example system. Please see the data sheets on the webpage for torque-speed-supply voltage-current details.

Servoing a Stepmotor

What is a “Servo”?

The Merriam-Webster Dictionary defines:

servomechanism - an automatic device for controlling large amounts of power by means of very small amounts of power and automatically correcting the performance of a mechanism.

History

One of the earliest known servomechanisms dates back to around 270BC and was a regulator for the water level used for the water clocks to help them keep more accurate time by keeping the water level constant. The constant level produced constant pressure and thus constant flow through a fixed orifice. The time to fill a fixed volume container until it flipped and emptied defined a constant time tick for their clock.

This float mechanism worked similarly to the float mechanism used in current day toilet tanks. In this case, the feedback is in the form of the level of the float, and that difference in level operates a valve so as to keep the water level within the desired range.

Servo motion control systems use position and/or velocity sensors to measure the difference between the desired and actual operation of the actuator. Amplifiers (electronic, mechanical, hydraulic, magnetic, etc.) are used to increase the power of the error signal and to affect the operation of the actuator so as to make the actuator perform the desired motion. The SilverLode™ systems use optical incremental encoders to measure the motor rotary position, digital signal processors to process it, and drive electronics to provide the power drive to the motor to effect the motion.

Are they Servos or Steppers?

Both! By common usage, Servomotor describes a motor that can provide good closed loop performance when attached to a servo controller/driver while Stepmotor describes a motor that can perform good open loop performance when attached to an open loop controller/driver. In the absence of a controller/driver both are essentially paper-weights! The term "Servomotor" generally denotes a motor having those characteristics useful when combined into a servo system: low detent or un-powered cogging torque, uniform commutated

torque as a function of angle, high torque capability with respect to rotor inertia, a stiff structure with respect to torque capability, and the ability to readily dissipate waste heat. The modern microstep motor has all of these characteristics as well as the ability to be operated open loop, but the servo qualities remain underutilized unless the motor is attached to the appropriate electronics. When operated in closed loop servo mode, these motors operate much more efficiently than when operated in open loop mode, allowing them to produce more usable torque while remaining cooler.

What is This Anti-Hunt™ Stuff?

Just because the motor can be operated as a high performance servo system does not mean that it cannot be switched back to its humble open loop beginnings. When the motor is sufficiently close to the desired position, the operating mode of the motor can be switched to open loop operation at a user defined current level. With the servo loop turned off, the hunting or dithering of the servo loop is eliminated. If the motor position is disturbed or another motion is requested, the servo operation is restored.

For more details, see the white paper “QCI-WP003 Servo Control Of a Microstep Motor” on our website.

Key Features

Point-to-Point Moves

- Relative or Absolute
- Velocity or Time Based
- S-Curve

Advanced Motion Profile Moves

- Profile Move Commands
- Register Based
 - Position
 - Acceleration/Deceleration
 - Velocity
 - Modify On-the-Fly

I/O

- Up To 23 Depending On Controller
- Bi-directional
- Set While In Motion
- Used For Such Things As:
 - Stopping/Starting Moves
 - Program Flow
- 4 Analog Inputs

Program and Data Storage

- 32K Non-Volatile Memory
- 2000-3000 Program Lines
- User Data Examples
 - Cam Tables
 - Motion Profiles
 - Lookup Tables

Electronic Gearing/Camming

- Follow External Signals
 - Encoder (A/B Quadrature)
 - Step and Direction
- Dynamic Scaling (Gear Ratio)
- Electronic Cam
 - Import Cam Table From Text File
 - Up to 800 Points (Program Dependent)
 - Multiple Tables

Electronic Slip Clutch/Brake

- Variable Torque
- Wind/Unwind Applications

Communication

- RS-232/RS-485
- Networkable
- Up To 230K Baud
- Host Control While Servo In Motion

Programming Language

- Easy To Use
 - Menu Driven
 - Graphical
 - Command Parameter Prompts
 - No Syntax Errors
- Powerful

Advance PVIA™ Servo Loop

- 100:1 Inertial Mismatch
- Direct Drive Oversized Inertial Loads
 - Flywheels
 - Belt Drives
 - Typically Without Gearheads
- Improved Stability Over PID

Anti-Hunt™

- Optional Mode: Go Open Loop When Holding
- No Servo Dither While At Rest
- Useful Applications Include:
 - Microscope Positioning
 - Antenna Positioning
 - Camera Positioning

Record and Playback

- Store Data While In Motion
- Load Data for Playback/Analysis

Motor/Encoders

- NEMA 17 Frame
 - 8000 Counts/Rev
 - Up To 50 oz-in
 - IP65
- NEMA 23 Frame
 - 8000 Counts/Rev
 - Up To 380 oz-in
 - IP65
- NEMA 34 Frame
 - 16000 Counts/Rev
 - Up To 3200 oz-in

UL Recognition Mark - US + Canada CE Mark



Command Set Summary

Status Commands

- Internal Status
- Error Conditions
- I/O States
- Data Registers Including
 - Position
 - Velocity
 - Torque
 - Voltage
 - Temperature

Override Commands

- Stop
- Restart

Initialization Commands

- Serial Interface: RS-232 or RS-485
- Multi-drop
- Baud Rate
- Protocol: 8-Bit ASCII, 9-Bit Binary or Modbus®
- Network Address
- Servo Control Constants
- Torque Limits
- Shutdown and Recovery
- Over and Under Voltage Trips
- Over Temperature Trips
- Position Error Limits
- End of Travel Limits
- Driver Enable/Disable
- Multi-Tasking
- Dual Loop
- Drag Mode (Slip Clutch)

Mode Commands

- Input Mode: Use Analog Input To Control Position, Velocity or Torque
- Follow External Encoder or Step & Direction
- Velocity Mode

Motion & Profile Move Commands

- Move Relative, Time Based
- Move Relative, Velocity Based
- Move Absolute, Time Based
- Move Absolute, Velocity Based
- Register Based Moves
- Linear and S-Curve Acceleration
- Profile Move: Change Position, Acceleration and Velocity On the Fly

Program Flow Commands

- Conditional Jumps
 - Input State
 - Last Calculation Result
 - Register Value
- Wait on Inputs
- Delay Timer
- Subroutines
- Load and Run Program From Non-volatile Memory

I/O Commands

- Read Input
 - Single Input
 - Register Based
 - Stop/Start
- Set/Clear Output
- Analog Read
 - Continuous
 - Immediate

Data Register Commands

- Math Functions Including:
 - Add, Subtract, Multiply, and Divide
 - AND, OR, and Exclusive OR
 - Absolute Value
 - Bit Shifting
- Indirect Addressing
- Word/Byte Manipulation
- Store Register To Nonvolatile Memory
- Load Register From Nonvolatile Memory
- Import Data From Text File

Misc. Commands

- Clear Status
- Zero Encoder

Need A Custom Command

QuickSilver has a long history of designing and manufacturing servo systems to meet the specific requirements of our customers. We have our own in-house development team, which allows a fast turn on custom software and firmware development for OEM customers.

QuickControl® allows developers to quickly program and operate all SilverLode controller/drivers using a standard PC running Windows (9x, Me, NT, 2K, or XP). Communication to the device is accomplished from the PC's serial port (i.e. COM1 or COM2). QuickControl also provides tools for uploading and downloading programs and user data. Data can be typed in manually or imported from text files. Documentation features include remarks, line labels, custom register and I/O names.

Initialization Wizard

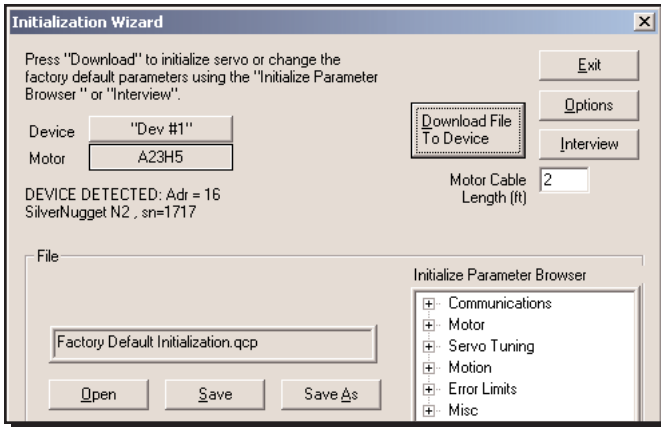

Using this wizard, the developer can rapidly initialize any SilverLode controller/driver.

Changing the network address or the baud rate is as simple as a click of a button. Any number of unique initialization files can be created, such that each servo axis can have a unique file.

Programming

QuickControl allows commands to be created and linked together in a program. Programs are edited and downloaded to the controller using the program editor. The program editor works with one or more units on a multi-axis system. QuickControl enables you to concentrate on developing the motion control for your project, rather than on writing custom software.

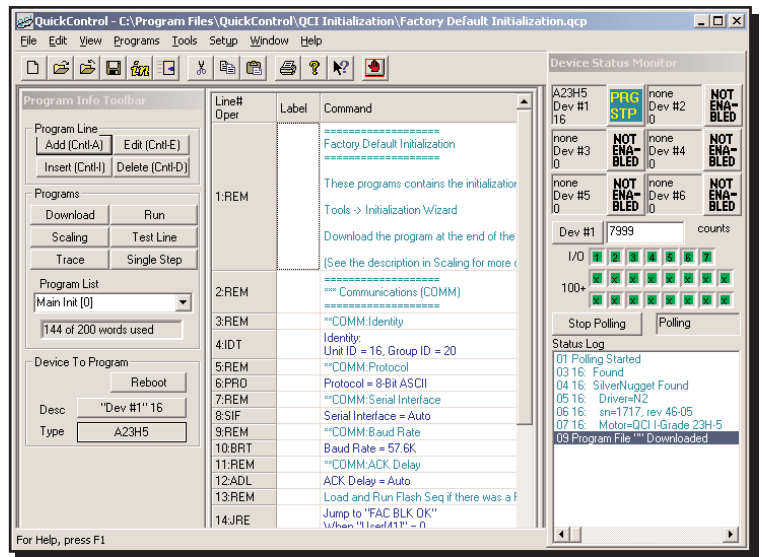

Add Commands to Your Program

Adding commands to a program is simple. Press the "Add" button and select the desired command from an easy to read list.

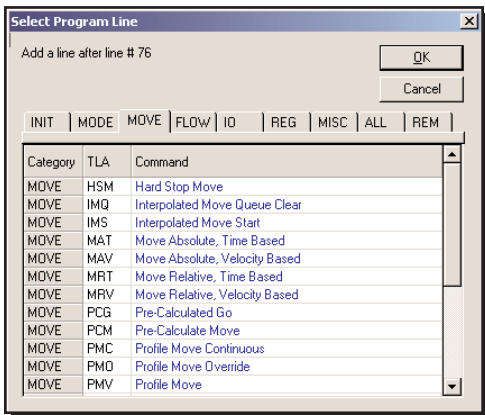

Create and Edit Motion Commands

The command edit dialog boxes allow the programmers to create and edit the commands. The dialog boxes are designed to make the commands simple to understand. In most cases, setting up a command is as simple as filling in a well-defined data parameter or selecting an option.

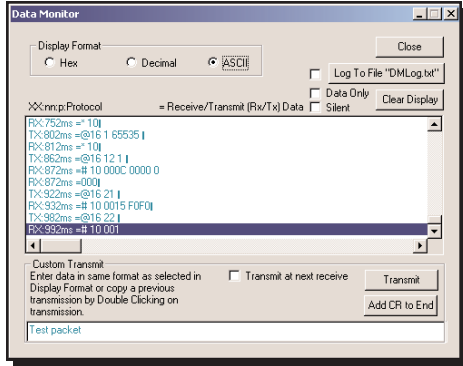
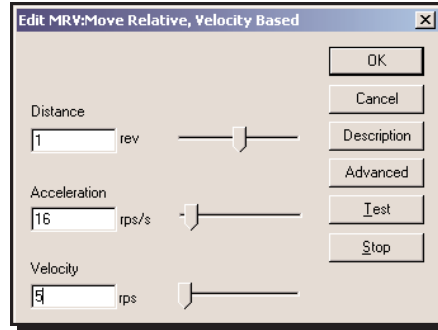

Monitor Communication Data

For developers sending commands to a servo using a PC, embedded controller or PLC, QuickControl provides the Data Monitor tool. This tool displays all traffic on the communication line. Logging to a text file is available. Programmers can test their own packets using the Custom Transmit feature.

Control Panel

Use the Control Panel to monitor and "Jog" the servo. This allows the developer to determine an axis' end of travel, range, acceptable acceleration and velocity. The tool displays, I/O states, analog input voltages and extended device status. The tool also allows the user to set and clear outputs. To tune the PVIA servo loop, the developer can initiate motions, view the results on the Strip Chart and modify the tuning parameters on the fly.

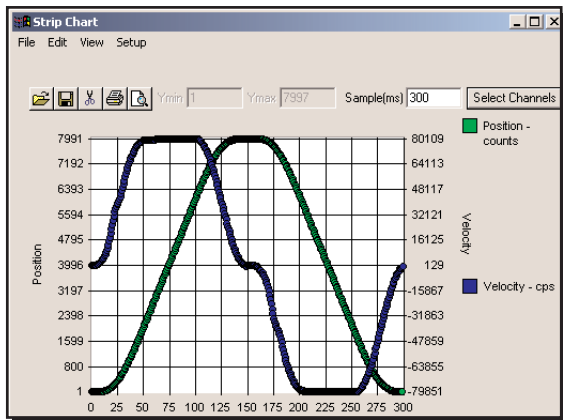
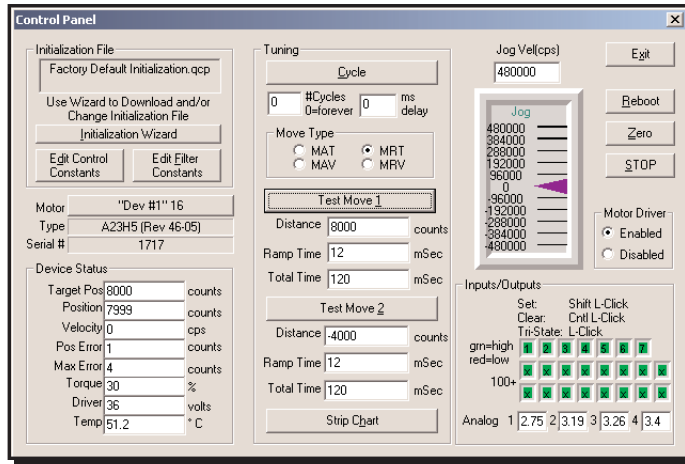

Strip Chart

The Strip Chart tool can be used to simultaneously chart up to four channels such as "Actual Position," "Target Position," "Velocity," and "Torque." Data can be converted to text or imported into a spreadsheet for analysis.

Start-Up Kits

For first time users, we recommend buying one of the following Start-Up kits. Each kit contains a SilverLode controller/driver and the components required to “get started”. This includes the SilverLode User Manual, SilverLode Command Reference and QuickControl programming software.

Note: Start-Up kits **DO NOT** include motor/encoder or power supply.

QCI-SK-D2-IGB

Start-Up with SilverDust D2 IGB. This kit is for any 17/23 I-Grade motor/encoder. This Start-Up kit provides all the necessary breakouts for power, I/Os, communication for a complete system along with 16, 5-24V, isolated I/O.

This kit includes:

- (QCI-QC) QuickControl Software CD
- (QCI-SLM) User Manual & Command Reference
- (QCI-C-D9M9F-6) Communication Cable
- (QCI-C-D15P-D15S-4) 4’ DB15HD Motor I/F Cable
- (D2-G1-03-IGB) SilverDust IGB Controller/Driver

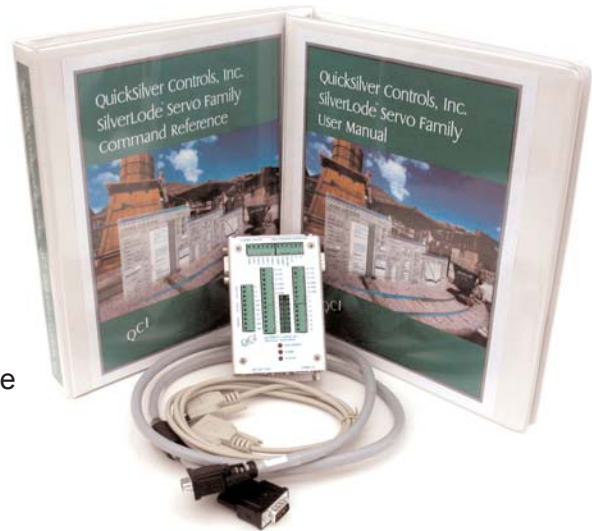

QCI-SKB-D2-IG

Start-Up Kit with SilverDust IG. This kit is for any 17/23 I-Grade motor/encoder and is the ideal OEM Start-Up kit. The controller/driver is the open frame L-Bracket version. Also provided is the Basic Breakout (QCI-BO-B) module for power, I/Os and communication.

This kit includes:

- (QCI-QC) QuickControl Software CD
- (QCI-SLM) User Manual & Command Reference
- (QCI-C-D9M9F-6) Communication Cable
- (QCI-C-D15P-D15S-4) 4’ DB15HD Motor I/F Cable
- (QCI-BO-B) Basic Breakout
- (D2-G1-02-IG) SilverDust D2 IG Controller/Driver

For detailed specifications see www.quicksilvercontrols.com

QCI-SKB-N2-EE

Start-Up Kit with SilverNugget N2. This kit is for any 17/23 I-Grade motor/encoder. The SilverNugget N2 controller/driver has an enclosed (IP50) design. Also provided is the Basic Breakout (QCI-BO-B) module for power, I/Os and communication.

This kit includes:

- (QCI-QC) QuickControl Software CD
- (QCI-SLM) User Manual & Command Reference
- (QCI-BO-B) Basic Breakout
- (QCI-C-D9M9F-6) Communication Cable
- (QCI-C-D15P-D15S-4) 4' DB15HD Motor I/F Cable
- (N2-E3-04-EE) SilverNugget N2 Controller/Driver



This kit includes:

- (QCI-QC) QuickControl Software
- (QCI-SLM) SilverLode User's Man and Command Ref
- (QCI-OPTMC-24) Optical I/O Module with Din Carrier
- (QCI-C-OP232-7) Optical I/O Module to RS232 CableDB15HD Interface Cable
- (QCI-CLCF-04) Clamp Module
- (QCI-CLRP-2) Resister Pack
- (QCI-EC-SMI-2) SMI Cable
- (QCI-34EC-LP-10) Line Power Cable
- (Cable QCI-C-D15P-D15S-4) DB15HD Motor I/F
- (QCI-C-D5P-D5S-4) DB5 Motor I/F Cable
- (N3-E3-04-EE) SilverNugget N3 Controller/Driver

QCI-SKOM-N3-EE

Start-Up Kit with SilverNugget N3. This kit is for any 34 I-Grade motor/encoder. All 34-frame systems require a Clamp Module (QCI-CLCF-04) to absorb the excess power generated by the motor during a hard stop or rapid deceleration. Also provided is a 24V, optically isolated, breakout module (QCI-OPTM-24).

Basic Design Guide

Below are basic design guides suitable for most general applications and how to select the proper Quicksilver components for a complete system.

Scenario 1:

Max speed requirements: 500 RPM

Max required torque: 25 Oz-in

Operating Voltage: 24

I/O requirement: 24 Volts

1) Motor Selection

The first step is to locate the 24 Volts torque curve for the motor type of choice. Start with the 17-1 and go down the list. Based on the 24 Volts curve of the 17-1 and 17H-1, they do not qualify. The torque-speed requirements do not fall below the curve. The next two are 17-3 and 17H-3. The 17-3 meets the design requirements and is lower in price compared to the 17H-3, therefore, it's the preferred choice in this case.

2) Controller/Driver Selection

The second step is to select the controller/driver. The major determining factors in selecting controller/driver types are environmental protection, price-performance, and application space constraint. The best controller/driver to select for this scenario is SilverDust IGB due to the 24 Volts I/O requirements. The SilverDust IG and SilverNugget N2 could work with this application through the 24 Volts Optical I/O Module QCI-OPTMC-24, however, pricing for an optical breakout module and a cable is almost equivalent to the SilverDust IGB. Performance wise, there are 9 more 24 volts I/Os on the SilverDust IGB. As far as space constraint, the SilverDust IGB is the same size as the optical breakout board.

3) Accessories Selection

The last step in selecting any system is accessory items for wiring simplicity. The most basic breakout module is the QCI-BO-B. This item mounts directly onto any existing SilverDust and SilverNugget N2 breaking out all the necessary signals. All other breakout modules will require a QCI-EC-SMI-nn cable for connection to any controller/driver unit. Selecting proper accessory items will make the system less prone to error due to improper wiring, which could lead to system damages and failures. See our website for more design related technical documents.

Below are a few frequently used systems recommended by QCI



SilverDust IGB System

1) Motor: QCI-A17-3-A-01

Motor selection depends on torque/speed requirements. Pictured is the 17-3.

2) Controller/Driver: D2-G1-03-IGB

3) Accessory: QCI-C-D15P-D15S-01

Cable length also depends on application requirements. Pictured is the one foot Motor I/F cable.

Basic Design Guide



SilverDust IG System

- 1) Motor: QCI-A23H-5-A-01

Motor selection depends on torque/speed requirements. Pictured is the 23H-5

- 2) Controller/Driver: D2-G1-02-IG

- 3) Accessories:

(QCI-C-D15P-D15S-04) Motor I/F cable pictured
(QCI-BO-B) Simple Breakout

SilverNugget N2 System

- 1) Motor: QCI-A23H-5-A-01

Motor selection depends on torque/speed requirements. Pictured is 23H-5.

- 2) Controller/Driver: N2-E3-04-EE

- 3) Accessories:

(QCI-C-D15P-D15S-01) Motor I/F cable pictured
(QCI-BO-B) Simple Breakout



SilverNugget N3 System (Not Pictured)

- 1) Motor: QCI-A34HC-1-B-01

Motor selection depends on torque requirements. Most frequently used systems and stocked items are 34HC-1 and 34HC-2.

- 2) Controller/Driver: N3-E3-04-EE

- 3) Accessories:

(QCI-OPTMC-24) Optical I/O Module with Din Carrier
(QCI-C-OP232-7) Optical I/O Module to RS232 Cable DB15HD Interface Cable
(QCI-CLCF-04) Clamp Module
(QCI-CLRP-2) Resistor Pack
(QCI-EC-SMI-2) SMI Cable
(QCI-34EC-LP-10) Line Power Cable
(Cable QCI-C-D15P-D15S-4) DB15HD Motor I/F
(QCI-C-D5P-D5S-4) DB5 Motor I/F Cable

SilverDust IG & IGB

The SilverDust I-Grade (IG) and I-Grade with Breakout (IGB) are servo controller/drivers designed to work with QCI's I-Grade motor/encoders. Features include:

- Built In Voltage Clamp and Power Resistor
- Automatically Upload Encoder/Motor Data from I-Grade Motor/Encoders.
- Secondary Encoder In/Out
- Driver Enable
- IGB Only: 16 Additional, 5-24V, Isolated I/O
- IGB Only: CAN Interface*

For more detail, download the datasheet from our website: www.quicksilvercontrols.com: QCI-DS003 SilverDust IG-IGB.

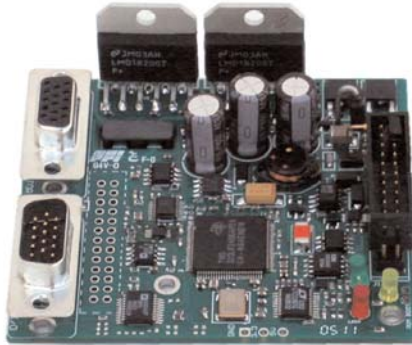

D2-G1-01-IG

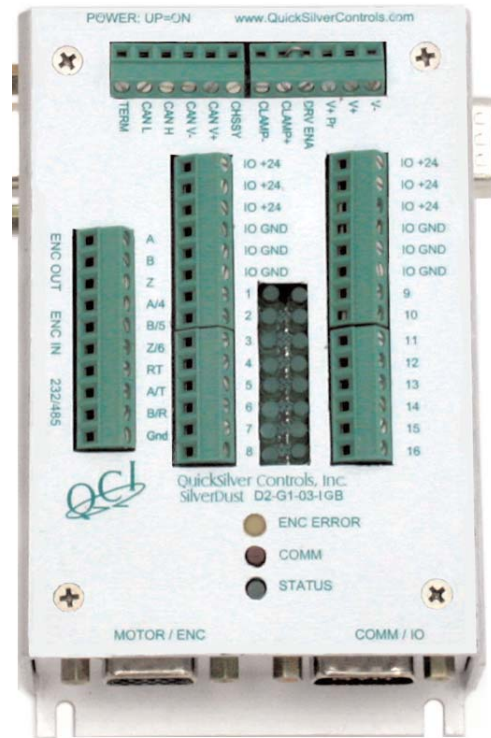

D2-G1-03-IGB

SilverDust I-Grade Controller / Driver

Driver	Controller	Options	Interface Options
D2 - 3.5 Amp • For 23 Frame and Smaller • 3.5 Amps per Phase Continuous* • 4.5 Amp Peak * Depending on heat sink (25C ambient).	G1 - Includes • RS-232 or RS-485 • Built In Voltage Clamp • 7 Inputs or Outputs • 4 Inputs Double as Analog Inputs, 0-3.3V • 32KB Non-volatile Memory	01 – Board Only • Requires user to properly heat sink.	IG - I-Grade • DB15: Motor I/F • DB15: SilverLode Multi-Function I/F (SMI)
		02 – With L-Bracket for heat sinking. • DIN compatible 03 – With Enclosure	

To create a part number, choose one from each column above.

For example:

D2	G1	03	IGB
-----------	-----------	-----------	------------

This selection creates the part number: D2-G1-03-IGB

* CAN not enabled at the time of this printing. See our website for latest details.

For detailed specifications see www.quicksilvercontrols.com

Controller / Driver Specifications

Power

- Voltage Input (12-48 VDC)
- Current Input: (4.5 Amps Max)

Communications

- RS-232/485 Single or Multi-drop
- Baud Rates: 2.4Kbps - 230Kbps (Software Configurable)
- CAN Interface*

I/O

- 16 @ 24Volts Isolated I/O Lines (-03-IGB Option Only)
- 7 @ 3.3Volts I/O Lines
- 4 Analog inputs (shared)

Driver/Amplifier

- 3.5 Amps/Phase Continuous
- 4.5 Amps/ Phase Peak

Unique Capabilities

- Encoder Hardware Error Detection
- Encoder In/Out for Electronic Gearing
- Modular Design for Multi-axis
- Built In Clamp
- Support I-Grade Motor Memory
- 1023 Words Program Buffer (RAM)
- Extended User Registers (10-199)

Mechanical Specifications

Motor

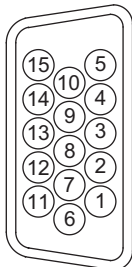

1	Motor B+
2	Chassis Ground
3	+5V Encoder Power
4	Encoder A -
5	Encoder B -
6	Motor A +
7	Motor B -
8	Encoder Z +
9	Encoder A +
10	Encoder Z -
11	Motor A -
12	Chassis Ground
13	Encoder B+
14	Encoder Ground
15	Motor Memory Access

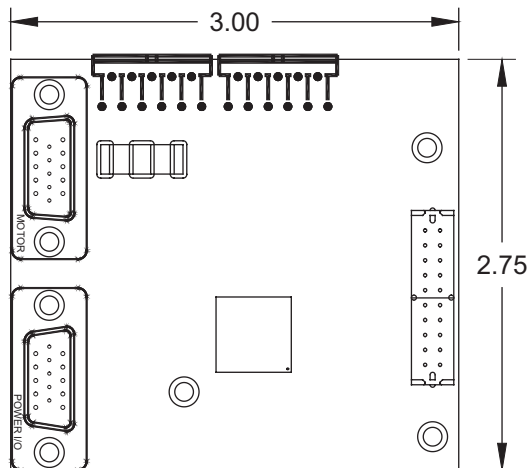

SilverLode Multi-Function Interface (SMI)

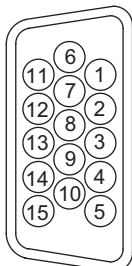

1	V+ (12-48 VDC)
2	RS-485B/RS-232 TX
3	+5V OUTPUT 100mA
4	I/O #3
5	I/O #6
6	POWER GROUND
7	V+ (12-48 VDC)
8	LOGIC GROUND
9	I/O #2
10	I/O #5
11	POWER GROUND
12	RS-485A/RS-232 RX
13	I/O #1
14	I/O #4
15	I/O #7

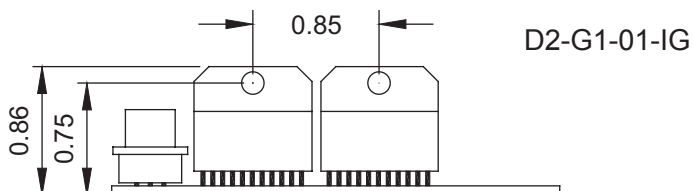

All Dimensions are in inches unless otherwise specified.

SilverDust IG & IGB

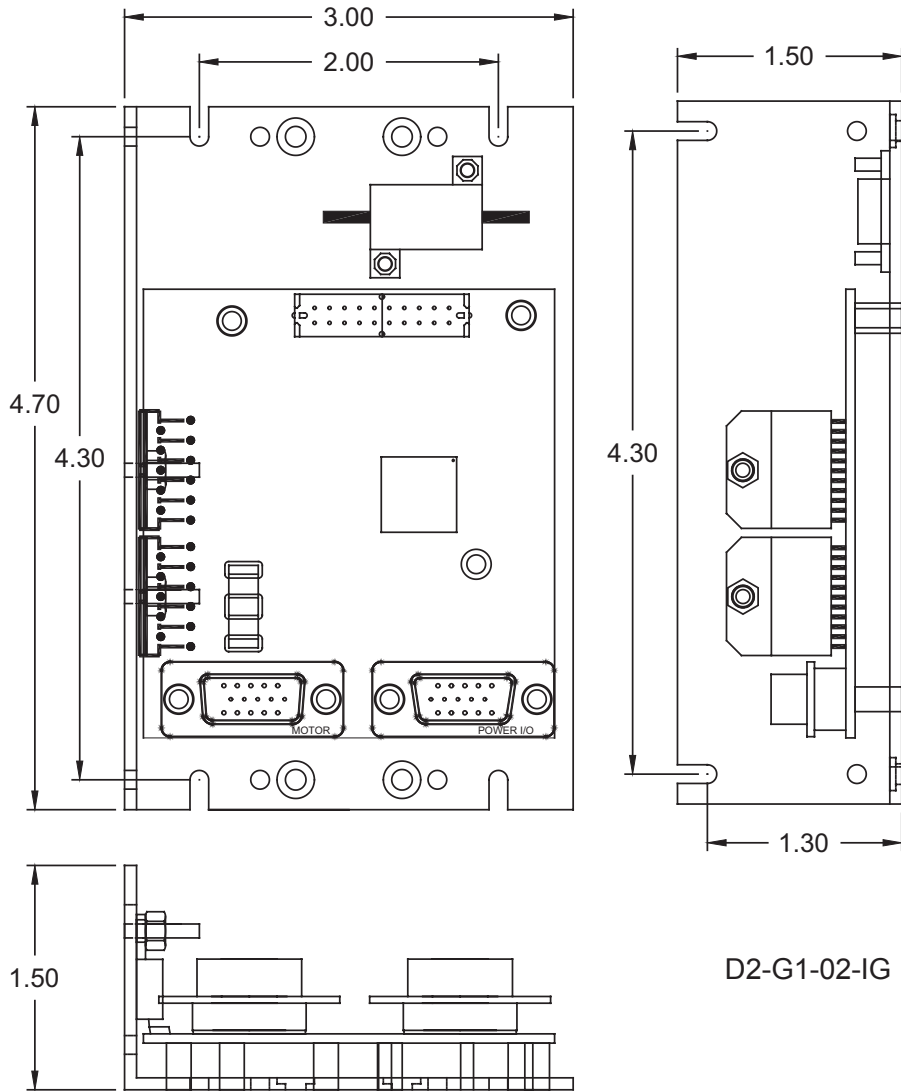

D2-G1-02-IG

* See -01-IG option for pinout information.

For detailed specifications see www.quicksilvercontrols.com

Controller/Driver

D2-G1-02-IG

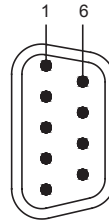
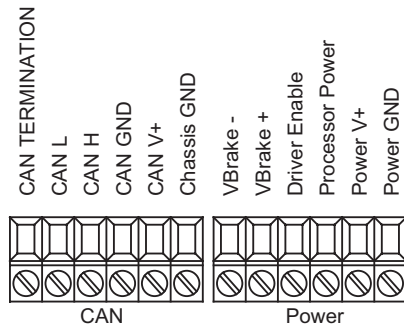

1	CAN L
2	RS-485 A / RS-232 TX
3	RS-485 B / RS-232 RX
4	N/A
5	LOGIC GROUND
6	CAN V+
7	N/A
8	CAN GND
9	CAN H

Motor

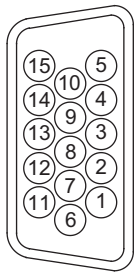

1	Motor B+
2	Chassis Ground
3	+5V Encoder Power
4	Encoder A -
5	Encoder B -
6	Motor A +
7	Motor B -
8	Encoder Z +
9	Encoder A +
10	Encoder Z -
11	Motor A -
12	Chassis Ground
13	Encoder B+
14	Encoder Ground
15	Motor Memory Access

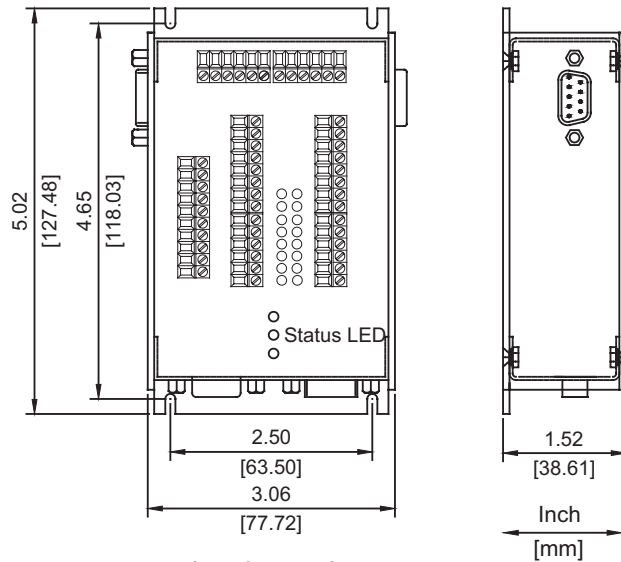

SilverLode Multi-Function Interface (SMI)

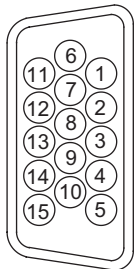

1	V+ (12-48 VDC)
2	RS-485B/RS-232 TX
3	+5V OUTPUT 100mA
4	I/O #3
5	I/O #6
6	POWER GROUND
7	V+ (12-48 VDC)
8	LOGIC GROUND
9	I/O #2
10	I/O #5
11	POWER GROUND
12	RS-485A/RS-232 RX
13	I/O #1
14	I/O #4
15	I/O #7

Fully Isolated I/O

Encoder In/Out & Comm

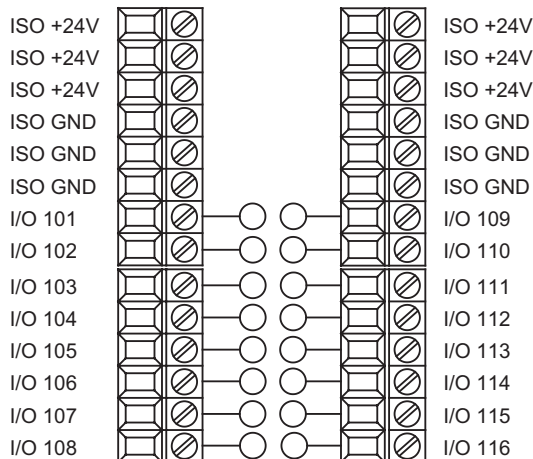
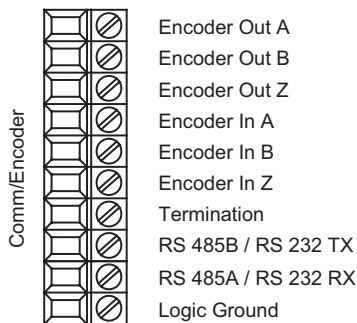

SilverDust MG

The SilverDust M-Grade (MG) is a compact motion controller/driver for servoing microstep NEMA 17 and 23 motors. The MG is designed to work with most microstep motors and encoders. QCI recommends at least a 1000 line encoder. Call QCI for supported motors.

QCI offers a simple Y cable to adapt the MG to our I-Grade motor/encoders.

For more detail, download the datasheet from our website: QCI-DS004 SilverDust MG.

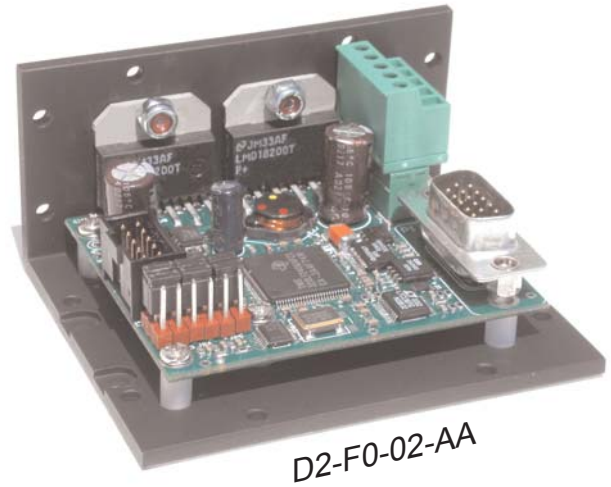

SilverDust Controller / Driver			
Driver	Controller	Options	Connectors
<p>D2 - 3.5 Amp</p> <ul style="list-style-type: none"> • For 23 Frame and Smaller • 3.5 Amps per Phase Continuous* • 4.5 Amp Peak <p>* Depending on heat sink (25C ambient).</p>	<p>F0 - Includes</p> <ul style="list-style-type: none"> • RS-232 or RS-485 • 7 Inputs or Outputs • 4 Inputs Double as Analog Inputs, 0-3.3V • 32KB Non-volatile Memory 	<p>01 – Board Only</p> <ul style="list-style-type: none"> • Requires user to properly heat sink. <p>02 – With L-Bracket for heat sinking.</p> <ul style="list-style-type: none"> • DIN compatible 	<p>AA –</p> <ul style="list-style-type: none"> • Motor: Plugged terminal strip (see datasheet). • Encoder: 10 Pin/Double Row (see datasheet). • Mating Connectors Sold Separately. • DB15: SilverLode Multi-Function I/F (SMI)
<p>To create a part number, choose one from each column above.</p> <p>For example:</p>			
D2	F0	02	AA
<p>This selection creates the part number: D2-F0-02-AA (Pictured)</p>			

Controller / Driver Specifications

Power

- Voltage Input (12-48 VDC)
- Current Input: (4.5 Amps Max)

Communications

- RS-232/485 Single or Multi-drop
- Baud Rates: 2.4Kbps - 230Kbps (Software Configurable)

I/O

- 7 @ 3.3Volts I/O Lines
- 4 Analog inputs (shared)

Driver/Amplifier

- 3.5 Amps/Phase Continuous
- 4.5 Amps/ Phase Peak

Unique Capabilities

- Compact Design
- 1023 Words Program Buffer (RAM)
- Extended User Registers (10-199)

Mechanical Specifications

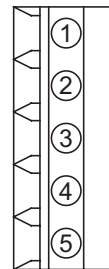
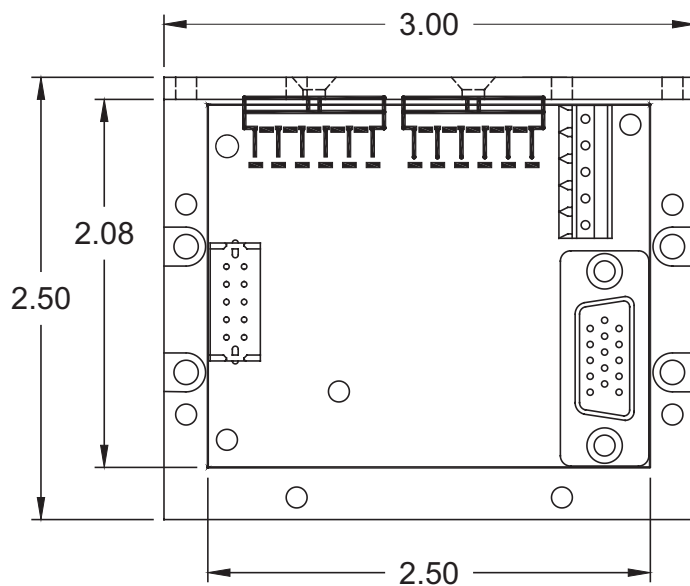

1	Motor B+
2	Motor B-
3	Motor A+
4	Motor A-
5	Ground

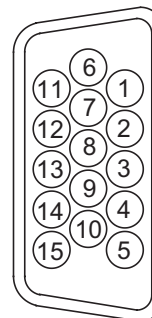

1	V+ (12-48 VDC)
2	RS-485B/RS-232 TX
3	+5V OUTPUT 100mA
4	I/O #3
5	I/O #6
6	POWER GROUND
7	V+ (12-48 VDC)
8	LOGIC GROUND
9	I/O #2
10	I/O #5
11	POWER GROUND
12	RS-485A/RS-232 RX
13	I/O #1
14	I/O #4
15	I/O #7

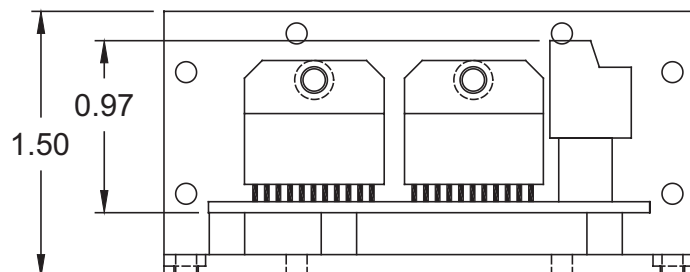

1	Logic Ground
2	Logic Ground
3	Encoder Z-
4	Encoder Z+
5	Encoder A-
6	Encoder A+
7	+5V
8	+5V
9	Encoder B-
10	Encoder B+

SilverNugget

SilverNugget I-Grade controller/drivers and the I-Grade motor/encoders use standard D-SUB connectors, which allows for inexpensive and reliable cables. The system is ideal for dusty environments and meets IP50 standards.

For more detail, download the datasheets from our website: QCI-DS005 SilverNugget N2 I-Grade and QCI-DS006 SilverNugget N3 I-Grade.



N2-E3-04-EE



N3-E3-04-EE

SilverNugget Controller / Driver							
Driver	Controller	Options	Motor Interface				
<p>N2 - 3.5 Amp</p> <ul style="list-style-type: none"> • For 23 Frame and Smaller • 3.5 Amps per Phase Continuous* • 4.5 Amp Peak 	<p>E3 – Standard</p> <ul style="list-style-type: none"> • 7 inputs or outputs (4 lines double as analog inputs, 0 to +5 VDC) • RS-232 or RS-485 • 32 Kilobyte memory <p>E7 – Driver Enable (no additional cost)</p> <p>M3 & M7 - Same as E3 with Modbus® Protocol.</p> <p>F2 - Same as E3 except incoming encoder / 2 to emulate 4000 CPR motor. See datasheet.</p>	<p>04 – I-Grade</p> <ul style="list-style-type: none"> • For Use with I-Grade motor/encoders • DB15: SilverLode Multi-Function I/F (SMI) 	<p>EE - I-Grade</p> <ul style="list-style-type: none"> • DB15 I-Grade Motor Interface 				
<p>N3 - 3.5 Amp</p> <ul style="list-style-type: none"> • For 34 Frame • 10 Amps per Phase Continuous* • 20 Amp Peak 	<p>E3 – Standard</p> <p>M3 – Modbus®</p> <p>F4 – Same as E3 except incoming encoder is divided by 4 to emulate a 4000 CPR encoder</p>	<p>04 – I-Grade</p> <ul style="list-style-type: none"> • For Use with I-Grade motor/encoders • DB15: SilverLode Multi-Function I/F (SMI) • DB-3 (Drive Power) 	<p>EE - I-Grade</p> <ul style="list-style-type: none"> • DB15 I-Grade Motor Interface (Used for Encoder) • DB-5 (Motor Pwr) <p>(See Datasheet)</p>				
<p>To create a part number, choose one from each column above.</p> <p>For example:</p> <table border="1" style="width: 100%; text-align: center;"> <tr> <td>N2</td> <td>E3</td> <td>04</td> <td>EE</td> </tr> </table> <p>This selection creates the part number: N2-E3-04-EE</p>				N2	E3	04	EE
N2	E3	04	EE				

SilverNugget N2

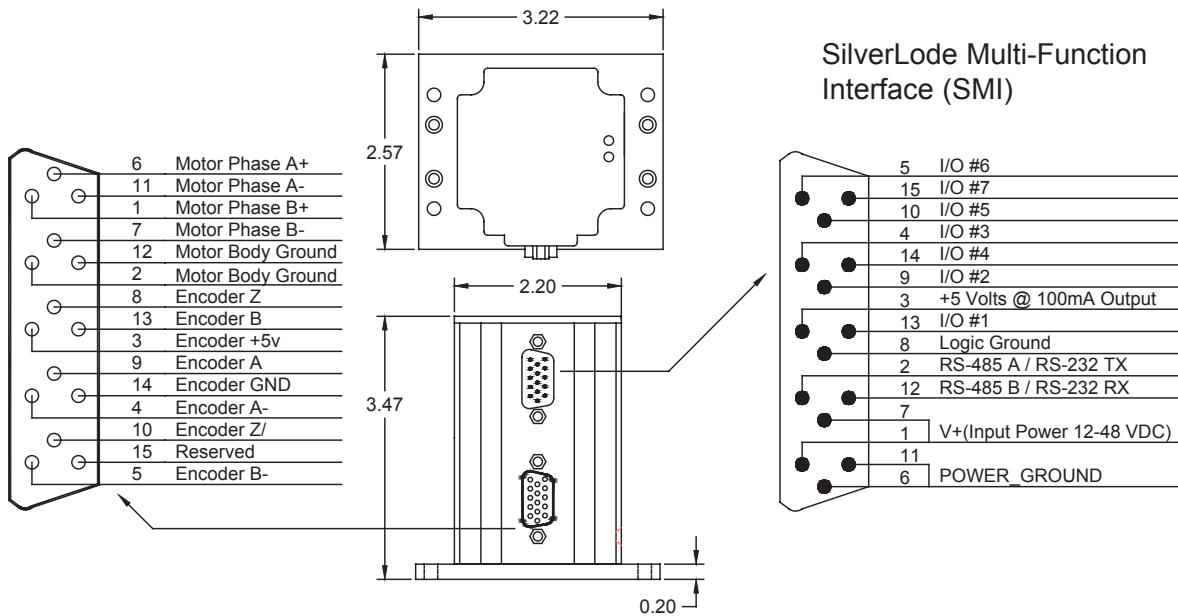

SilverNugget N3

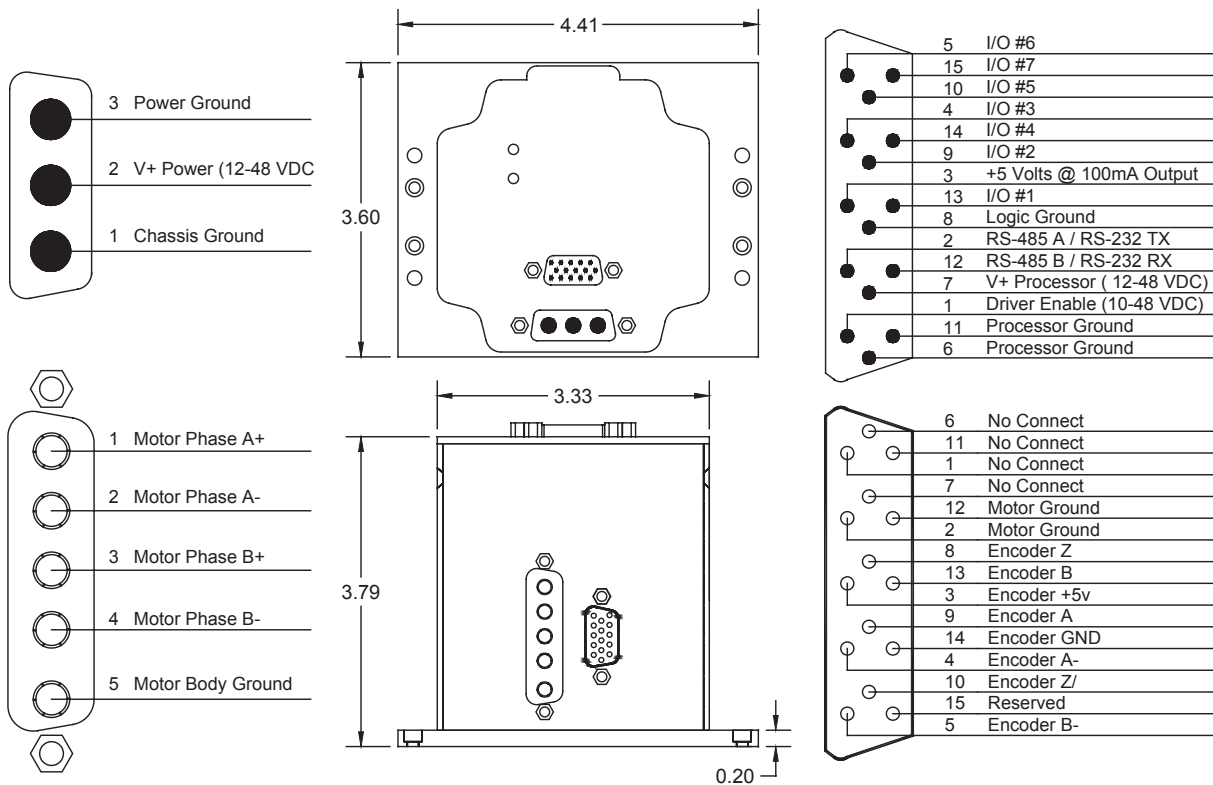

All Dimensions are in inches unless otherwise specified.

For detailed specifications see www.quicksilvercontrols.com

NEMA 17 I-Grade Motor/Encoder

In recent years the motion control industry has moved from larger size motors to smaller more compact motors. To meet the market needs, Quicksilver Controls has developed the NEMA 17 Frame I-Grade motors. The I-Grade motors have unique encoder design, memory unit, and special line terminations for superior speed-torque control when used with SilverLode controller/drivers.



For more detail, download the datasheet from our website:
QCI-DS007 NEMA 17 I-Grade Motor/Encoder.

Specifications	17-1	17-3	17H-1	17H-3
Maximum Speed (RPM)	2500	2500	4000	4000
Torque at Optimal Speed (oz-in)	12	19	16	30
Continuous Stall Torque (oz-in)	21	36	23	43
Peak Power (Mech. Watts)	16	24	34	69
Rotor Inertia (oz-in ²)	0.19	0.37	0.19	0.37
Weight (ounces)	9.5	14.3	9.5	14.3
Maximum Current (amps)	1.3	1.5	3.0	4.0

NEMA 17 Frame Motor			
Motor Type	Motor Size	Encoder Option	Motor Option
17 - Standard 17H - High Power	<ul style="list-style-type: none"> • 1 • 3 	A - Standard 8000 CPR Encoder • See Datasheet	01 - Standard • DB-15 Connector 6T - IP65 • Round IP65 Connector (See 6T section)
To create a part number, choose one from each column above. For example:			
17H	3	A	01
This selection creates the part number: QCI-A17H-3-A-01			

Standard NEMA 17 Mechanical

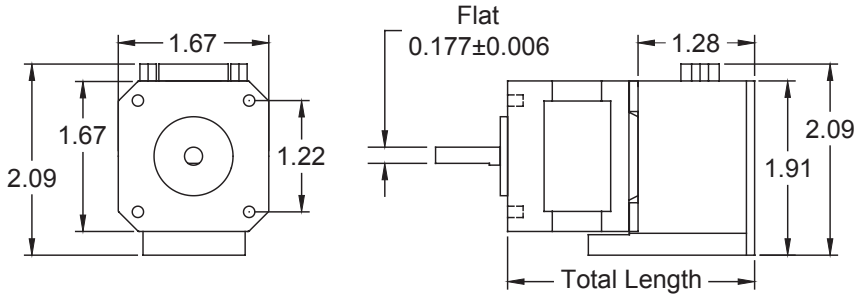

Motor Series	Total Length
17-1	2.58 " +/- 0.10
17H-1	2.58 " +/- 0.10
17-3	3.13 " +/- 0.10
17H-3	3.13 " +/- 0.10

See our website for individual CAD files.

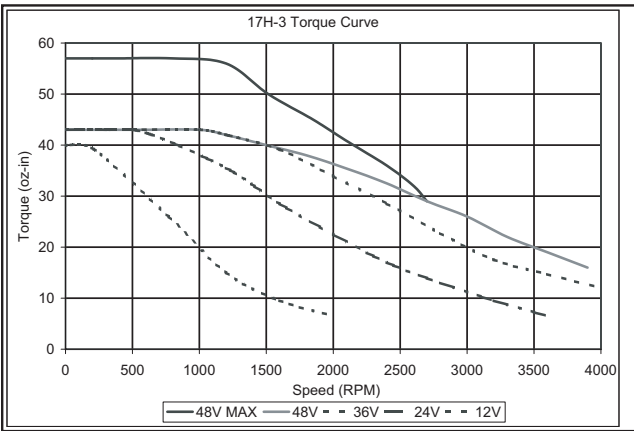
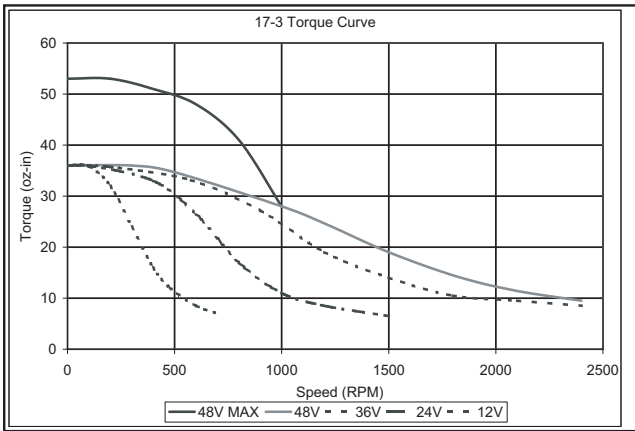
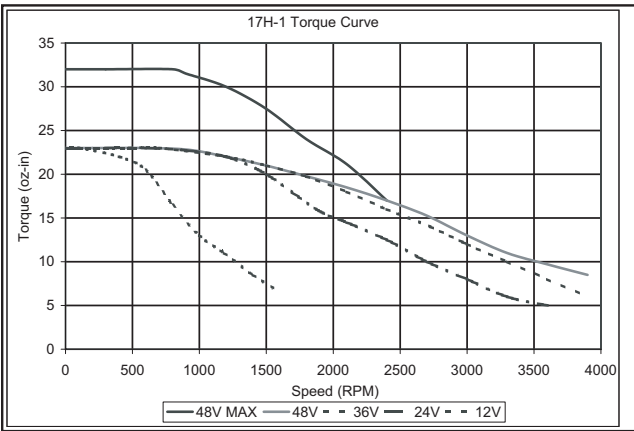
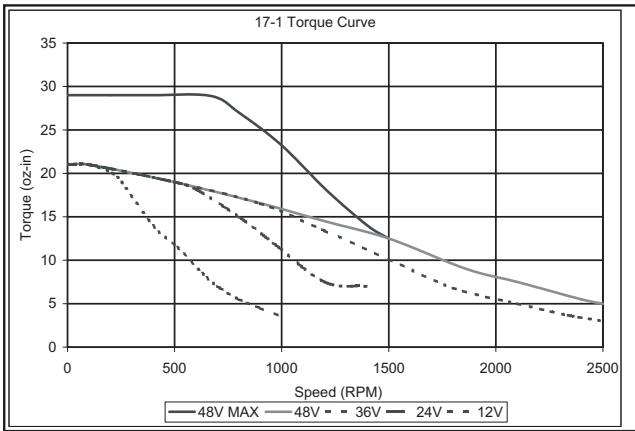

NEMA 23 I-Grade Motor/Encoder

The NEMA 23 frame motors are offered in both high power and low power versions. The low power version exhibits excellent torque at low speed. The high power version provides superior torque at broader speed ranges approaching 4000 RPM.

For more detail, download the datasheet from our website: QCI-DS008 NEMA 23 I-Grade Motor/Encoder.



Specifications	23T-7	23-3	23-5	23H-1	23H-3	23H-5
Maximum Speed (RPM)	1000	2000	2000	4000	4000	4000
Optimal Speed (RPM)	400	500	200	2500	1500	1000
Torque at Optimal Speed (oz-in)	220	110	225	31	43	120
Continuous Stall Torque (oz-in)	300	125	240	40	72	190
Peak Power (Mech. Watts)	117	47	47	78	60	95
Rotor Inertia (oz-in ²)	3.24	1.36	2.34	0.74	1.58	2.35
Weight (pounds)	3.2	1.70	2.50	1.36	1.85	2.7
Maximum Current (amps)	4.0	3.0	3.0	4.0	4.0	4.0

NEMA 23 Frame Motor			
Motor Type	Motor Size	Encoder Option	Motor Option
23 - Standard 23H - High Power	<ul style="list-style-type: none"> • 1 • 3 • 5 	A - Standard 8000 CPR Encoder • See Datasheet	01 - Standard • DB-15 Connector 6T - IP65 • Round IP65 Connector (See 6T section)
23T - High Torque	<ul style="list-style-type: none"> • 7 		
To create a part number, choose one from each column above. For example:			
23H	5	A	01
This selection creates the part number: QCI-A23H-5-A-01			

Standard NEMA 23 Mechanical

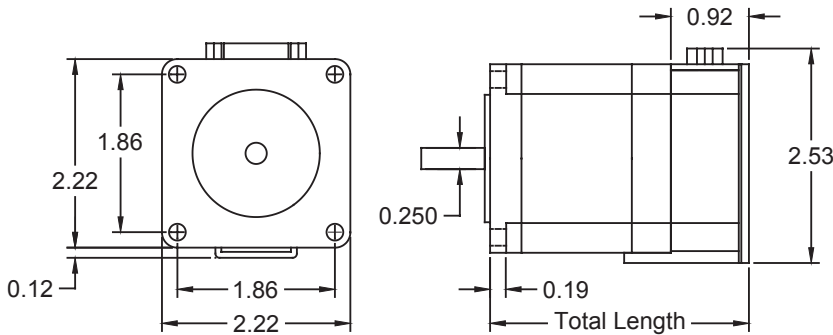

Motor Series	Total Length
23-3	3.05 " +/- 0.10
23-5	3.88 " +/- 0.10
23H-1	2.56 " +/- 0.10
23H-3	3.05 " +/- 0.10
23H-5	3.95 " +/- 0.10
23T-7	4.98 " +/- 0.10

23T-7 shaft is different. See Datasheet for more details.

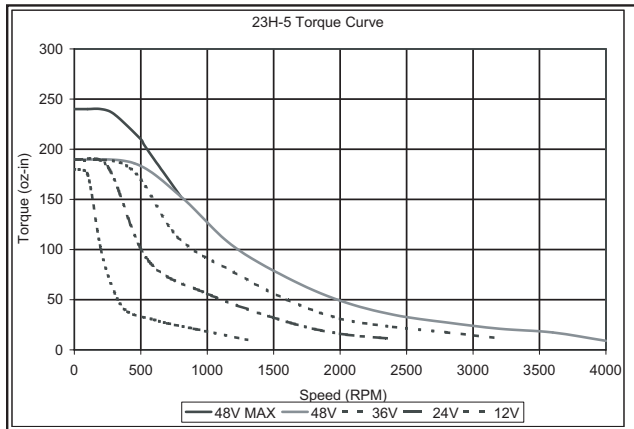
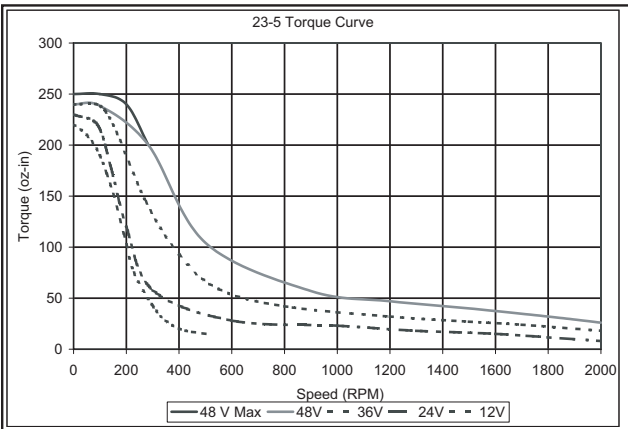
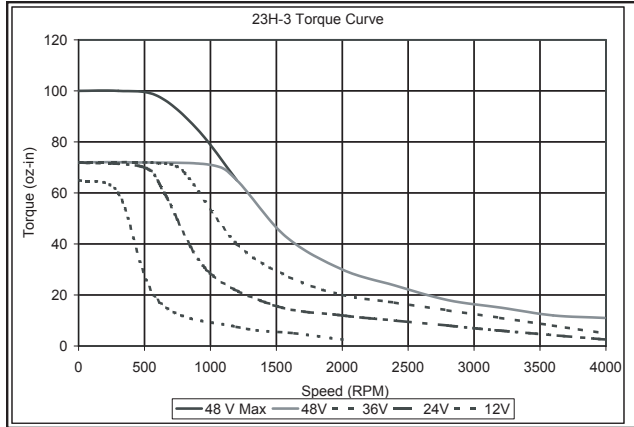
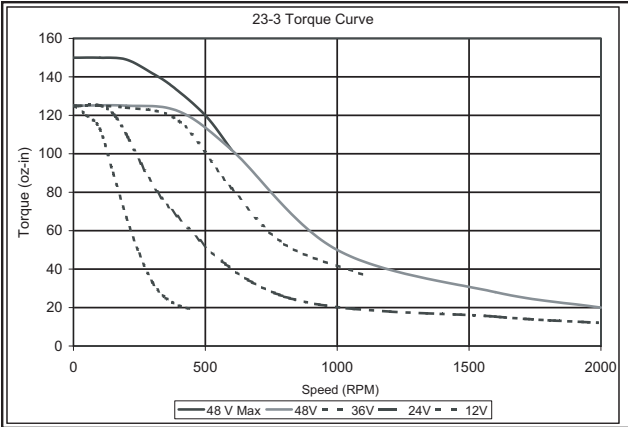
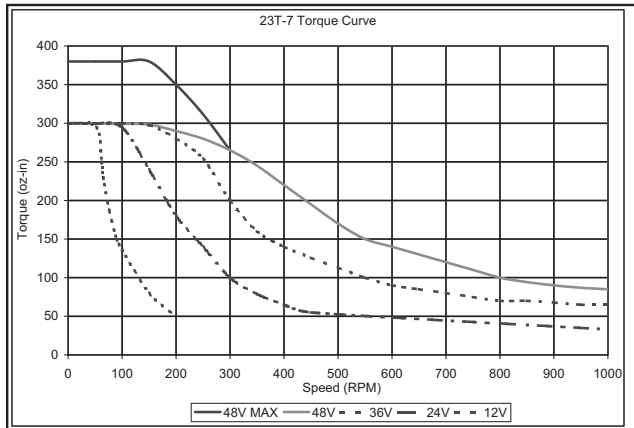
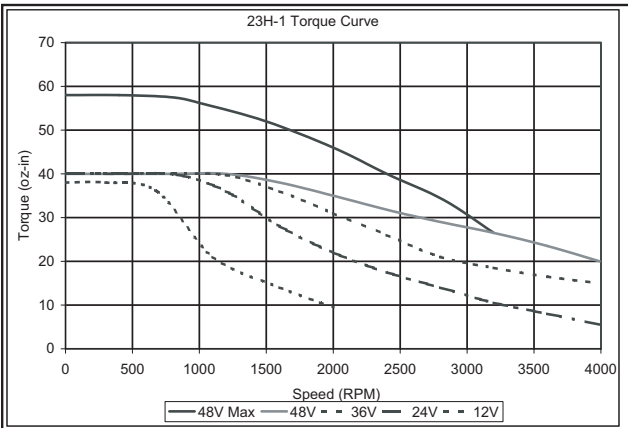

NEMA 17 & 23 IP65 Motor/Encoder

QuickSilver Controls fills the industry need for wash down servo systems with our new line of NEMA 17 & 23 IP65 motor/encoders. Based on QuickSilver's existing 17 & 23 frame motors, this new line exceeds the IP65 standard. Both the motor and encoder signals route through the single round connector.

For more detail, download the datasheets from our website: QCI-DS002 NEMA 17 IP65 Motor/Encoder and QCI-DS001 NEMA 23 IP65 Motor/Encoder



IP65 NEMA 17 Mechanical

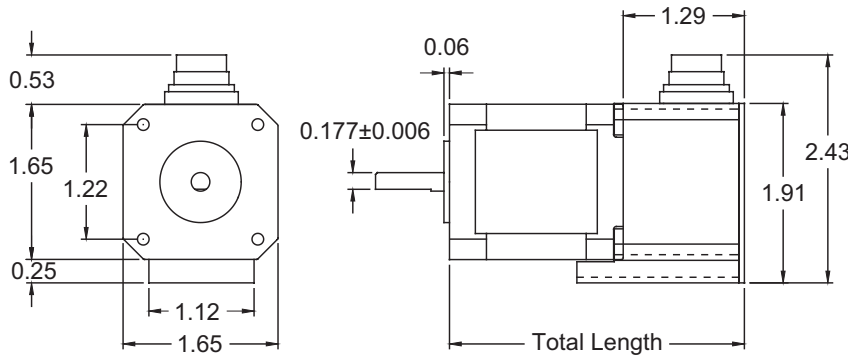

Motor Series	Total Length
17-1	2.59 " +/- 0.10
17H-1	2.59 " +/- 0.10
17-3	3.14 " +/- 0.10
17H-3	3.14 " +/- 0.10

IP65 NEMA 23 Mechanical

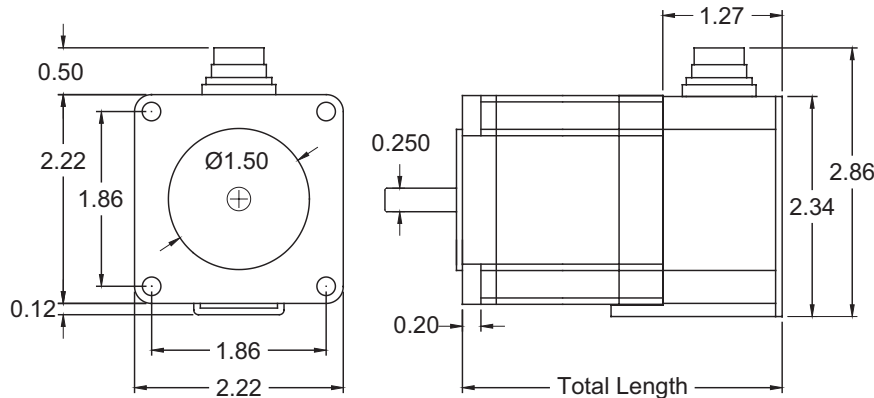

Motor Series	Total Length
23-3	3.40 " +/- 0.10
23-5	4.23 " +/- 0.10
23H-1	2.91 " +/- 0.10
23H-3	3.40 " +/- 0.10
23H-5	4.30 " +/- 0.10

Note: IP65 are motors not meant for continuous wet operation. These motors are meant for periodic water wash down applications. See IP65 specification for more detail (CEI IEC 529). Operating the motors outside IP65 specifications may produce undesirable results and will void factory warranty.

IP 65 “6T”



Shaft Seals (QCI-17M-65) (QCI-23M-65)

The shaft seal (sold separately) is required for an IP65 rating on the shaft end of the motor. The shaft seal consists of an o-ring seal for the motor’s pilot and a quad ring seal for the shaft. The shaft seal needs periodical inspections, lubrication, and replacement if worn.

SilverNugget N2 Controller/Driver (N2-E3-04-EE) or SilverDust D2 IG/IGB Controller/Drivers (i.e. D2-G1-02-IG, D2-G1-03-IGB)

These motors will work with any of the above controller/drivers. See the SilverNugget I-Grade N2 and SilverDust D2 IG/IGB datasheets for more details.

Motor Interface Cable (QCI-C-D15P-T14S-nn)

This cable goes between the motor and the QuickSilver Controller/Driver (SilverDust or SilverNugget). Replace the last two digits “nn” with length of cable in feet (i.e. –10 for 10 feet).

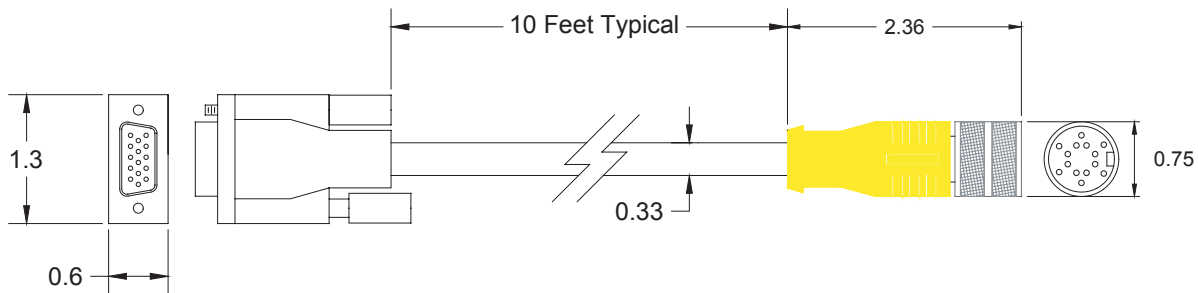

Quicksilver Controls, Inc.

NEMA 34 I-Grade Motor/Encoder

All NEMA 34 frame motors come with 16000 CPR encoder for position accuracy. With torque ranges from 550 oz-in to 3200 oz-in, our line of 34 frame motors cover most applications with speed ranges up to 2000 RPM.

For more detail, download the datasheet from our website: QCI-DS009 NEMA 34 I-Grade Motor/Encoder.



Motor Specifications	34N-1	34H-1	34HC-1	34HC-2	34HC-3	34HC-4
Maximum Speed (RPM)	2000	2000	3000	2500	2000	1500
Optimal Speed (RPM)	800	800	1600	1600	1000	800
Torque at Optimal Speed (oz-in)	275	390	350	390	770	990
Continuous Stall Torque (oz-in)	460	500	675	1300	1950	2550
Peak Power (Mech. Watts)	170	260	440	565	580	515
Rotor Inertia (oz-in ²)	7.8	7.8	7.8	14.7	21.9	29.0
Weight (pounds)	5.73	5.73	5.7	9.1	12.6	15.8
Maximum Current (amps)	8.0	8.0	13.5	16.5	16	14.5

NEMA 34 Frame Motor			
Motor Type	Motor Size	Encoder Option	Motor Option
34N 34H	• 1	B - Standard 16000 CPR Encoder • See Datasheet	01 - Standard • DB-15 Connector • DB-5 Connector
34HC	• 1 • 2 • 3 • 4		
To create a part number, choose one from each column above. For example:			
34HC	1	B	01
This selection creates the part number: QCI-A34HC-1-B-01			

Standard NEMA 34 Mechanical

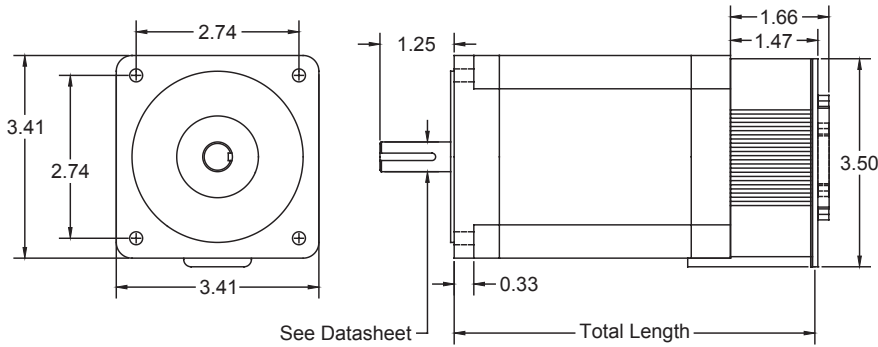

Model Series	Total Length
34N-1	4.54 " +/- 0.10
34H-1	4.54 " +/- 0.10
34HC-1	4.54 " +/- 0.10
34HC-2	6.12 " +/- 0.10
34HC-3	7.60 " +/- 0.10
34HC-4	9.15 " +/- 0.10

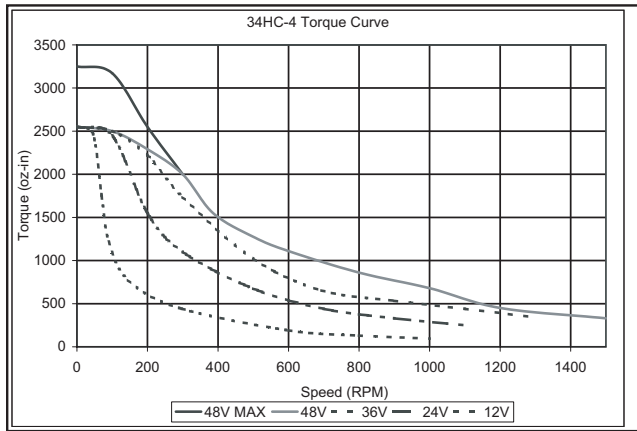
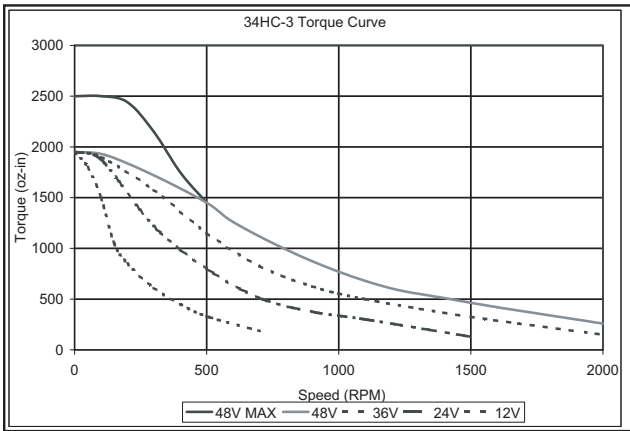
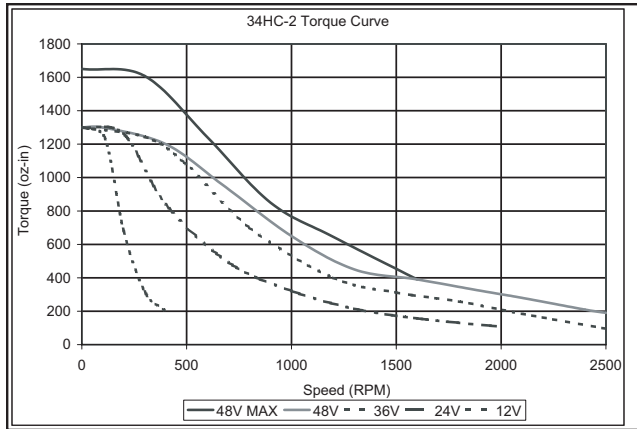
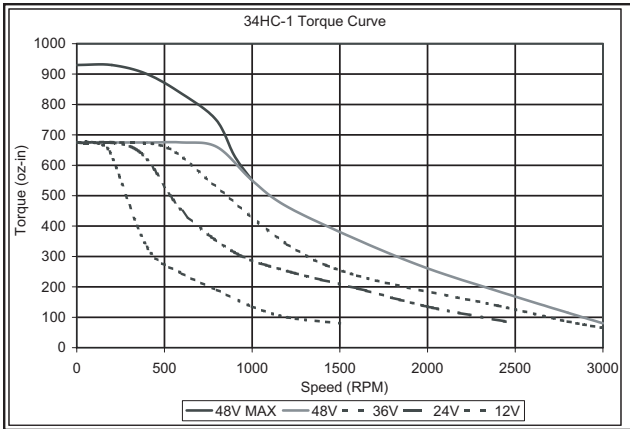
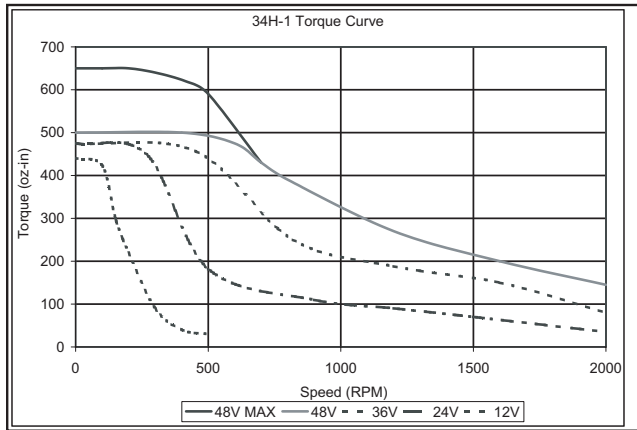
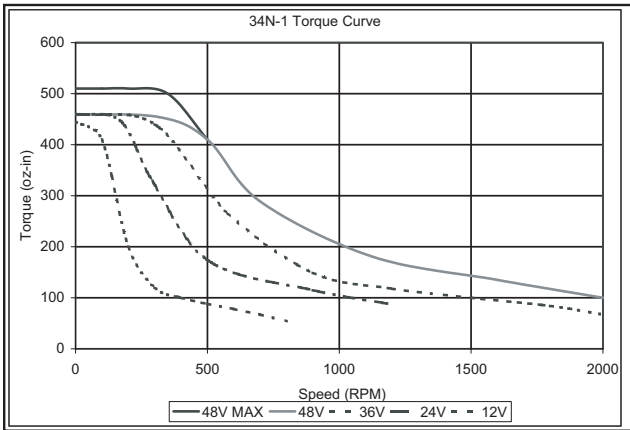

Cables

QCI-EC-SMI-nn (nn = Length)

SilverLode Multi-Function Interface (SMI) Cable. This DB15HD to DB15HD cable connects from the SilverLode Controller/Driver SMI connector to one of our breakouts with a SMI connector.

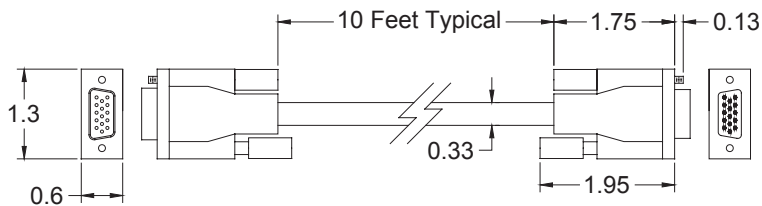

QCI-C-D15P-D15S-nn (nn = Length)

Motor Interface Cable. Socket end goes into any I-Grade motor. Plug end connects to any I-Grade controller/driver. Motor interface cable is designed to minimize incoming and outgoing noise. Contact QCI technical support if you plan to make your own cable.

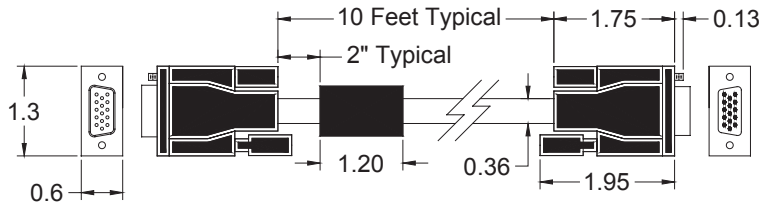

QCI-34EC-LP-nn (nn = Length)

Line Power Cable. Required to power the SilverNugget N3.

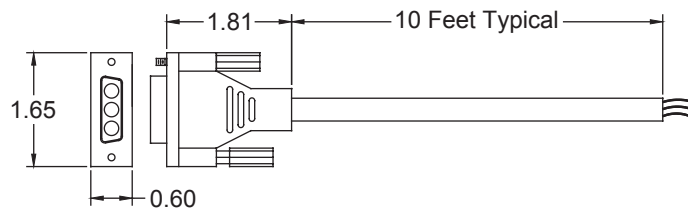

QCI-C-D5P-D5S-nn (nn = Length)

DB5 Motor Interface Cable. Due to high power consumption up to 25 Amps, the NEMA 34 motors require this separate power cable and QCI-D15P-D15S-nn (nn = length) for a complete system.

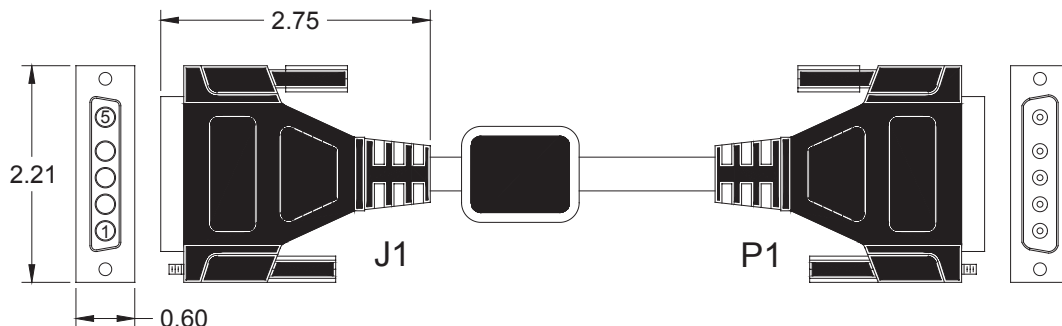

Accessories

RS-232 to RS-485 Interface Communication Module

Part Number: QCI-RS485

D25 Socket (PC) to terminal strip (RS485). Accepts the same power as controller (i.e. 12-48VDC). Converts Standard PC COM1 or COM2 to RS-485.

Note: Controller is able to use RS-232 or RS-485 without any additional hardware.



QCI-D15HD-FIL-4

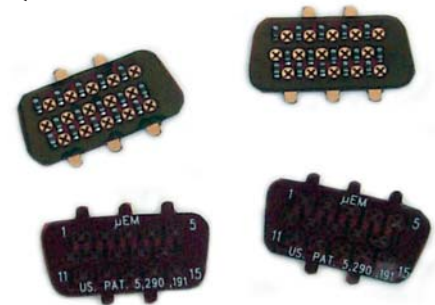

High Density 15 Pin D Connector Filters

Part Number: QCI-D15HD-FIL-4

470 pF in line "T" filters. They reduce emitted EMI/RFI as well as reducing susceptibility to EMI and ESD by shunting high frequency energy directly to the housing. The in-conductor design minimizes series inductance to provide wide band filtering. Package of four.

Cable Inductors

Part Number: QCI-CI4-4

Snap on ferrite filter forms a series impedance for all conductors entering the motor. This common mode series impedance helps to balance currents flowing in the conductors while not affecting the differential mode signals (such as RS-485 and power). Particularly useful to reduce ground noise susceptibility and emissions. Package of four.



NOTE: Combine Cable Inductors and Filters.

The combination forms an "L" filter having even greater attenuation of emitted EMI/RFI and of susceptibility to EMI and ESD. The combination may be useful in environments with very high ESD or strong RF fields.

Optical I/O Modules

In complex systems where there are multiple power sources and I/O interfaces, Quicksilver's optical I/O module is the best solution to keep I/O ground local for signal integrity and avoid ground loop issues.

The SilverNugget and SilverDust MG & IG are only capable of supplying TTL level signal I/Os. In some industrial applications 24 Volts I/Os are required. Quicksilver's 24 Volts optical I/O module will convert TTL level signals to 24 I/O signals and is capable of sinking up to 1A of current per channel to drive solenoid and relays.

These modules are meant for ground loop isolation and driving large loads up to 1 Amp. Applications that do not meet these two conditions should look at the Breakout Module section. Breakout modules are less expensive and will reduce complexity for systems that do not need the extra ground loop isolation and 24 Volts I/O usage.

QCI-OPTMC-24

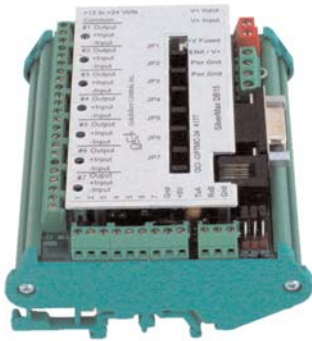

Features

- SilverLode Multi-Function I/F (SMI) Connector
- 7 I/O for use as: Open Collector, TTL, Input or Output usage
- Each line is connected to an LED to indicate state of I/O line.
- Serial comm is connected by terminal strip or RJ-11 plug
- Small size (approx 4.0" x 3.0") designed to fit DIN rail systems.
- Ground isolation for clean noise-free TTL encoder input.
- 1 Amp sinking per Output
- All Optical input lines are diode protected.
- Isolated I/O and Main Power supply connections are fused.
- DIN Mountable

Part Numbers:

QCI-OPTM-5 PCB only! Intended for use with 5V level I/O and encoders.

QCI-OPTMC-5 PCB mounted on DIN Rail Carrier. Intended for use with 5V level I/O and encoders.

QCI-OPTM-24 PCB only! Intended for use with common industrial 24V I/O.

QCI-OPTMC-24 PCB mounted on DIN Rail Carrier (pictured). Intended for use with 24V I/O.



Two Channel Optical Input Module with DIN Carrier

For those cases where only two inputs are needed, the OPTO2 is priced to meet the need. This DIN mounted package is small and optically isolates two inputs into the device. Two versions are offered:

Part Numbers:

QCI-OPTO2-24 (pictured) Two Channel Optical Input Module with DIN Carrier. 5-48 VDC input. 5V TTL Output. Max 10KHz.

QCI-OPTO2-5 Two Channel Optical Input Module with DIN Carrier. 5V input. 5V TTL Output. Max 500KHz.

Breakouts

Network and Training Breakouts - QCI-BO-N, QCI-BO-T

These modules breakout the SilverLode Multi-Function Interface (SMI) connector to power, communication, and I/Os terminals for wiring. The Training Breakout provides switches, a potentiometer, and a push button for new users to easily evaluate the system. The Network Breakout is meant for networking multiple units together on a DIN rail.



Features

- SilverLode Multi-Function I/F (SMI) Connector
- 2 D9 connectors provided for connection to a standard PC serial port (i.e. COM1 or COM2)
- Terminals For all I/O
- Terminals For Power
- Multiple Terminals for Extra +5V and Signal Ground
- Cascade Multiple Units on DIN Rail to Create a Network
- Power Switch and LED
- Soft Power up to Reduce Turn On Surge Current
- RS-485 Termination Jumpers
- DIN Mountable

Basic Breakout - QCI-BO-B

This breakout mounts directly onto the SilverNugget N2 or SilverDust MG & IG. The Basic Breakout is the least expensive way to breakout a SilverLode Multi-Function Interface (SMI) connector. No optical isolation makes it less expensive than the Optical I/O Module (QCI-OPTMC-24). Great for networking two or more servos.

Features:

- SilverLode Multi-Function I/F (SMI) Connector
- Mount directly onto SilverNugget, SilverDust MG and IG
- Daisy chain for input Power, Ground, and communications for two or more servo systems.
- D9 connector provided for connection to a standard PC serial port (i.e. COM1 or COM2).
- Terminals for all I/O
- Terminals for Power
- DIN Mountable

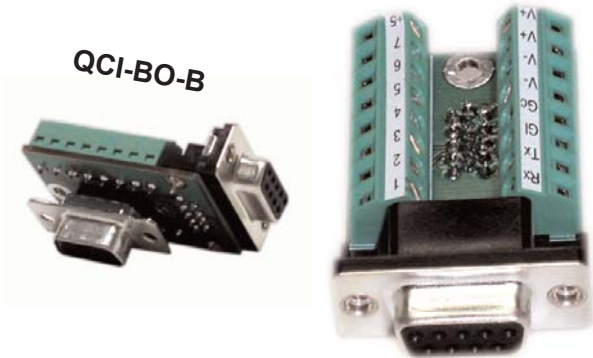

Clamp Modules

When the motor provides braking torque to a load, it is actually acting as a generator. The regenerated power flows back into the power supply rail. If this regenerated power exceeds the balance of the other power drawn in the system the excess power must be stored in the capacitors present, causing the power supply voltage to rise. Excessive power supply voltage may damage components in either the power supply or the controller/drivers or other loads connected to the power supply. The Clamp module provides a means of redirecting this excess generated power into one or more power resistors, protecting the system.

The Clamp Module also has the ability to accept and isolate two power supplies that power the device. A "low voltage" secondary power supply input is useful when a requirement exists to maintain encoder and controller functionality during main power disconnect.

NOTE: A Clamp module is required for all 34-Frame applications, and is recommended for 17/23 applications where braking, aggressive deceleration, or high inertial loads are present. The SilverDust IG and IGB have the clamp circuit built in, and thus do not need an external Clamp module.

NOTE: Contact QCI's application support for assistance regarding the use of the clamp module if necessary.

Clamp - Regenerative Power Protection

During regenerative deceleration, the clamp circuit will automatically engage within microseconds, maintaining the DC bus voltage no more than 1.5 Volts greater than incoming voltage. One or more clamp resistors are used to dissipate excess energy and maintain a safe DC bus voltage.

Closed Frame Clamp Module - QCI-CLCF-04-R4

- 12A Max
- DIN Mountable
- Additional resistors may be purchased for 20 Amps Max. See our clamp module technical document for more details.

Clamp - Intelligent Shutdown

Applications requiring disconnect of main power may also require controller and encoder to remain active. Clamp modules provide for secondary input of a 2.5W - 9VDC power supply that will maintain servo intelligence. (2.5 W required per device)

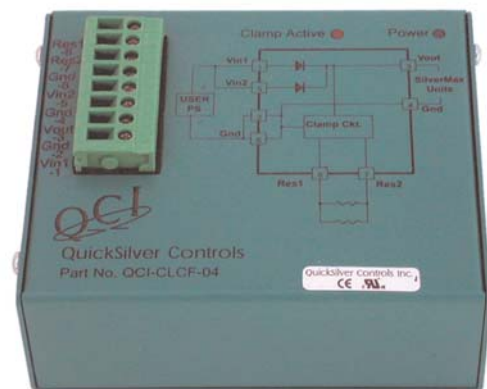

Clamp Modules

High Current Version Without Internal Resistor - QCI-CLCF-04

- 20A Max
- Requires external resistors such as the QCI-CLRP-2
- DIN Mountable



QCI-CLCF-04



QCI-CLOF-04

High Current Open Frame Clamp Module - QCI-CLOF-04

- 20A Max.
- Requires external resistors such as the - QCI-CLRP-2
- DIN mountable

Clamp Module Resistor Pack QCI-CLRP-2

- 2 Ohm
- Heat Sink
- DIN mountable
- 2 °C rise/watt dissipated
- 18" Flying Leads



QCI-CLRP-2

Other Resources



For all the latest information from QuickSilver Controls check out our website

www.QuickSilverControls.com

There you will find:

- New products
- Software updates
- Brochures
- Manual revisions
- Application notes and white papers
- Distributor contacts

TECHNICAL SUPPORT

Email: support@QuickSilverControls.com

Please have the following information ready:

- 1) QCI part number(s) and serial number(s)**
- 2) Distributor name and date of purchase**
- 3) Product configuration: host type, communications, voltage, etc.**
- 4) Application information: motion profile, load inertia, etc.**
- 5) Any technical details applicable to the support inquiry.
(specific behavior, physical problems, etc.)**

QuickSilver Control's tech support is available from 8AM to 4PM Pacific Standard Time. Our Engineering team can answer questions regarding the application, set-up, and operation of QuickSilver's products.

Extended Customer Support and Applications Development are available on a contract basis. Contact QCI for full details.

Units Conversion

Inertia - To convert from A to B, multiply by constant

A \ B	oz-in ²	oz-in-s ²	lb-in ²	lb-in-s ²	NMs ²	g-cm ²	kg-m ²	kgf-m-s ²
oz-in ²	1	2.59*10 ⁻³	6.25*10 ⁻²	1.6188*10 ⁻⁴	1.8289*10 ⁻⁵	182.9	1.8289*10 ⁻⁵	1.86*10 ⁻⁶
oz-in-s ²	386.09	1	24.131	6.25*10 ⁻²	7.0612*10 ⁻³	7.0612*10 ⁴	7.0612*10 ⁻³	7.2*10 ⁻⁴
lb-in ²	16	4.1441*10 ⁻²	1	2.5901*10 ⁻³	2.9262*10 ⁻⁴	2926.2	2.9262*10 ⁻⁴	2.9839*10 ⁻⁵
lb-in-s ²	6177	16	386.09	1	0.11298	1.1298*10 ⁶	0.11298	1.1521*10 ⁻²
NMs ²	5.4678*10 ⁴	141.62	3417.4	8.8512	1	1*10 ⁷	1	0.10197
g-cm ²	5.4678*10 ⁻³	1.4162*10 ⁻⁵	3.4174*10 ⁻⁴	8.8512*10 ⁻⁷	1*10 ⁻⁷	1	1*10 ⁻⁷	1.0197*10 ⁻⁸
kg-m ²	5.4678*10 ⁴	141.62	3417.4	8.8512	1	1*10 ⁷	1	0.10197
kgf-m-s ²	5.3621*10 ⁵	1388.8	3.3513*10 ⁴	86.801	9.8067	9.8067*10 ⁷	9.8067	1

Power - To convert from A to B, multiply by constant

A \ B	Watt	HP	Nm-RPS	in-oz-RPM	ft-lb-RPM	ft-lb/sec	Nm/sec
Watt	1	1.341*10 ⁻³	0.1592	1352	7.042	0.7375	1
HP	745.7	1	118.7	1.0083*10 ⁶	5251.4	549.93	745.7
Nm-RPS	6.283	8.426*10 ⁻³	1	8496	44.25	4.634	6.283
oz-in-RPM	7.396*10 ⁻⁴	9.918*10 ⁻⁷	1.177*10 ⁻⁴	1	5.208*10 ⁻³	5.454*10 ⁻⁴	7.396*10 ⁻⁴
ft-lb-RPM	0.142	1.904*10 ⁻⁴	2.26*10 ⁻²	192	1	0.1047	0.142
ft-lb/sec	1.356	1.818*10 ⁻³	0.2158	1833	9.549	1	1.356
Nm/sec	1	1.341*10 ⁻³	0.1592	1352	7.0423	0.7375	1

Torque - To convert from A to B, multiply by constant

A \ B	ft-lb	in-lb	in-oz	N-m	kgf-m	kgf-cm	gf-cm
ft-lb	1	12	192	1.3558	0.13825	13.825	1.3825*10 ⁴
in-lb	8.333*10 ⁻²	1	16	0.113	1.1521*10 ⁻²	1.1521	1152.1
oz-in	5.2083*10 ⁻³	6.25*10 ⁻²	1	7.0615*10 ⁻³	7.2006*10 ⁻⁴	7.2006*10 ⁻²	72.006
N-m	0.73757	8.8509	141.61	1	0.10197	10.197	1.0197*10 ⁴
kgf-m	7.2331	86.798	1388.8	9.8067	1	100	1*10 ⁵
kgf-cm	7.2331*10 ⁻²	0.86798	13.888	9.8067*10 ⁻²	1*10 ⁻²	1	1000
gf-cm	7.2331*10 ⁻⁵	8.6798*10 ⁻⁴	1.3888*10 ⁻²	9.8067*10 ⁻⁵	1*10 ⁻⁵	1*10 ⁻³	1

Warnings



Warnings: Quicksilver Controls' products shall not be used for Life Support applications without the explicit written permission from the President of Quicksilver Controls, Inc. SilverLode products are high performance motion systems. As with any motion system, it is capable of producing sufficient mechanical output to cause bodily injury and/or equipment damage if it is improperly operated or if it malfunctions. The user shall not attach the control system to any mechanism until its operation is fully understood. Furthermore, the user shall provide sufficient safety means and measures to protect any operator from misuse or malfunction of the motion system. The user assumes all liability for its use. Quicksilver disclaims any implied warranty of merchantability or of the fitness of the same for any purpose. Purchaser is solely responsible for determining the adequacy of the product for any and all uses to which the purchaser applies the product, and the application of the product by purchaser will not be subject to any implied warranty of fitness for that purpose. Under no circumstances shall Quicksilver be responsible for any incidental or consequential damages.