

DArk Matter Particle ExpLorer (DAMPE)

Li, Xiang

Purple Mountain Observatory, CAS
Nanjing, China

xiangli@pmo.ac.cn

xiangli.1988.cn@gmail.com

on behalf of DAMPE team

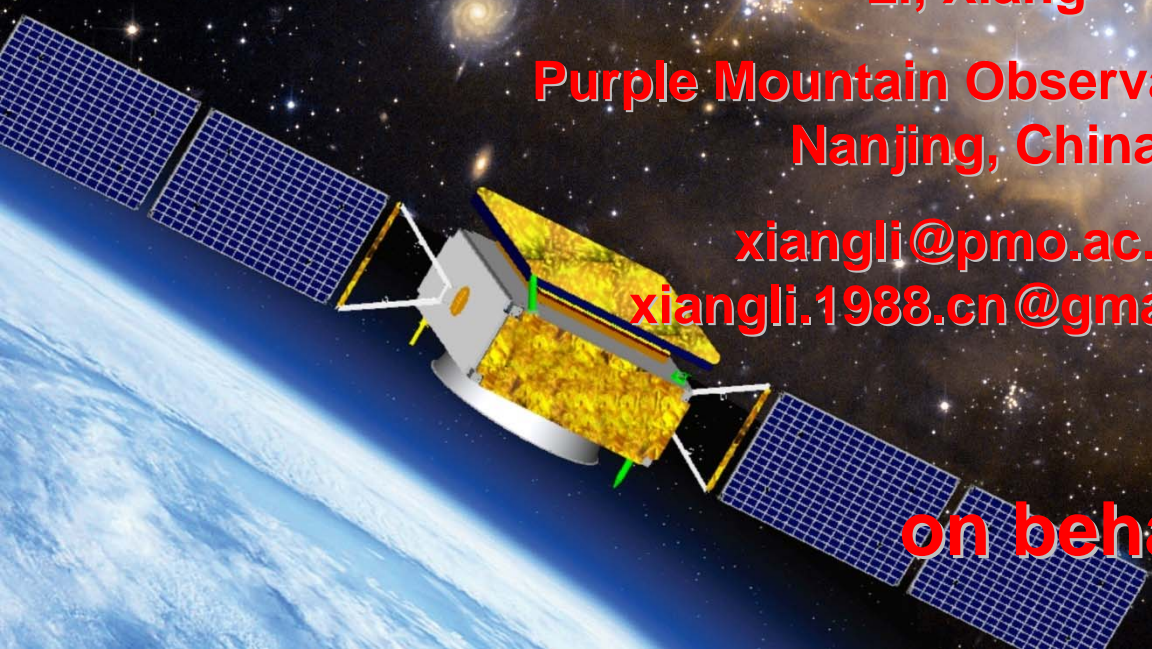



DM indirect detection

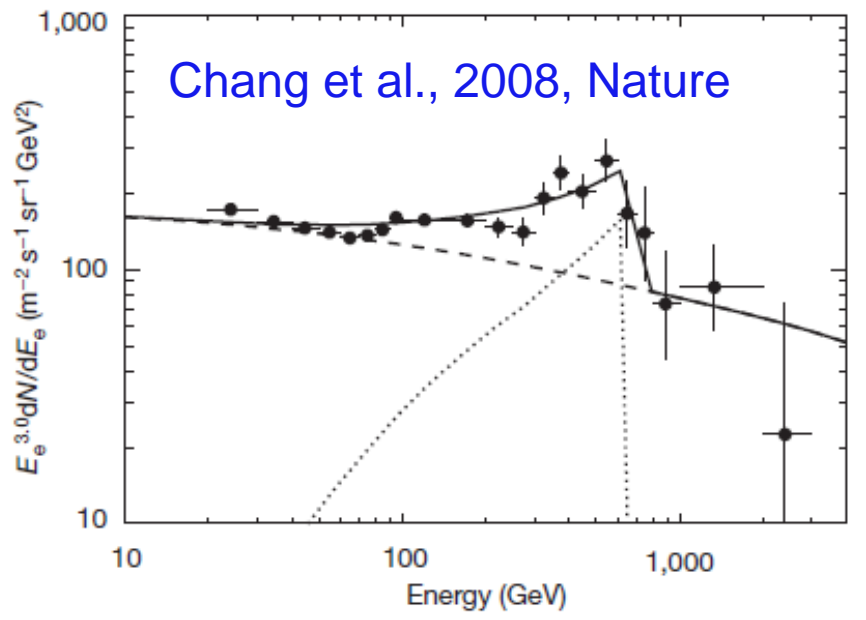
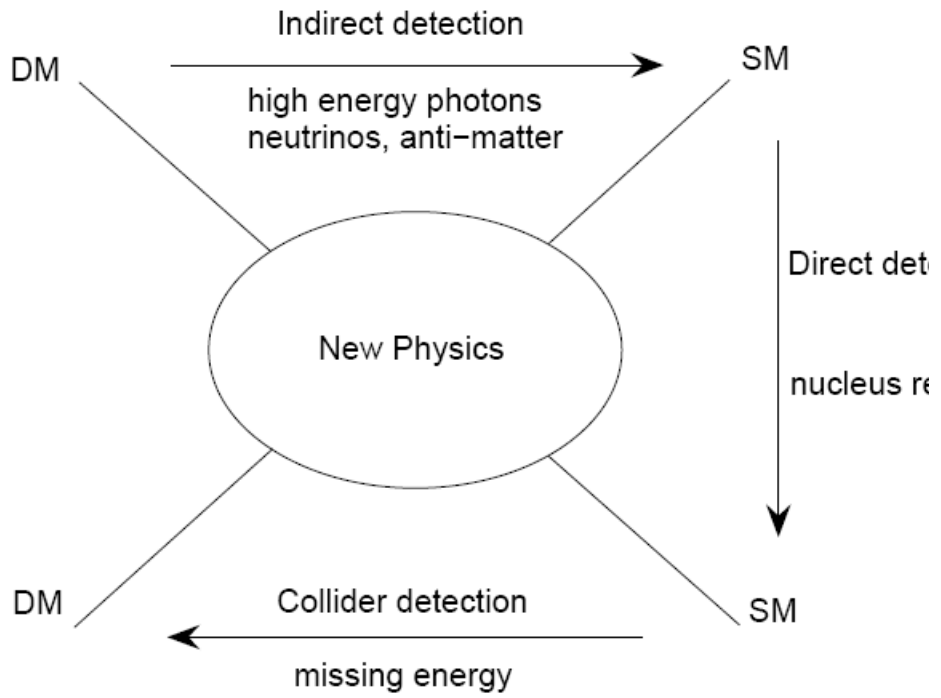
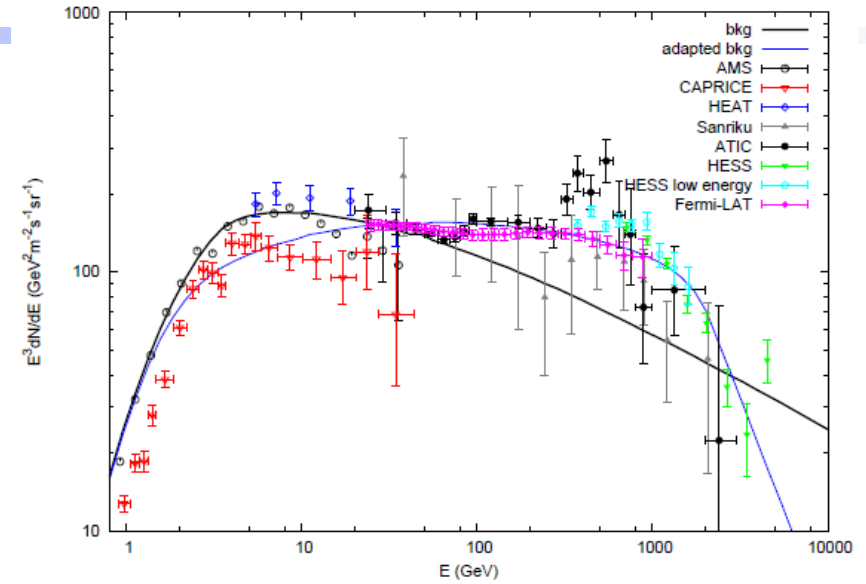
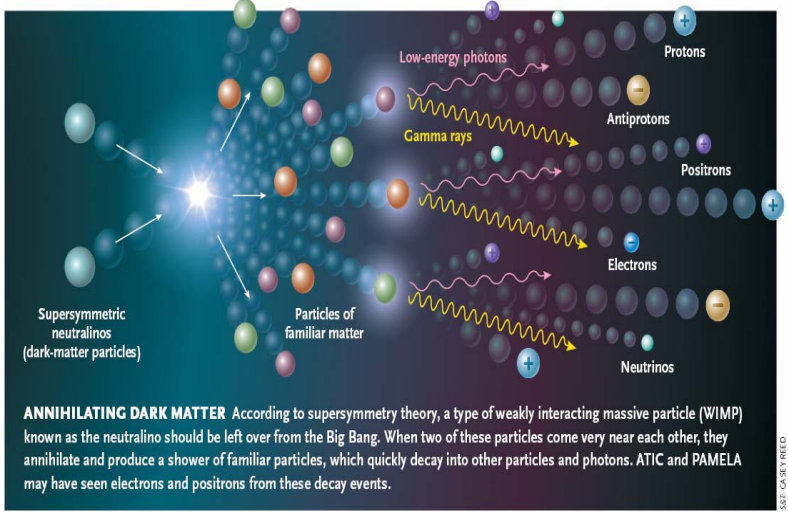

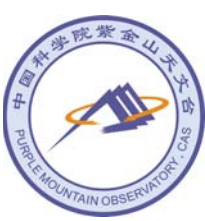

We need new accurate and very-high-statistics observation for searching Dark Matter in the sub-TeV to the trans-TeV region with a detector which has large exposure, high energy resolution, high space resolution and low background.

Science, 20 May, 2011

SPACE SCIENCE

Chinese Academy Takes Space Under Its Wing



Dark Matter Particle Explorer Satellite

LOFTY AMBITIONS

Mission	Chief scientist	Goals	Estimated launch
HXMT	Li Tipei, CAS Institute of High Energy Physics and Tsinghua University	Survey of x-ray sources; detailed observations of known objects	2014
Shijian-10	Hu Wenrui, CAS Institute of Mechanics	Study physical and biological systems in microgravity and strong radiation environment	Early 2015
KuaFu Project	William Liu, Canadian Space Agency and CAS Center for Space Science and Applied Research	Study solar influence on space weather	Mid-2015
Dark Matter Satellite	Chang Jin, CAS Purple Mountain Observatory	Search for dark matter; study cosmic ray acceleration	Late 2015
Quantum Science Satellite	Pan Jianwei, University of Science and Technology of China	Quantum key distribution for secure communication; long-distance quantum entanglement	2016

Strategic Priority Research Program in Space Science

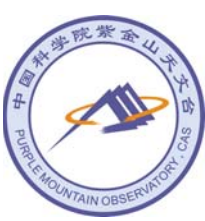

Collaborating institutes

Purple Mountain Observatory (PMO), CAS, Nanjing
University of Science and Technology of China (USTC), Hefei
Institute of Modern Physics (IMP), CAS, Lanzhou
Institute of High Energy Physics (IHEP), CAS, Beijing
National Space Science Center, CAS, Beijing
DPNC, University of Geneva, Geneva
INFN Perugia



Scientific Objectives

- Cosmic ray
- Gamma-ray astronomy
- Dark matter particle



Dark Matter Particle Explorer (DAMPE)

Energy range: 1GeV-10 TeV

Particle: electron, gamma-ray, heavy ions

Energy resolution: (1.5% @800GeV)

Space resolution: (0.5degree@800GeV)

Background level (<1% @800GeV)

e/p separation: 10^{5-6}

GF: $0.3\text{m}^2.\text{sr}$

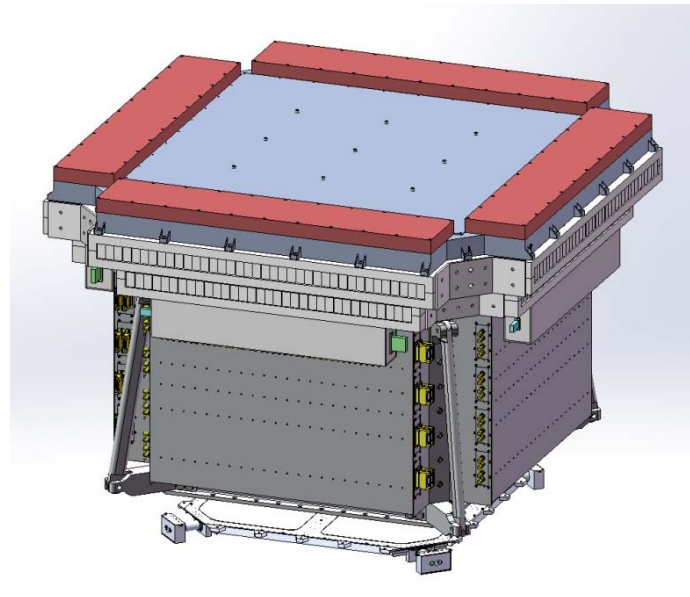
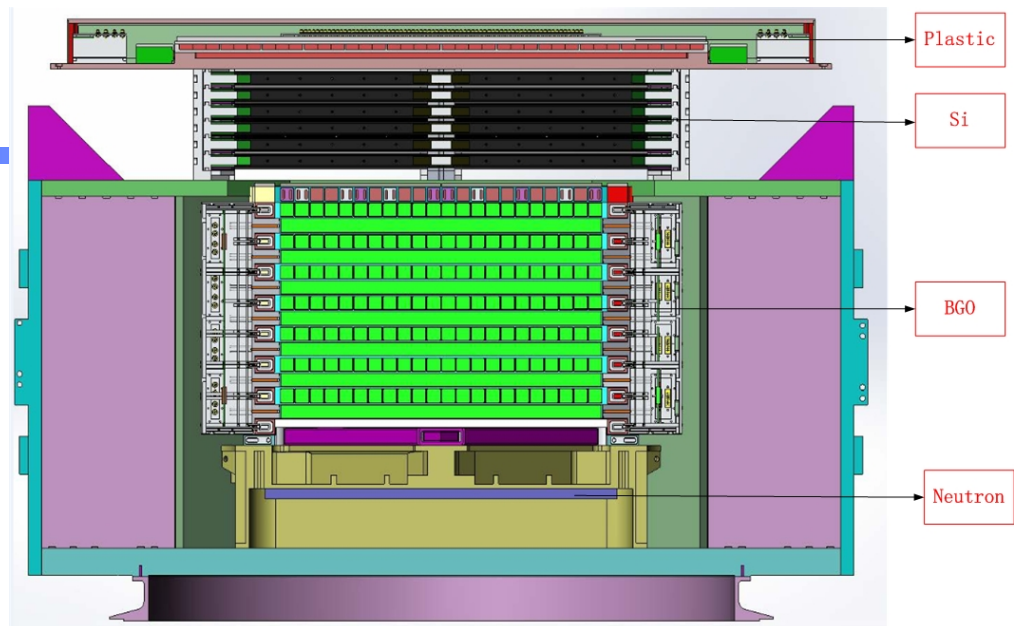
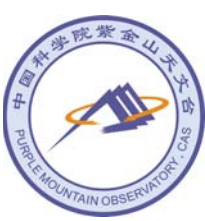

The detector is consisted of 4 parts:
Top plastic scintillators (charge measurement)
Si tracker (6 layers)
BGO calorimeter
Neutron detector

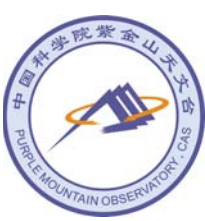

Top hodoscope array

- ❑ Charge measurement (From $Z=1$ to $Z=28$).
- ❑ Anticoincidence (for gamma-ray observation)
- ❑ Cross section: $2.5\text{cm} \times 1\text{cm}$ Length: 82cm
- ❑ Readout: PMT (two dynodes)+VA chip

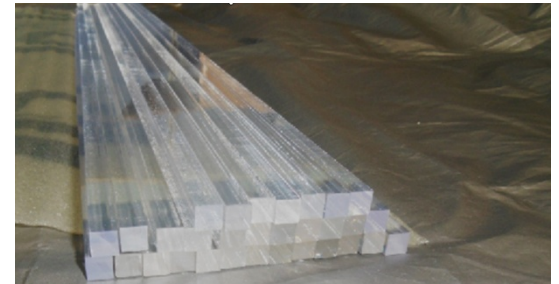

Charge resolution: $25\% @ Z=1$

Detection eff. $>99\%$

Weight: 95Kg

Size: $1.18 \times 0.89 \times 0.12\text{m}$

Power consumption: 50W

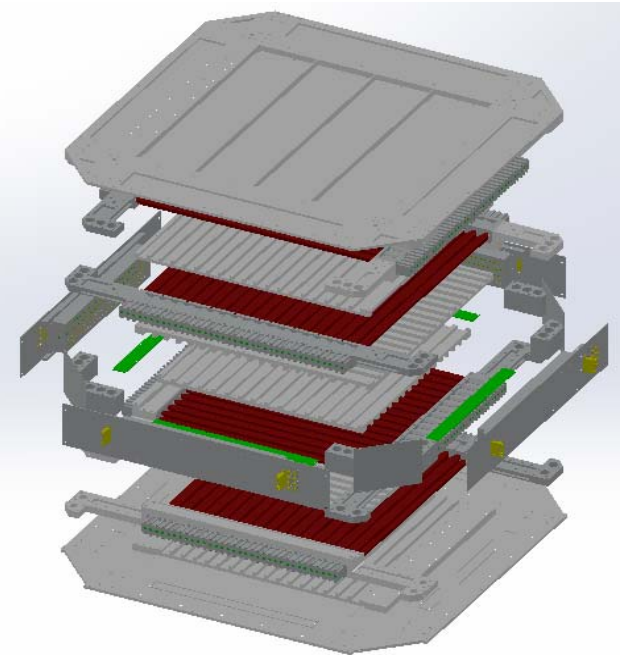

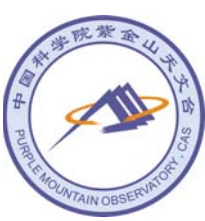

Si tracker

- ❑ 6 layers, 76cmX76cm
 - Integrated Tungsten converter plates into a tracker with Si strip detectors
 - ❑ γ converts in W plate to $e^+e^- \rightarrow$ detected in subsequent Si detectors
 - Unambiguous identification of γ -ray , superior pointing resolution
 - ❑ 3 converter layers, total **67 kg** of W, thickness 1x1 mm + 2x2 mm = 1.43 X_0
 - ❑ A tracking plane is made of 2x8 ladders head to head
 - ❑ 7 tray of 4 types: no-W thin tray, no-W thick tray, thin-W tray, thick-W tray
 - **Support of thin tray ~ 15 mm, Support of thick tray ~ 30 mm**

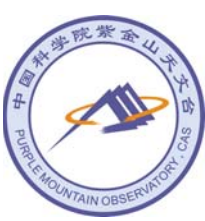

BGO calorimeter

Energy measurement from GeV-100 TeV

e/P separation 10^4 ($31.25 X_0$)

308 crystals ($2.5\text{cm} \times 2.5\text{cm} \times 60\text{cm}$)

Readout: PMT from both sides

each PMT: 3 dynodes + VA

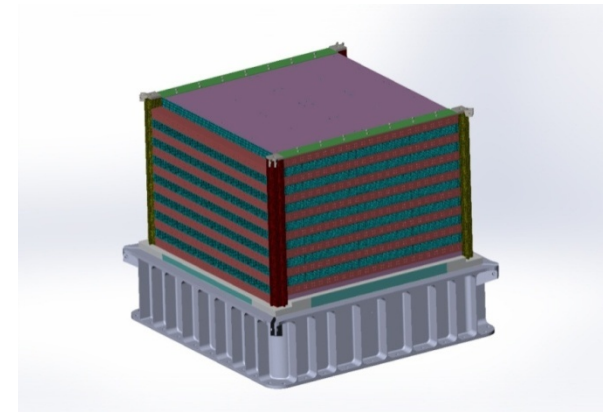
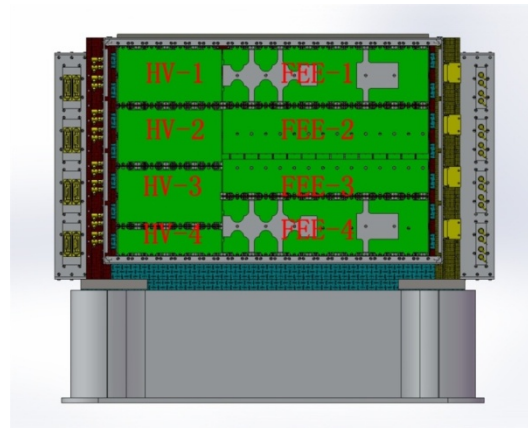
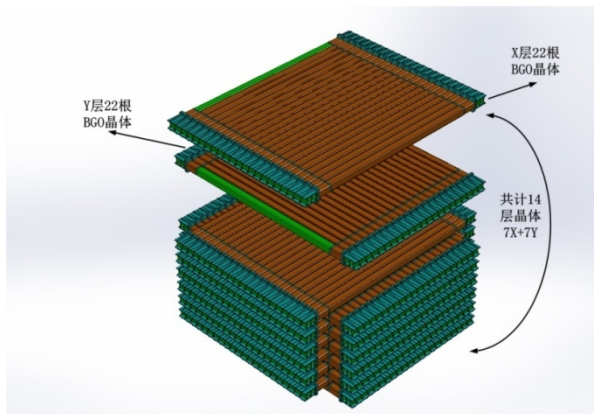

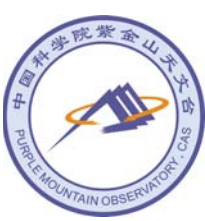

PMT readout

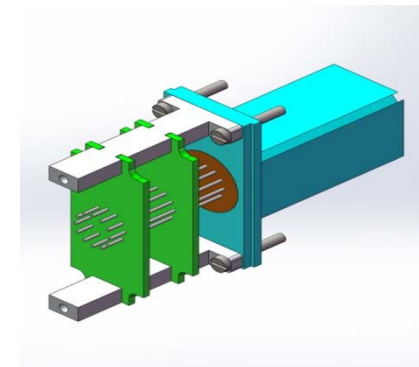
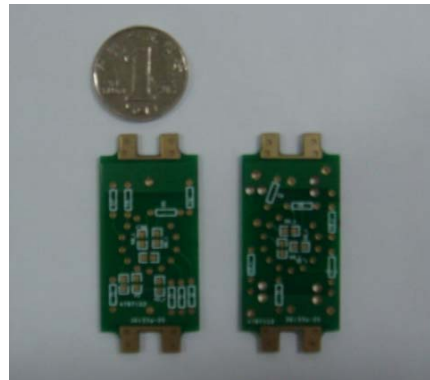
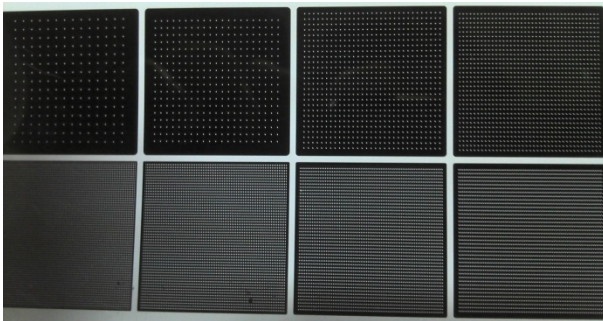
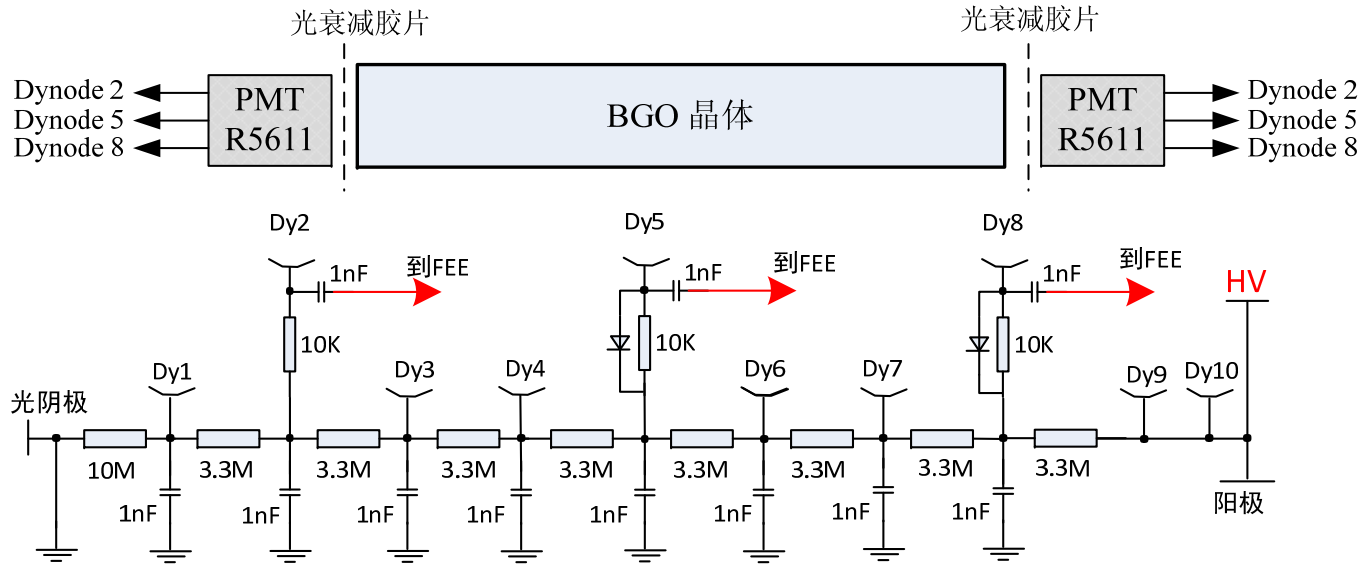

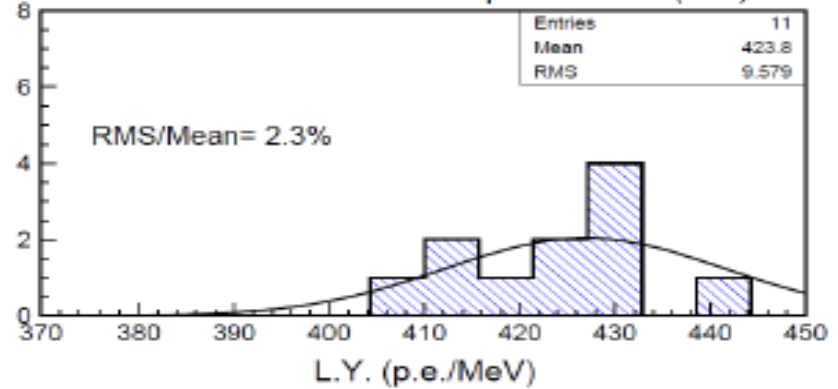
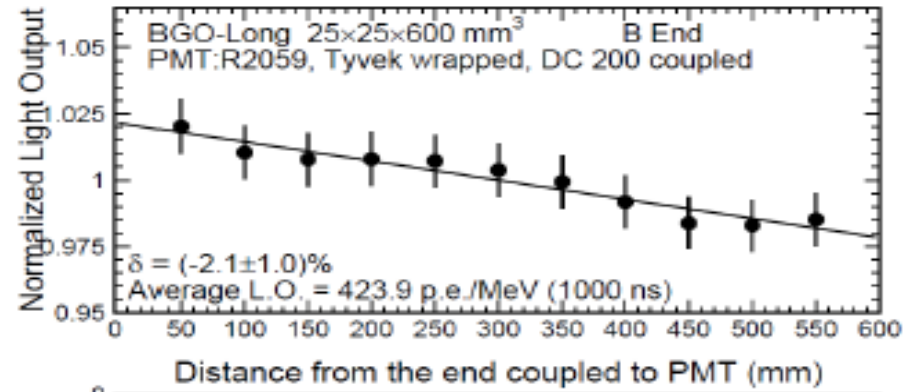
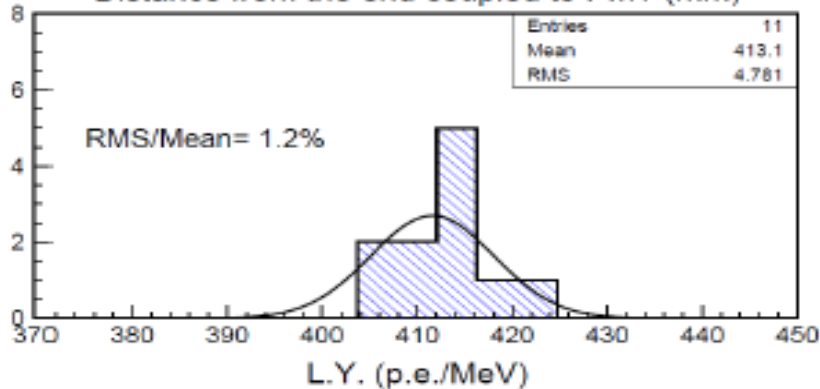
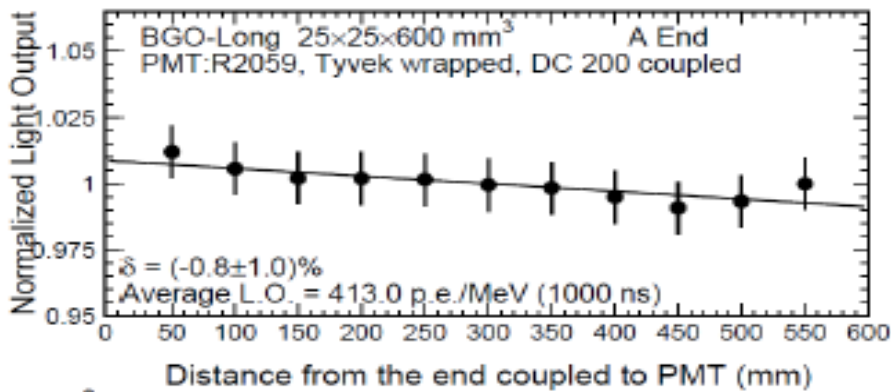
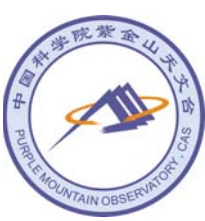

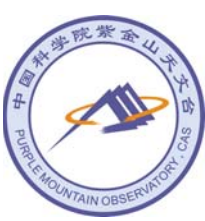

BGO dynamic range test

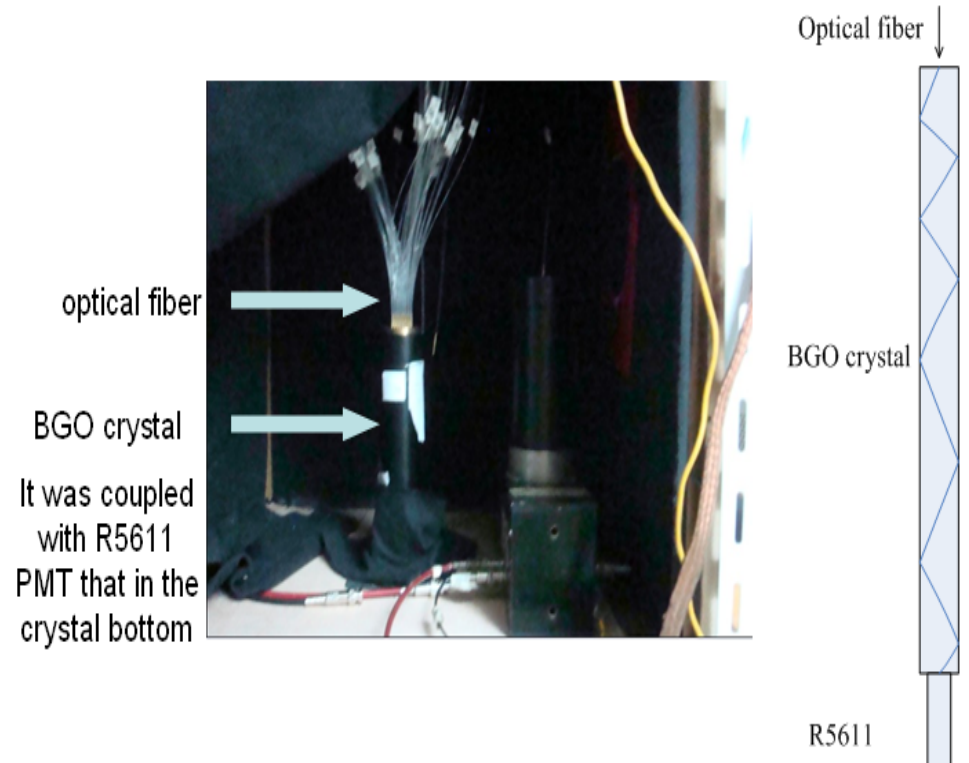

Using one readout: Dynamic range 200,000

2 end readout: 2,000,000

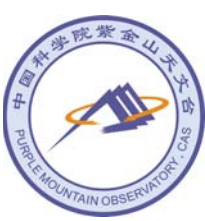

Neutron Detector

- ❑ Using time window, neutron detector for e/P separation。
- ❑ BC454 (5% B, size 600mm × 600mm × 10mm)
- ❑ Read out: PMT
- ❑ Simulation: >10-100 e/P separation

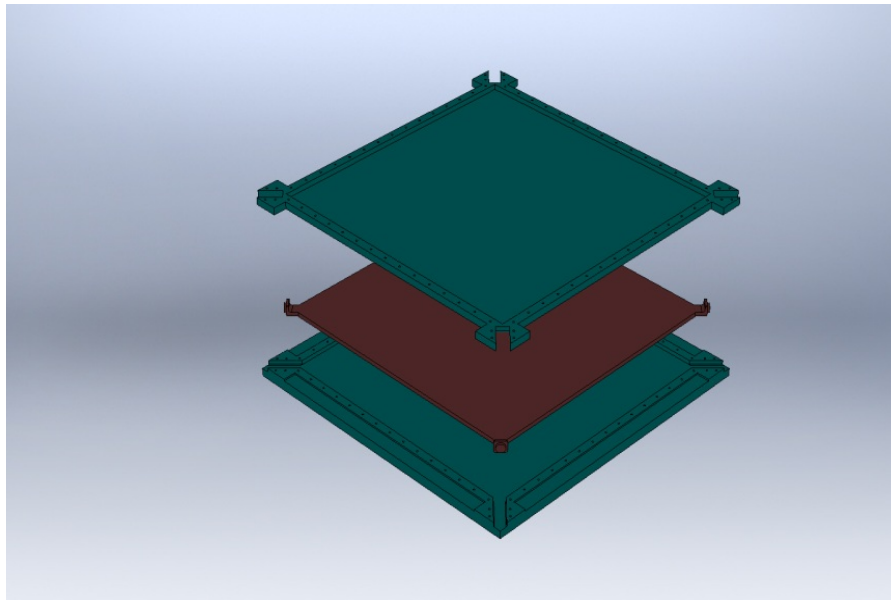



Energy deposit in Neutron detector

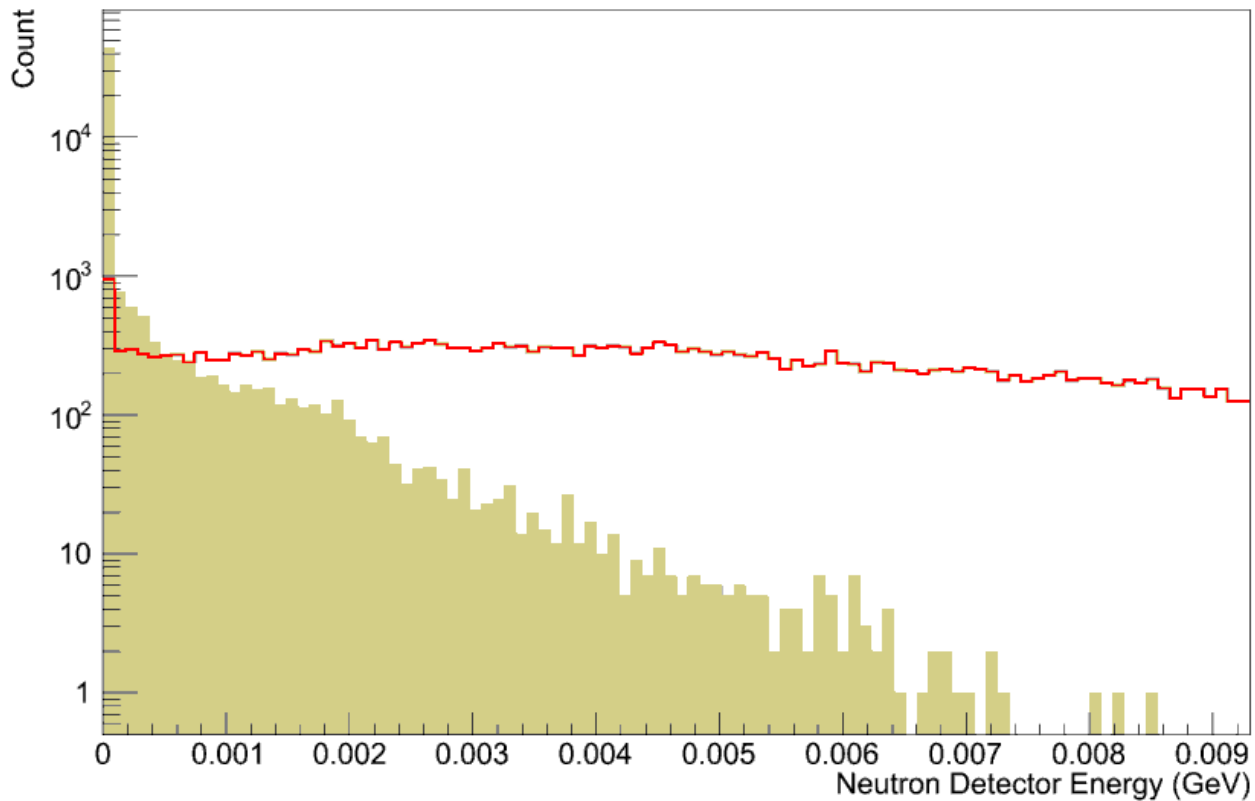

500GeV energy deposit in BGO for electron (yellow) and proton (red)



High energy Resolution

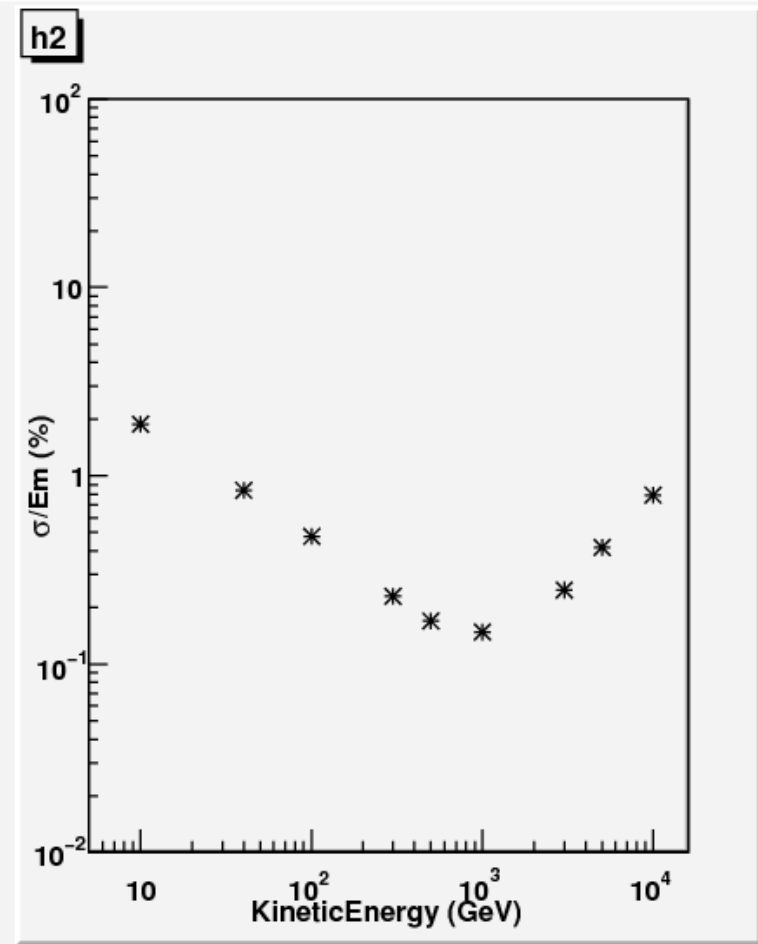
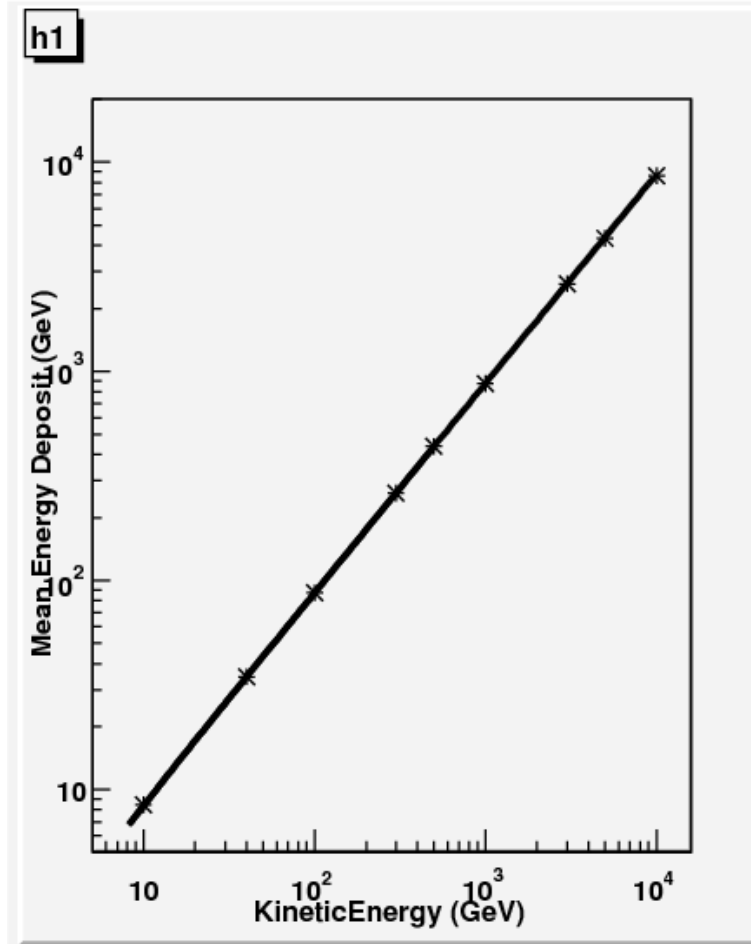

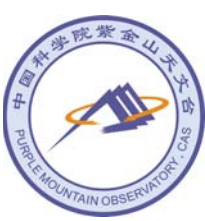

High e/p separation

CALET

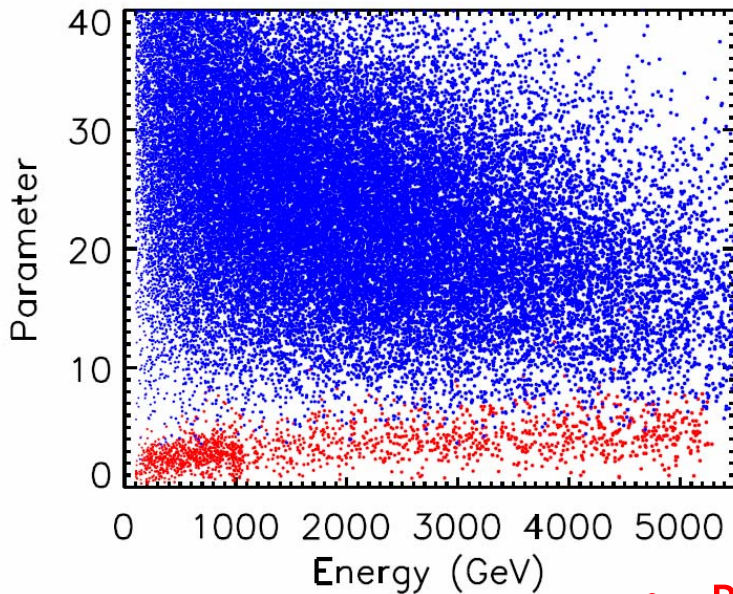

DAMPE

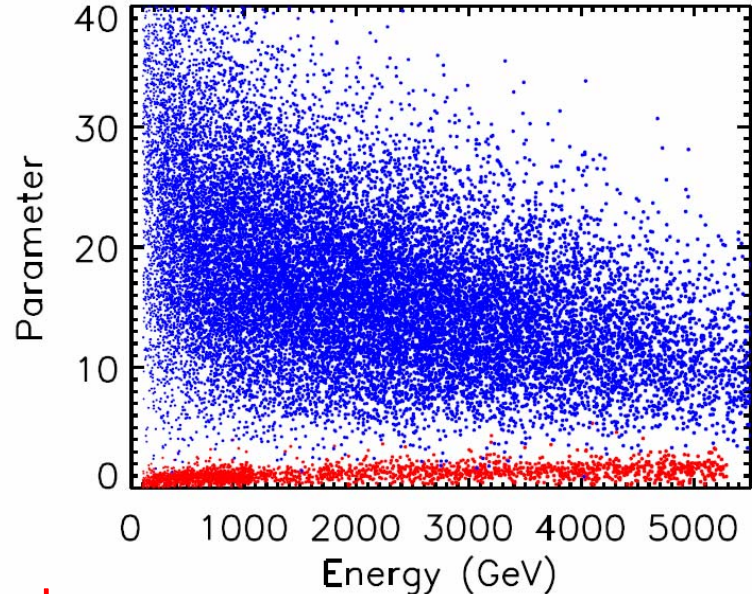

- Red: electron
- Blue: Proton

Mission	ATIC	FERMI	AMS	CALET	DAMPE
Depth	24	10.1	17	30	34



DAMPE Mission

- Approved for construction (phase C/D) in Dec. 2011
- Scheduled launch date 2015

- Satellite < 1900 kg, payload ~1340kg
- Power consumption 840W
- Lifetime > 3 years
- Launched by CZ-2D rockets

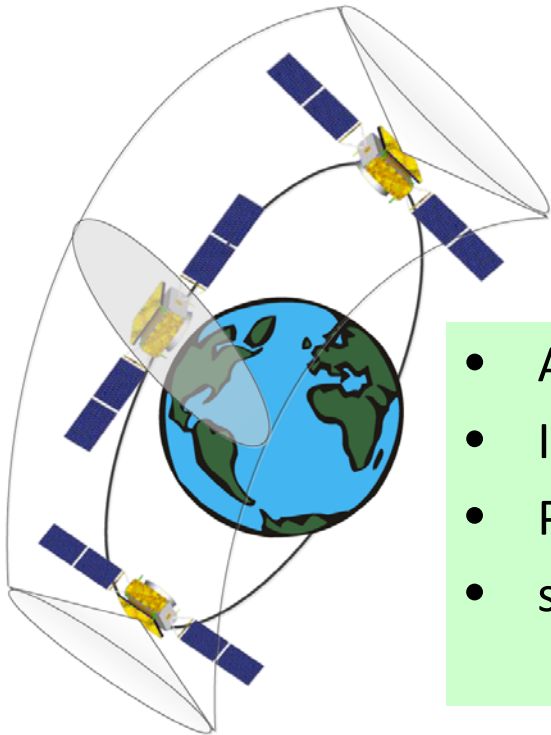

- Altitude 500 km
- Inclination 97.4065°
- Period 90 minutes
- sun-synchronous orbit

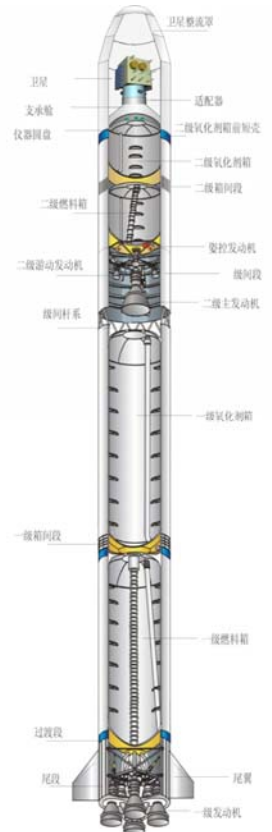

Beam Test in CERN



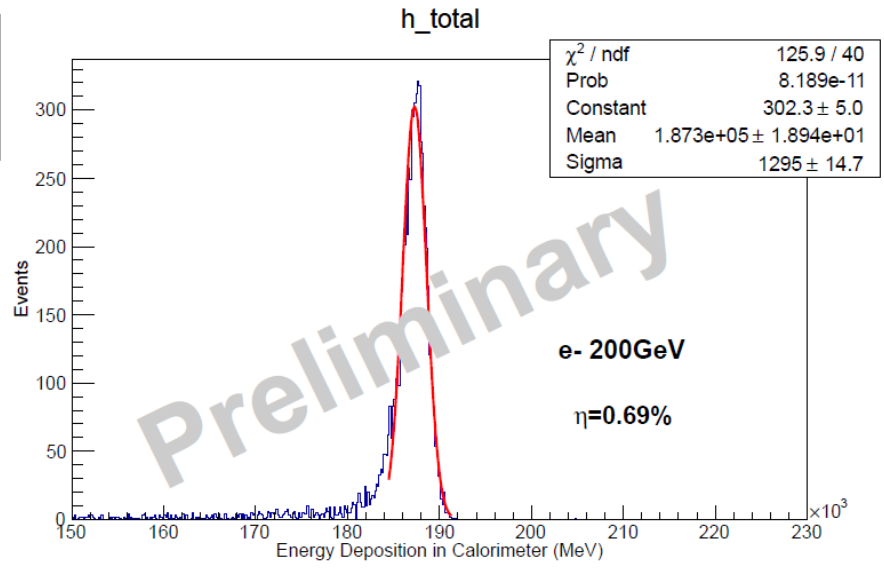
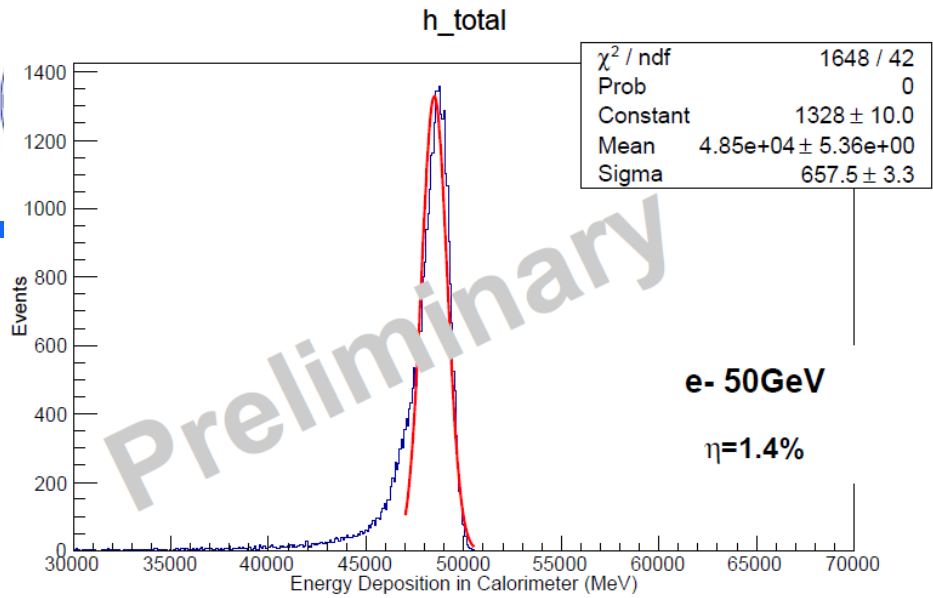

These results agree with simulation very well

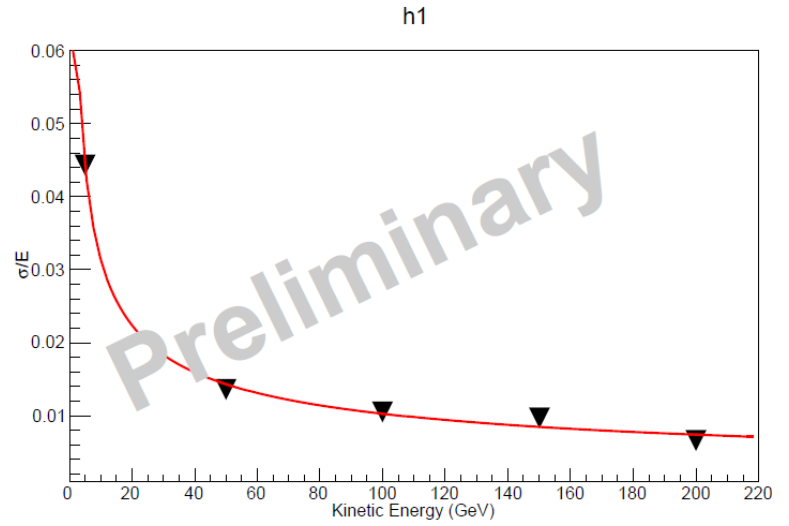
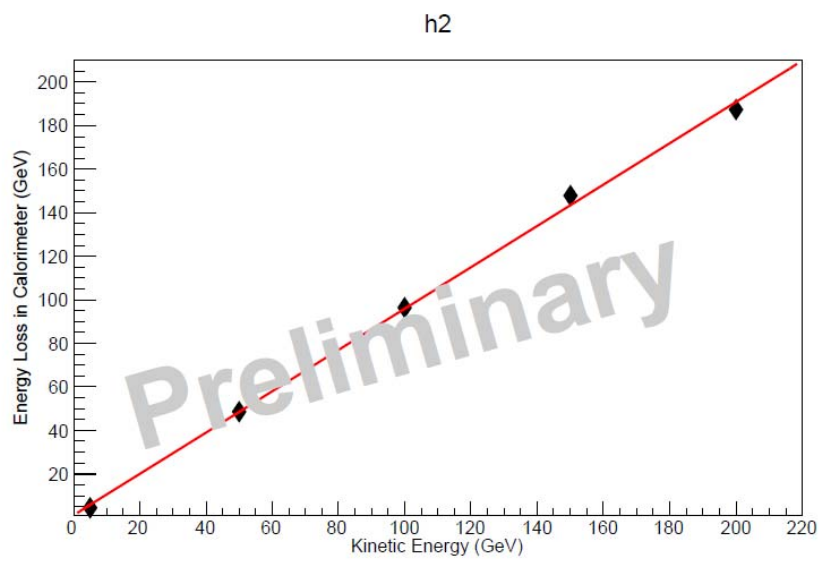



Test for structure of whole detector



2013-02-27

Comparison of Detector Performance for Electrons

DAMPE is optimized for the electron observation in the trans-TeV region, and the performance is best also in 10-1000 GeV.

Detector	Energy Range (GeV)	Energy Resolution	e/p Selection Power	Key Instrument (Thickness of CAL)	S Ω T (m ² srday)
ATIC1+2 (+ ATIC4)	10 - a few 1000	<3% (>100 GeV)	~10,000	Thick Seg. CAL (BGO: 22 X ₀) + C Targets	3.08
PAMELA	1-700	5% @200 GeV	10 ⁵	Magnet+IMC (W:16 X ₀)	~1.4 (2 years)
FERMI-LAT	20-1,000	5-20 % (20-1000 GeV)	10 ³ -10 ⁴ (20-1000GeV) Energy dep. GF	Tracker+ACD + Thin Seg. CAL (W:1.5X ₀ +CsI:8.6X ₀)	60@TeV (1 year)
AMS	1-1,000 (Due to Magnet)	~2-4% @100 GeV	10 ⁴ (x 10 ² by TRD)	Magnet+IMC +TRD+RICH (Lead: 17X ₀)	~50(?) (1year)
CALET	1-10,000	~2-3% (>100 GeV)	~10 ⁵	IMC+CAL (W: 3 X ₀ + PWO : 27 X ₀)	44 (1years)
DAMPE	1-10,000	~1% (>100 GeV)	~10⁵-10⁶	IMC+CAL+Neutron (W: 2 X₀+ BGO: 32 X₀)	180 (1 years)

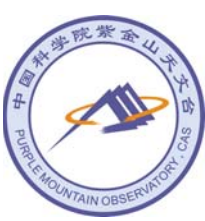

More detailed and accurate description about DAMPE is to be represented in the 33rd International Cosmic Ray Conference (ICRC2013) next month by our technical experts.



High energy resolution for line searching

Region	E_0 GeV	Fermi-LAT			DAMPE		
		$N_{\text{sig}}/N_{\text{bkg}}$	significance	$t(5\sigma)$	$N_{\text{sig}}/N_{\text{bkg}}^a$	significance ^a	$t(5\sigma)^b$
Weniger Reg3	126.2	24.2/52.5	3.3	8.6	24.2/8.8	8.2	2.8
Central	130.4	17.1/13.5	4.7	4.2	17.1/2.2	11.4	1.4
West	129.8	11.8/12.0	3.4	8.1	11.8/2.0	8.4	2.6

^aAssuming the same exposure of Fermi-LAT and DAMPE;

^bThe geometry factor of DAMPE is adopted to be half of that of Fermi-LAT.

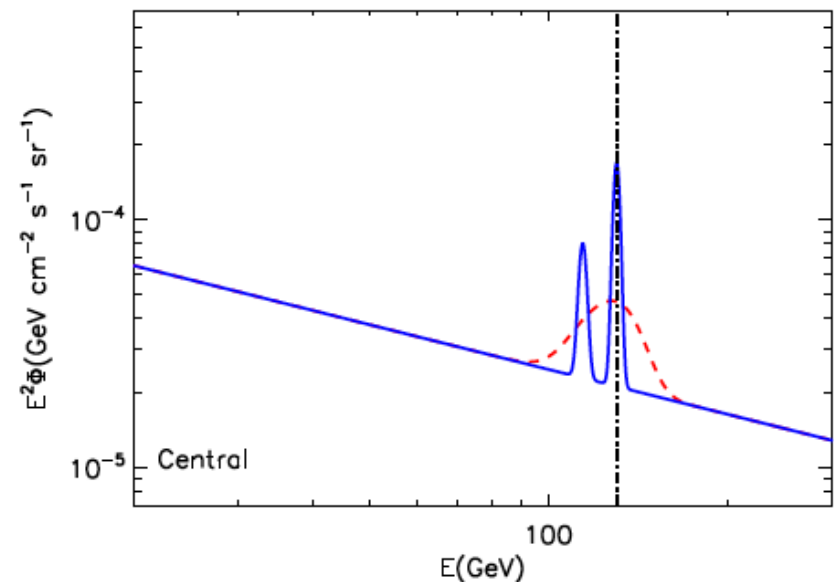
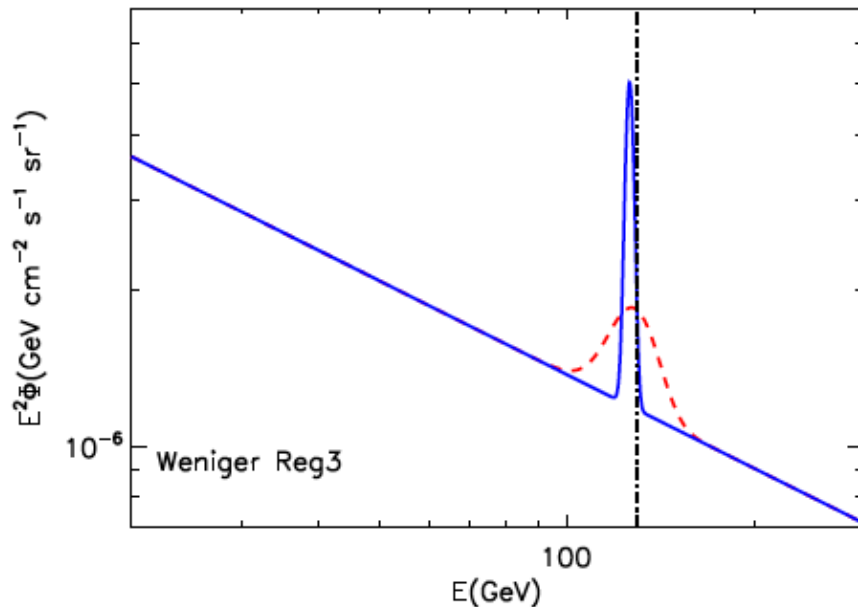

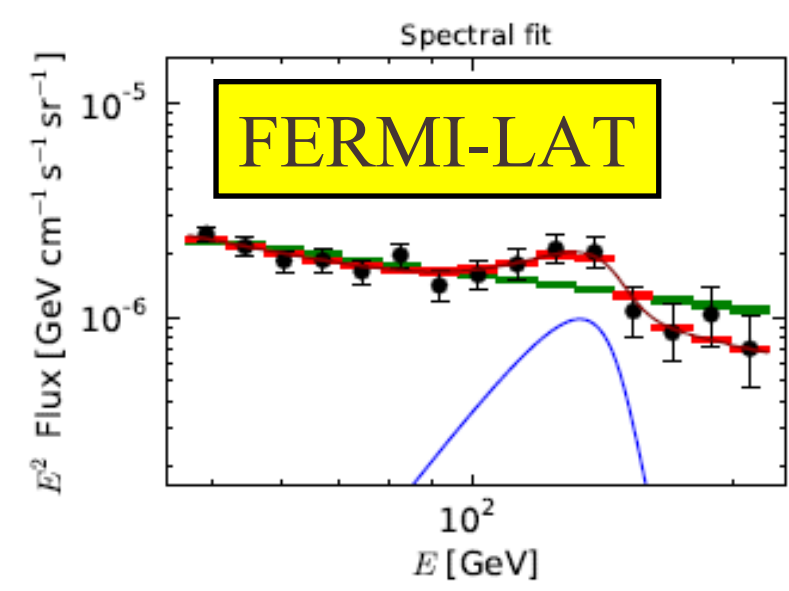
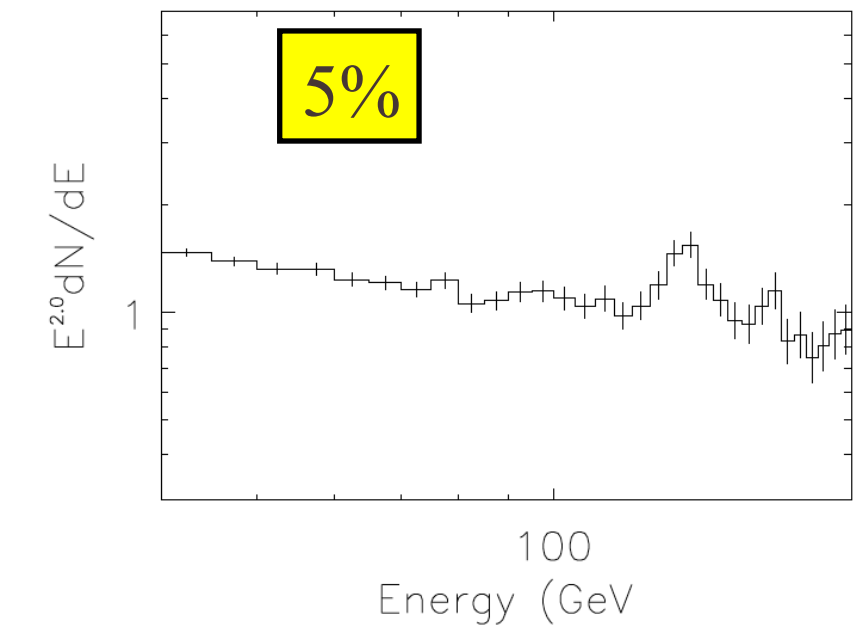
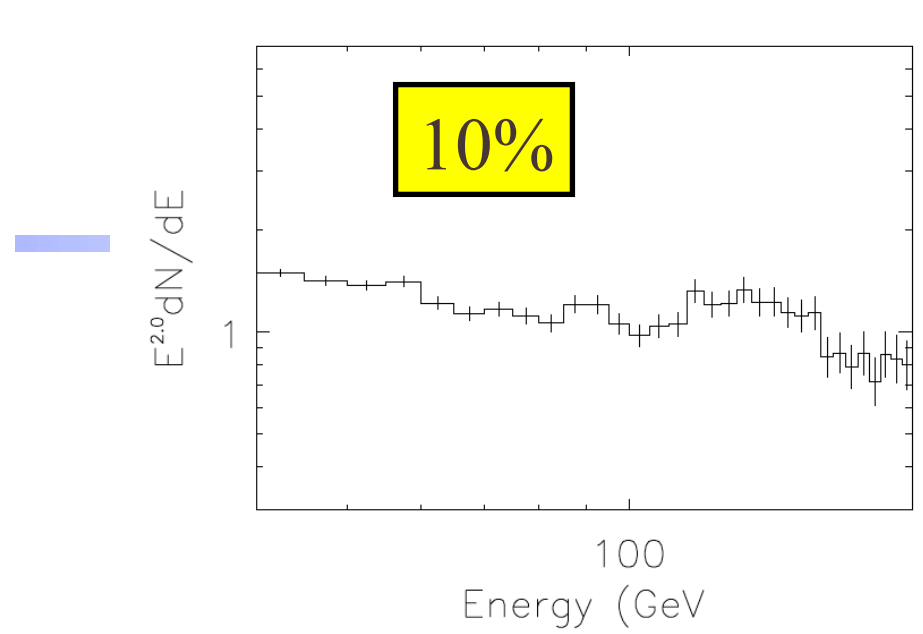
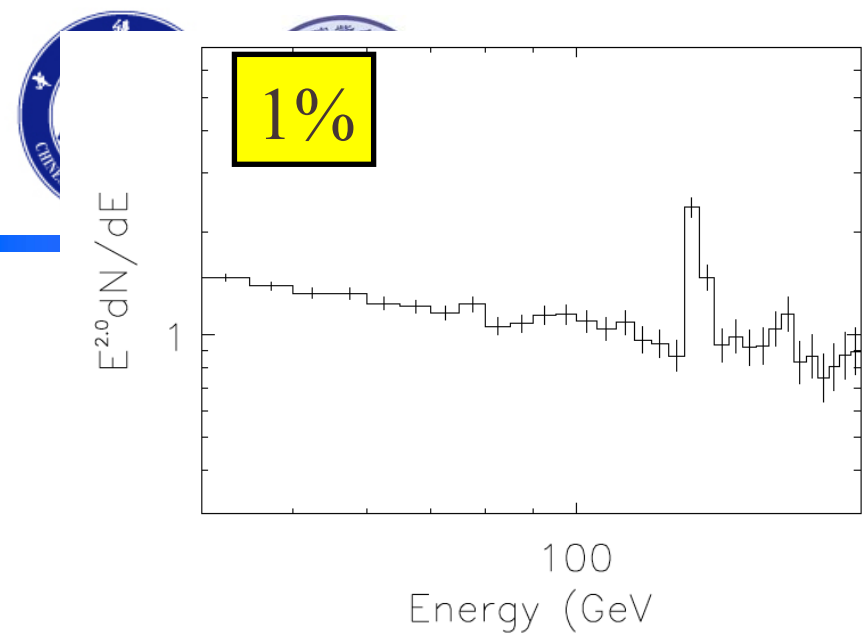



Thanks for your attention !