

# Searching for the Heavy Photon at JLab

Maurik Holtrop  
University of New Hampshire  
for the HPS and APEX Collaborations.

Patras 2013, Schloss Waldthausen, Germany, June 24<sup>th</sup>



# Dark Sector Gauge Boson

- Dark matter  $\subset$  dark sector, few portals to SM physics.
- Lots of theoretical motivation for an additional  $U(1)'$  symmetry  $\subset$  dark sector  $\Rightarrow$  new vector boson  $A'$
- $A'$  will mix with SM photon through kinetic mixing.

Holdom '86

$$\Delta\mathcal{L}_{kin.mix} = \frac{\epsilon}{2} F'_{\mu\nu} F_Y^{\mu\nu}$$

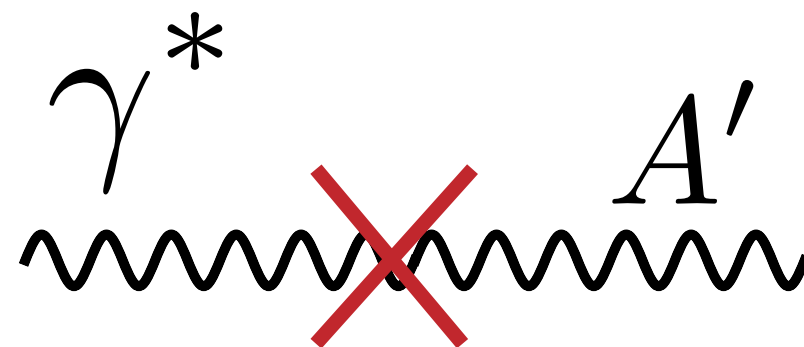
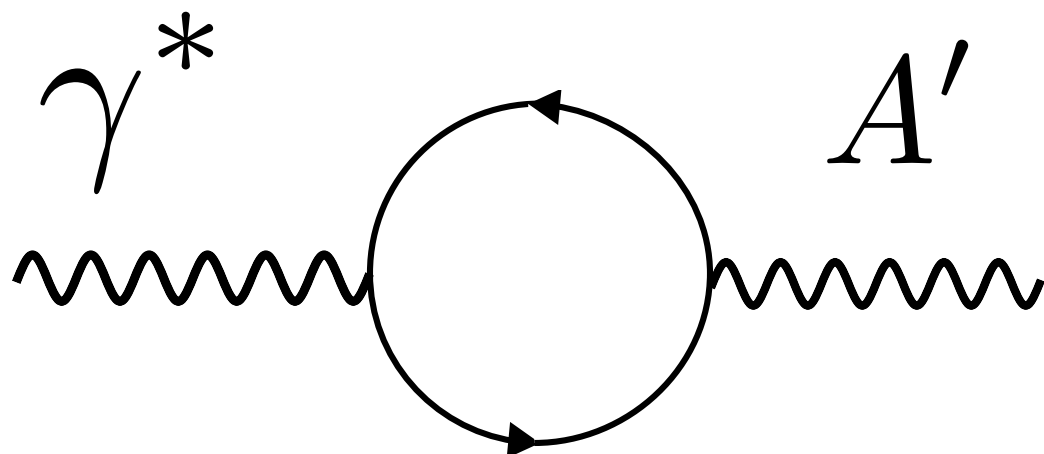

# Heavy Photons

Photon mixing with  $A'$  is equivalent to ordinary charged matter acquiring a milli-charge under the  $A'$

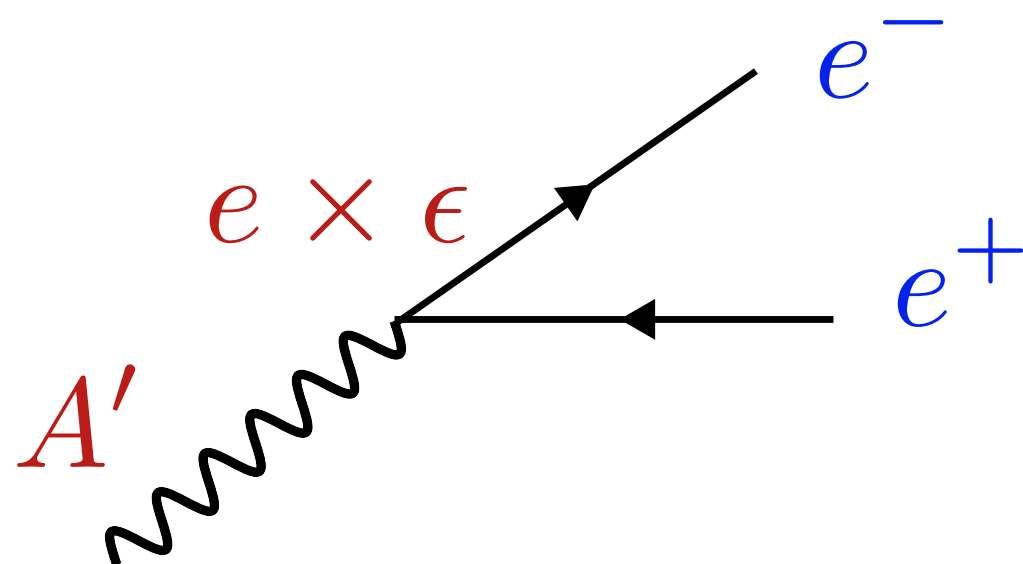
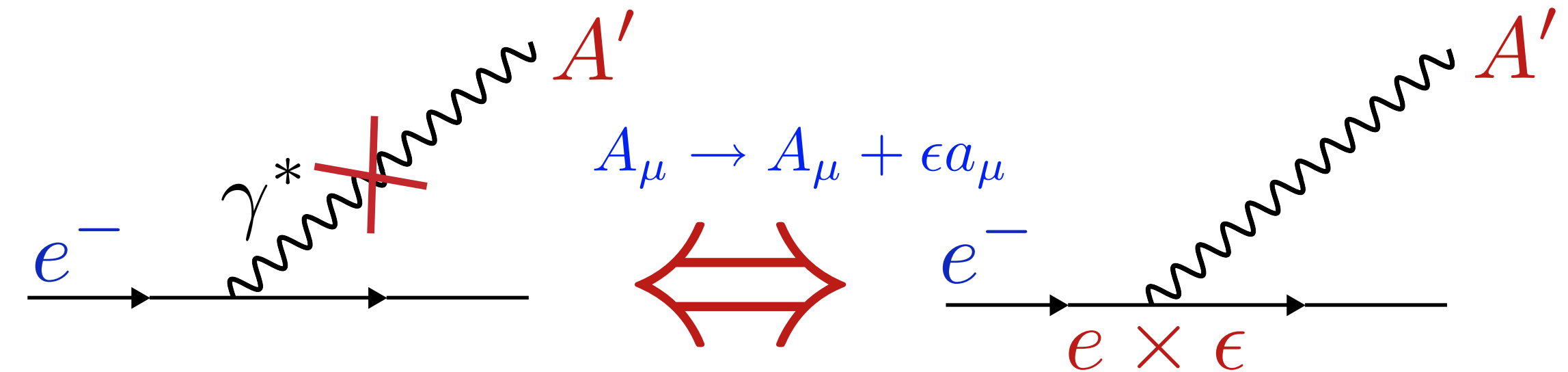

$A'$  will pair produce  $e^+e^-$ ,  $\mu^+\mu^-$ ,  $\pi^+\pi^-$ , ...

# Where could it be?

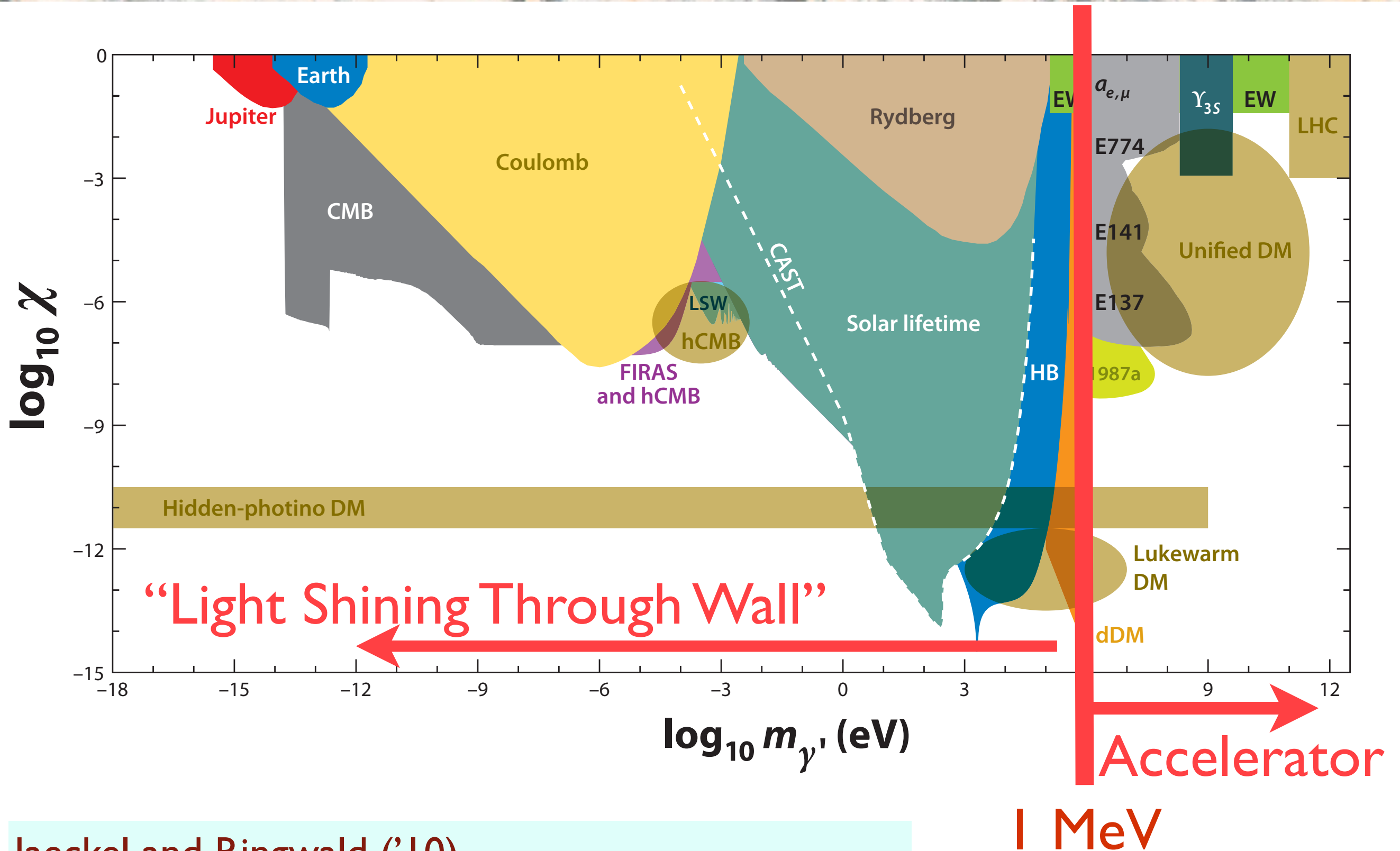

Jaeckel and Ringwald ('10) *Ann.Rev. of Nuclear and Particle Science*, 60(1), 405–437



# Search Range

Couplings to the SM can be generated “naturally”

Mass from:  $m_{A'}^2 \sim \epsilon M_W^2$  or  $m_{A'}^2 \sim \frac{eg_D}{16\pi^2} M_W^2$

Intermediate state can be at any scale, i.e. Plank scale

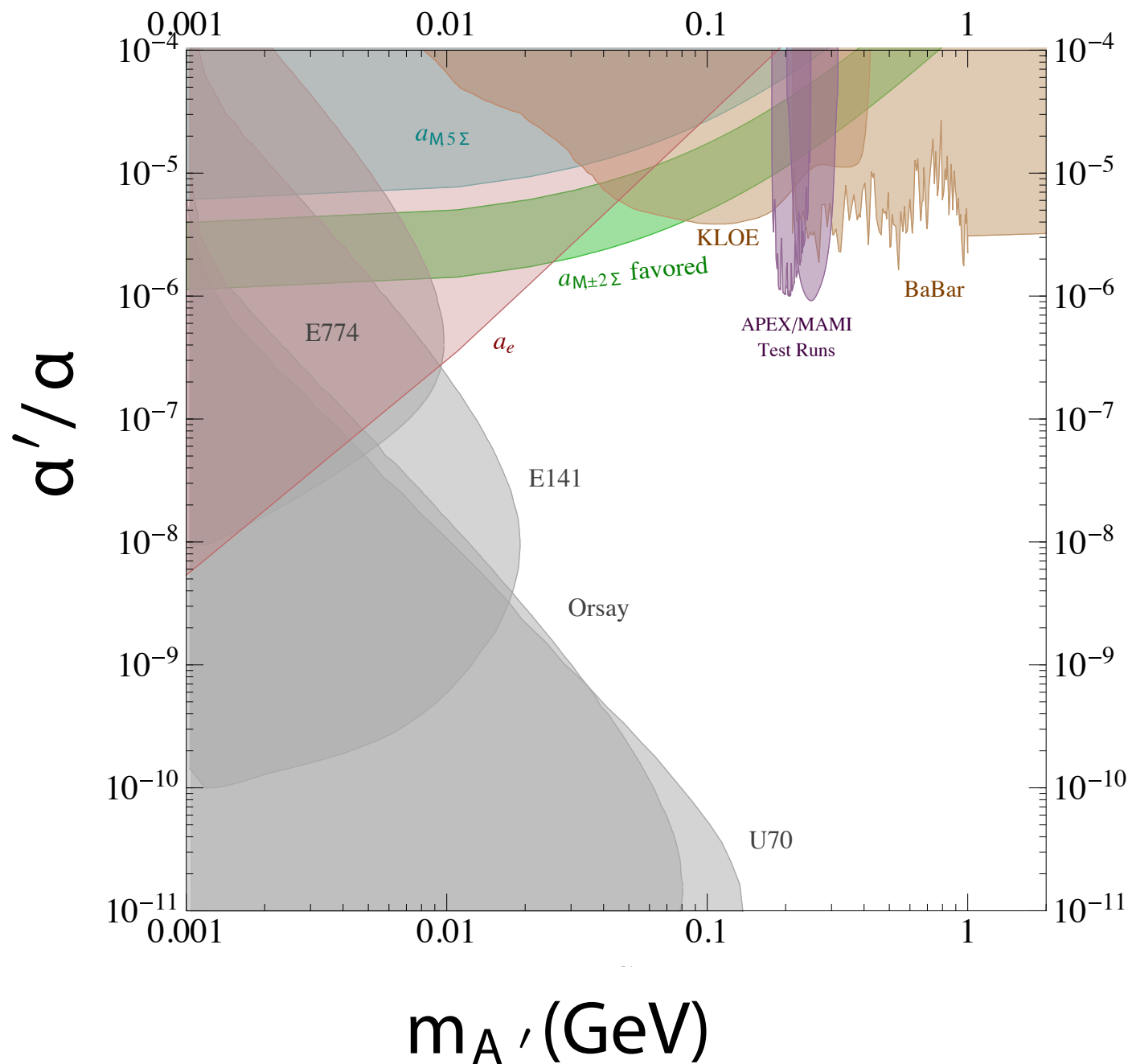

one-loop

two-loop  
(GUT)

three-loop

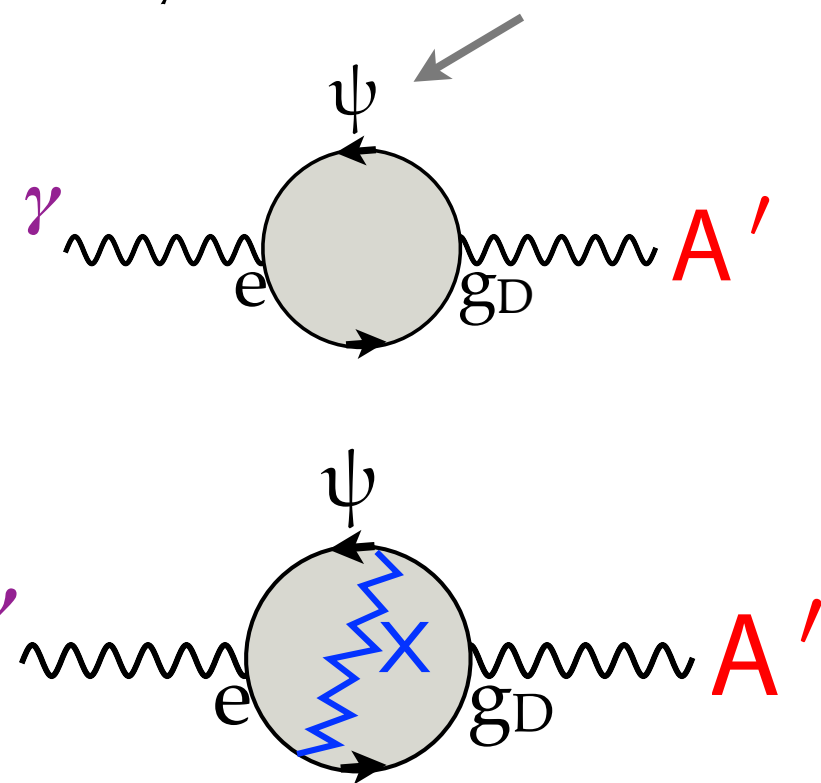

See: P. Shuster, R. Essig et al, Intensity Frontier VWS '11 summary paper.

# Fixed Target Searches

Look for radiated  $A'$  decay to  $e^+e^-$ ,  $(\mu^+\mu^-)$

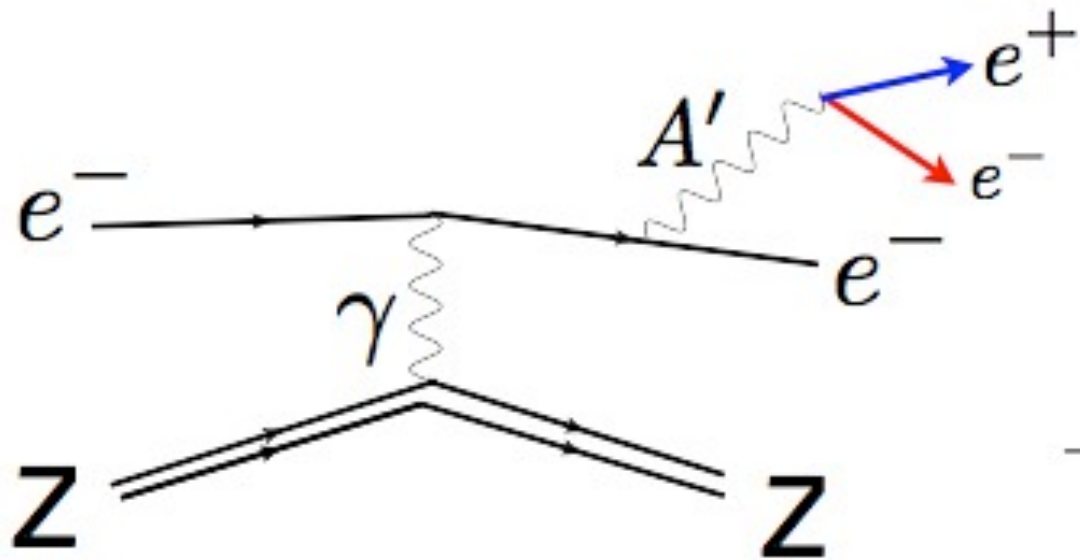

$\sigma_{B-H}$  very large  $\gg \sigma_{Rad}$ .  
But kinematically distinct  $\rightarrow$   
Use clever trigger to separate.

Bethe-Heitler

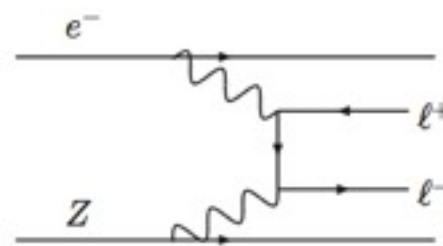

Radiative

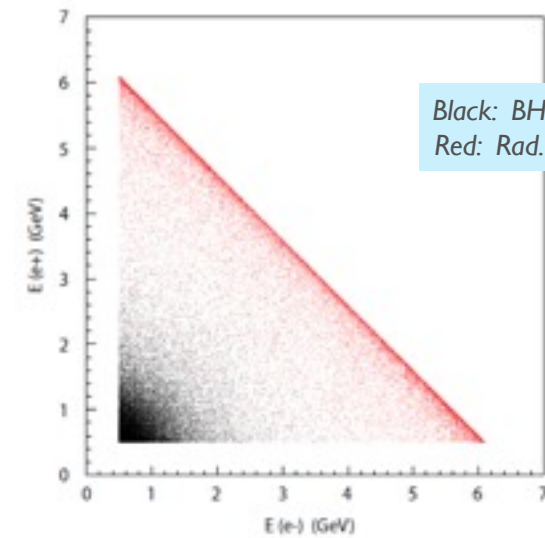
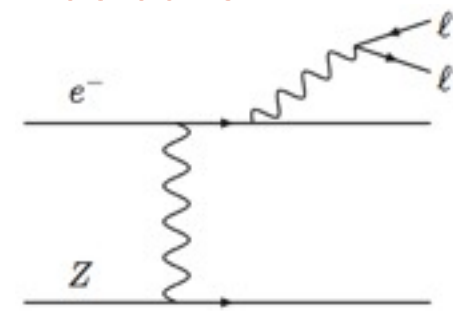

Black: BH  
Red: Rad.

**Very high luminosities:  
Intensity Frontier Physics.**

P. Shuster, R. Essig et al, Intensity Frontier WS '11  
summary paper.

**Bump Hunt:**

Look for signal over background.

**Bump Hunt + Vertexing:**

Look for signal over background,  
reduce background with vertexing.

# A' lifetime

$$\gamma c\tau \approx 1 \text{ mm} \left(\frac{\gamma}{10}\right) \left(10^{-8} \frac{\alpha}{\alpha'}\right) \left(\frac{100 \text{ MeV}}{m_{A'}}\right)$$

Lower  $\alpha'$ , lower mass  
 → longer lifetime

Background is all prompt  
 → Lower coupling can be reached using vertexing.

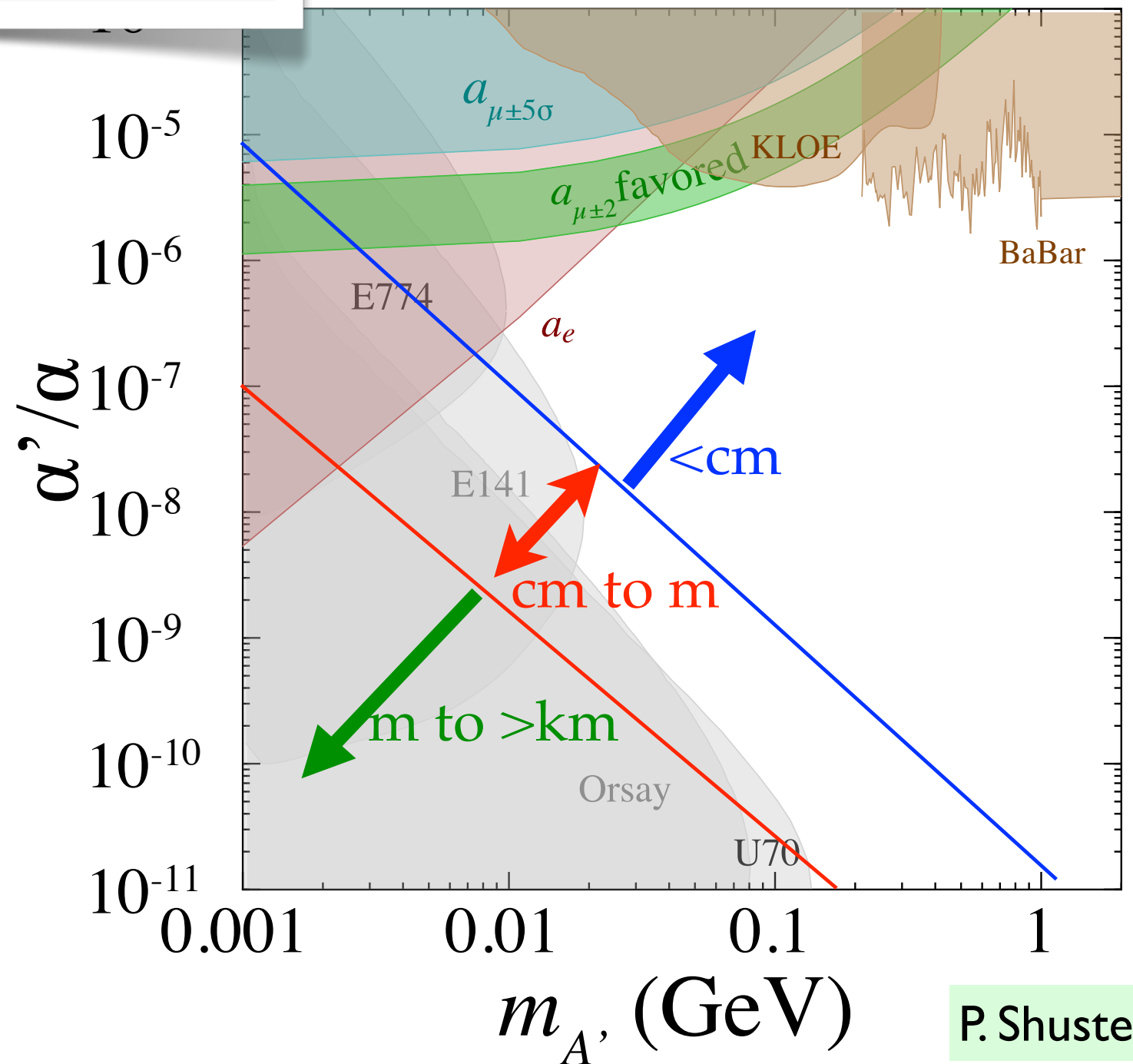

P. Shuster

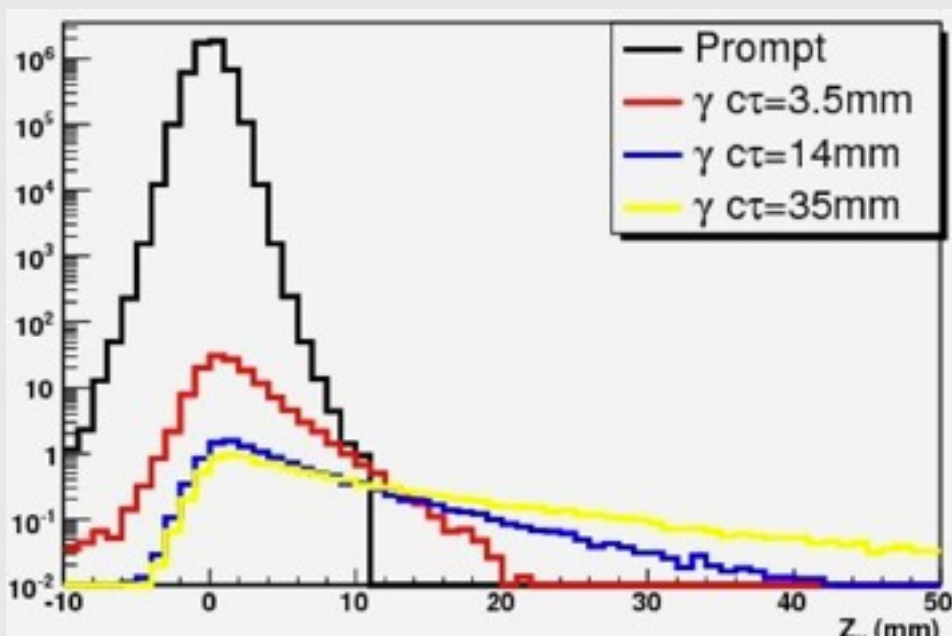



# Detecting $A'$ decays

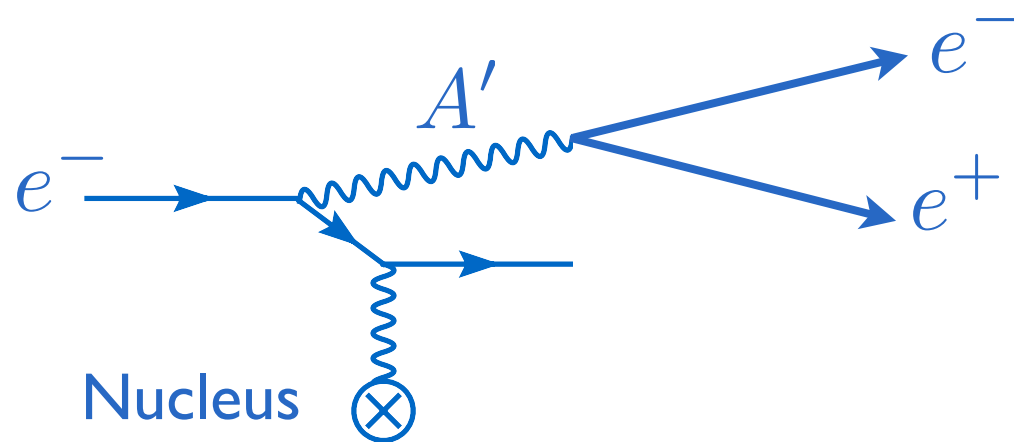
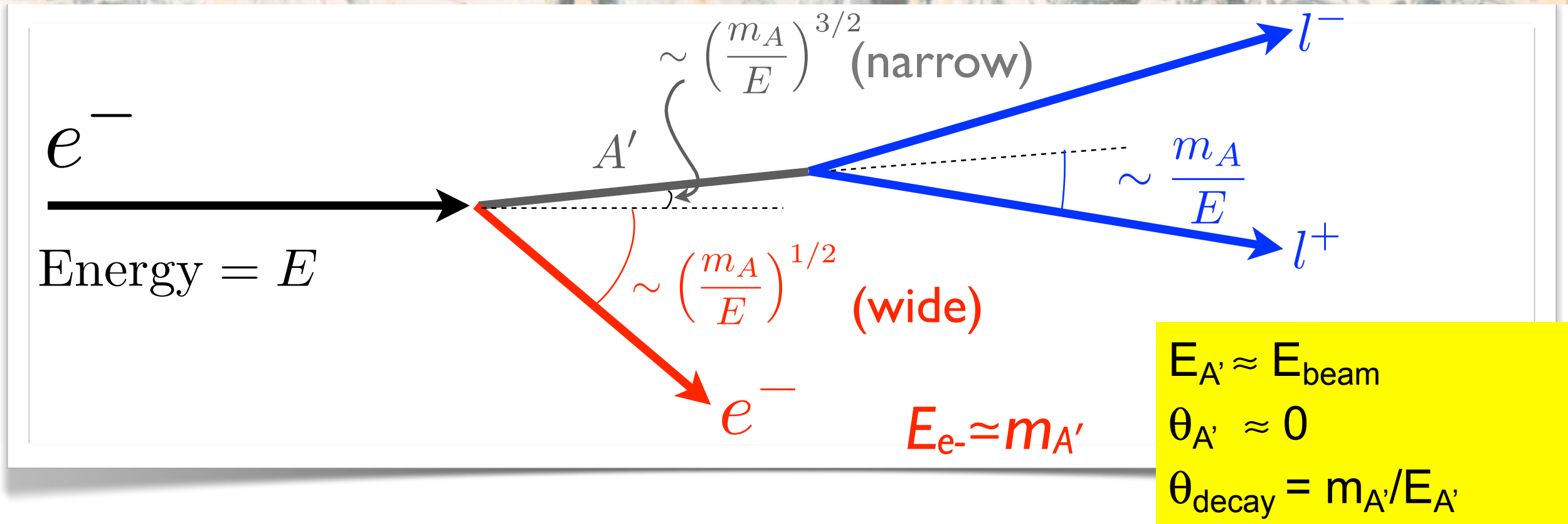

Need:

- Small angle detection of  $e^+ e^-$
- Very high luminosity
- Good invariant mass resolution



# Solution 1 - APEX

## The $A'$ Experiment (**APEX**) Searching for New Gauge Bosons in the $A'$ Experiment at Jefferson Laboratory

Use the existing high resolution spectrometers in Hall-A

Special target design.

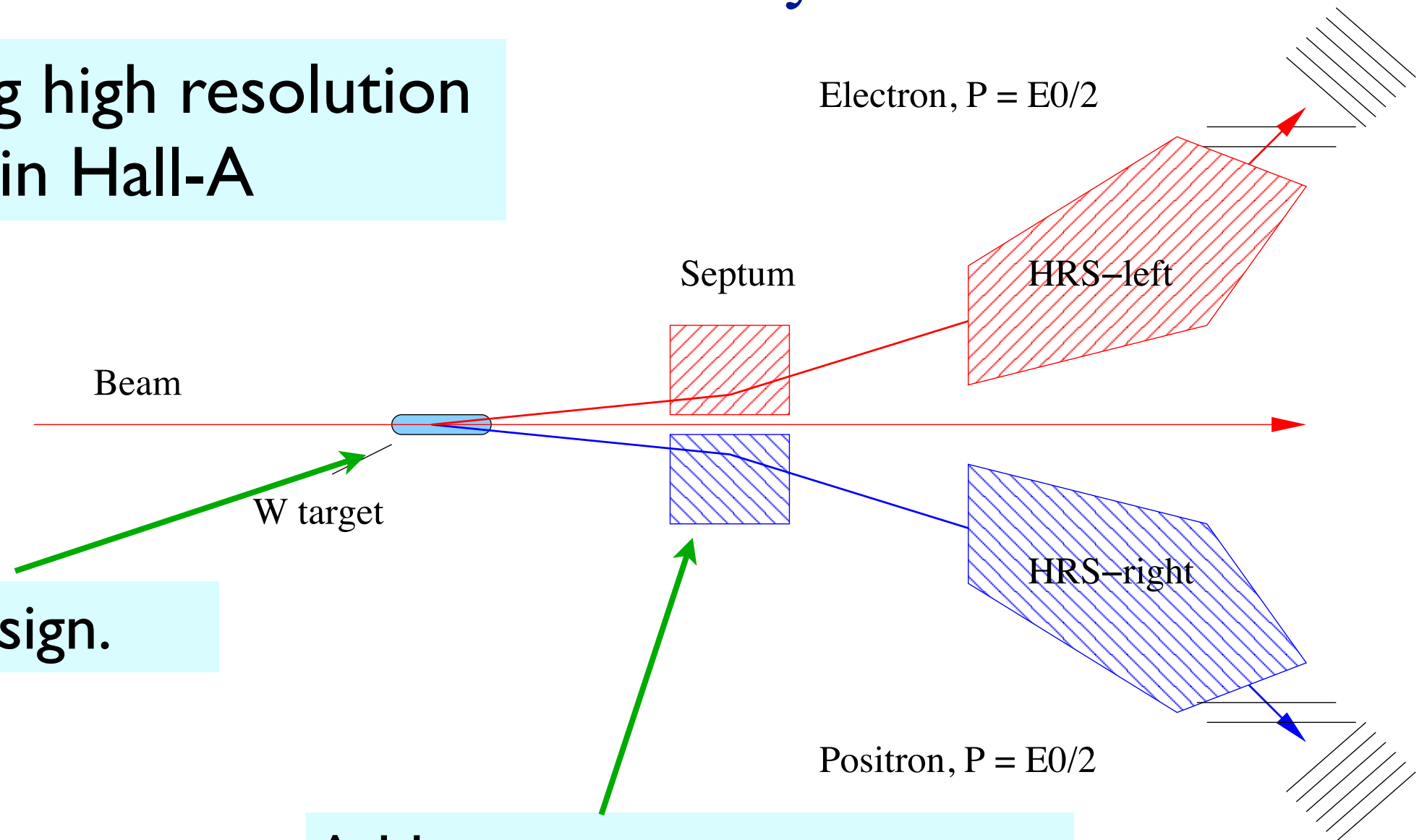

Add septum magnet system  
to get to smaller angles.

Detail are in:  
JHEP 1102:009,2011, [arxiv:1001.2557](https://arxiv.org/abs/1001.2557)

# Solution 1 - Spectrometers in Hall-A

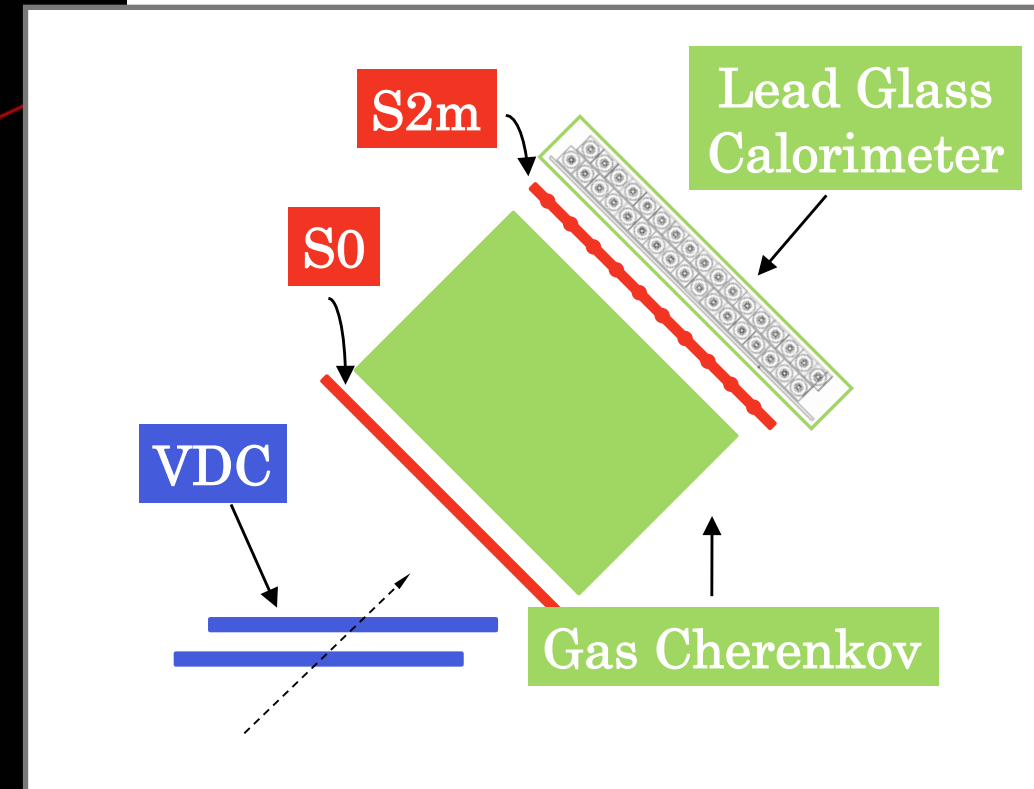
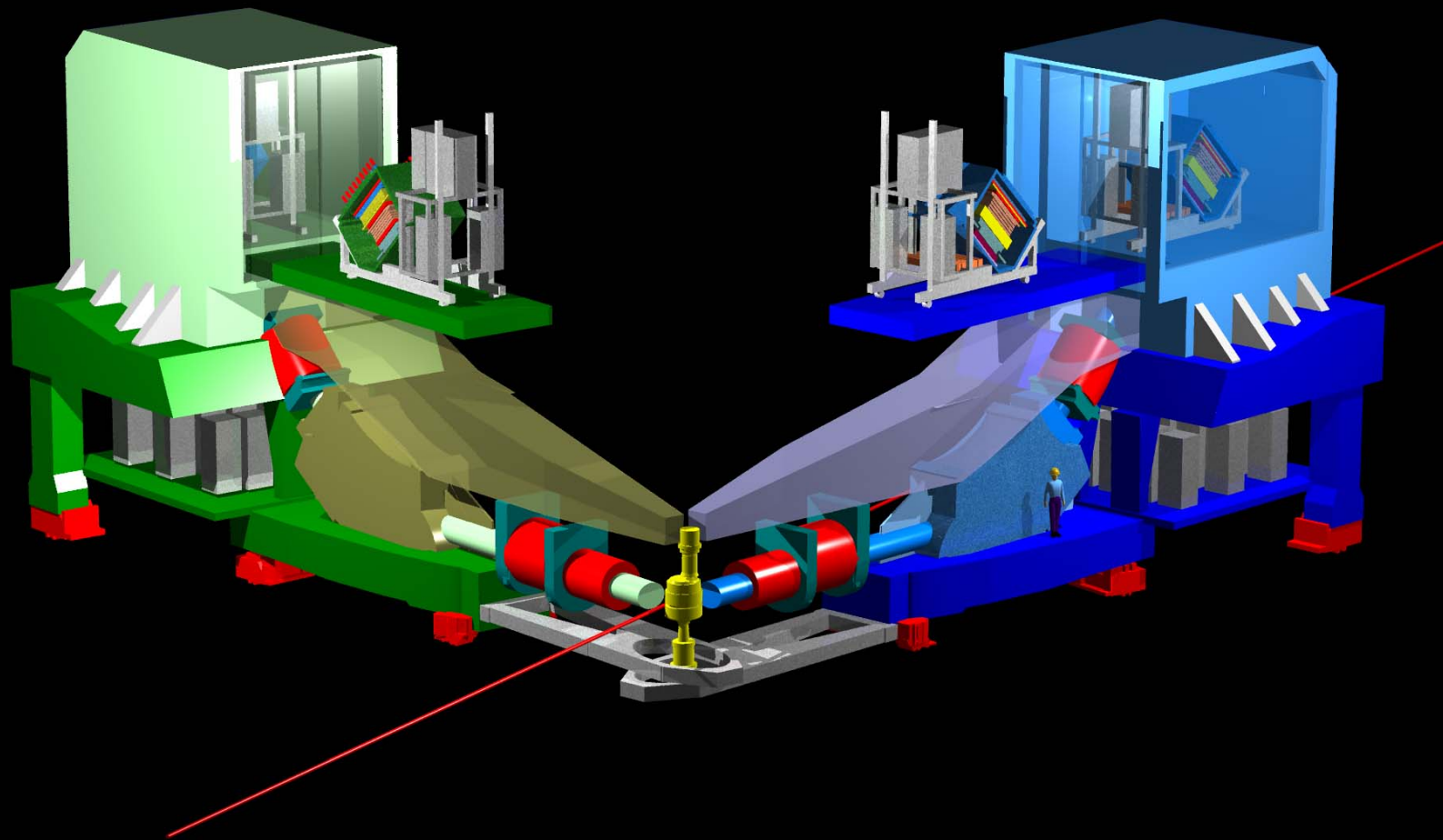

Range

Acceptance

Resolution

$0.3 < p < 4.0 \text{ GeV}/c$

$-4.5\% < \Delta p/p < 4.5\%$

$\delta p/p \leq 2 \cdot 10^{-4}$

$12.5^\circ < \theta_0 < 150^\circ$

6msr

$\delta\phi = 0.5 \text{ mrad (H)}$

$\delta\theta = 1 \text{ mrad (V)}$

( $\theta_0 = 5^\circ$  and 4.5 msr at with septum)



# High Luminosity

- To minimize occupancy in a forward detector:
  - \* Maximize accelerator duty cycle  
CEBAF has **100% duty cycle!**
  - \* Minimize detector response times: **Fast Detectors.**

$$\sigma(e^- + W \rightarrow W + A' + e^-)$$

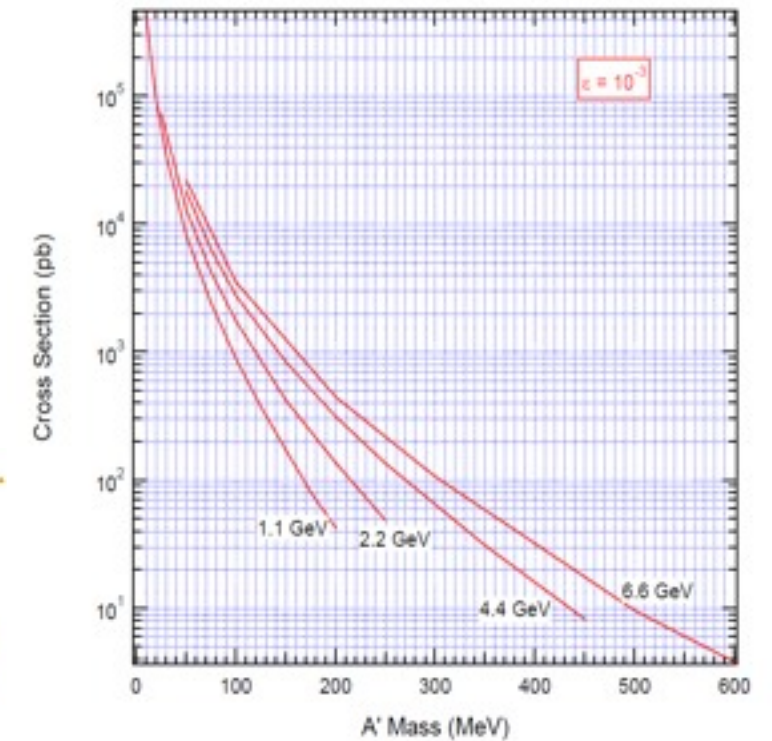

## CEBAF - Continuous Electron Beam Accelerator Facility

Simultaneous delivery of electron beam in three Halls. Can be at three different energies and intensities.

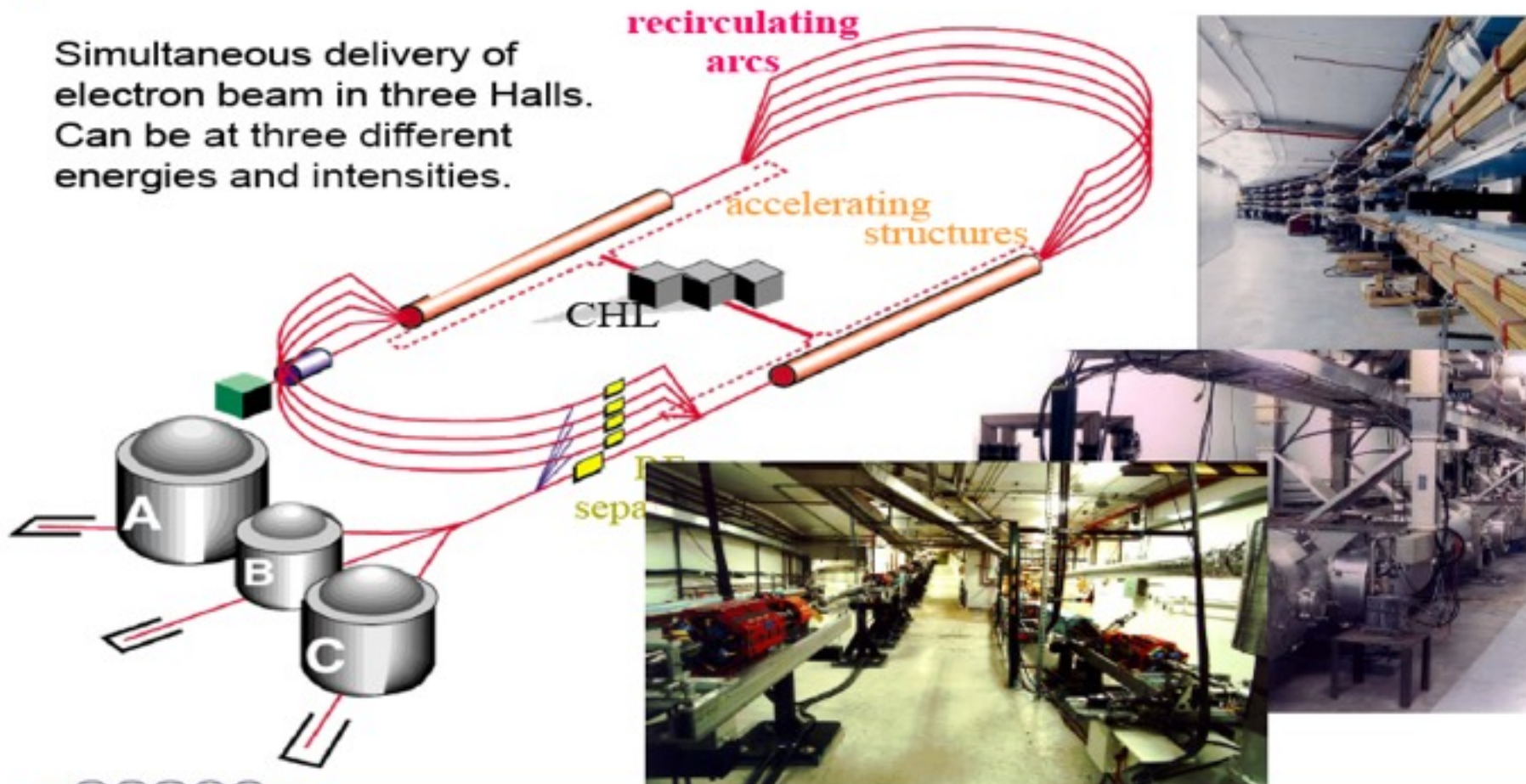

**Jefferson Lab: CEBAF**  
 E = 6 GeV (now) →  
 12 GeV (2014)  
 High currents ≤ 100 μA  
 Continuous! 500 MHz

# APEX test run

- Test run performed in Hall A, July 2010  
PRL 107:191804,2011, [arxiv:1108.2750](https://arxiv.org/abs/1108.2750)
- **Verified all key aspects of apparatus performance**
  - VDC tracking performance at 4–6 MHz singles rates
  - Gas Cerenkov detector in coincidence trigger to reject  $\pi^+$ 's
  - spectrometer optics & mass resolution
  - measurement of physics backgrounds
- Resonance search on 700K good trident events

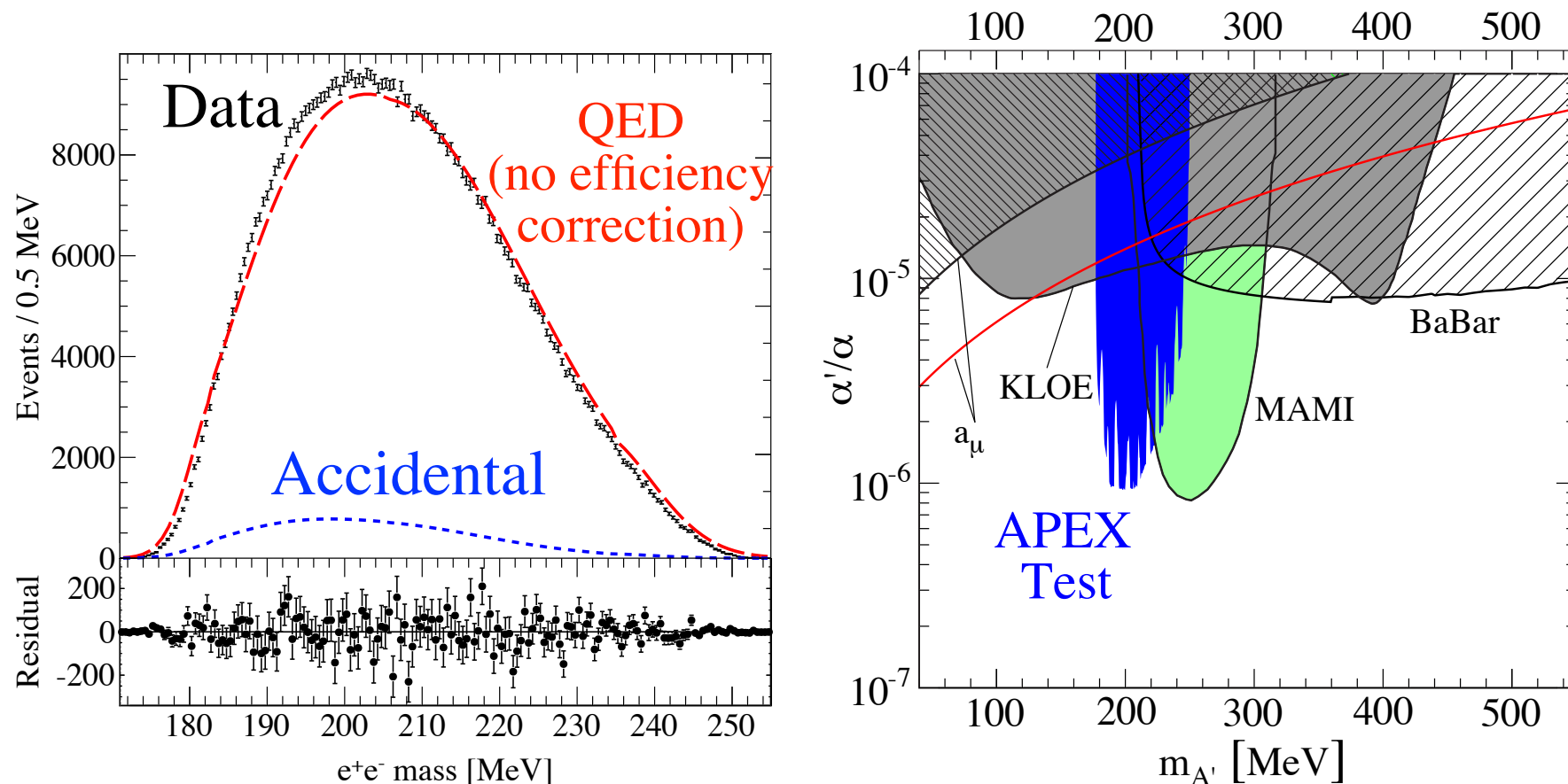



# Preparing for Full Run

---

- SciFi detector for optics calibration
  - design and production complete; first arm assembled and tested
- APEX extended target
  - target built for test run is at JLab
- Septum
  - design nearly finalized & vendor quotes obtained
- HRS detector maintenance is proceeding
- VDC electronics for high-rate data-taking

# Magnetic Spectrometer Optics

Measuring Contributions to the Mass Resolution  
(dominant: **angular resolution** + **mult. scatter**)

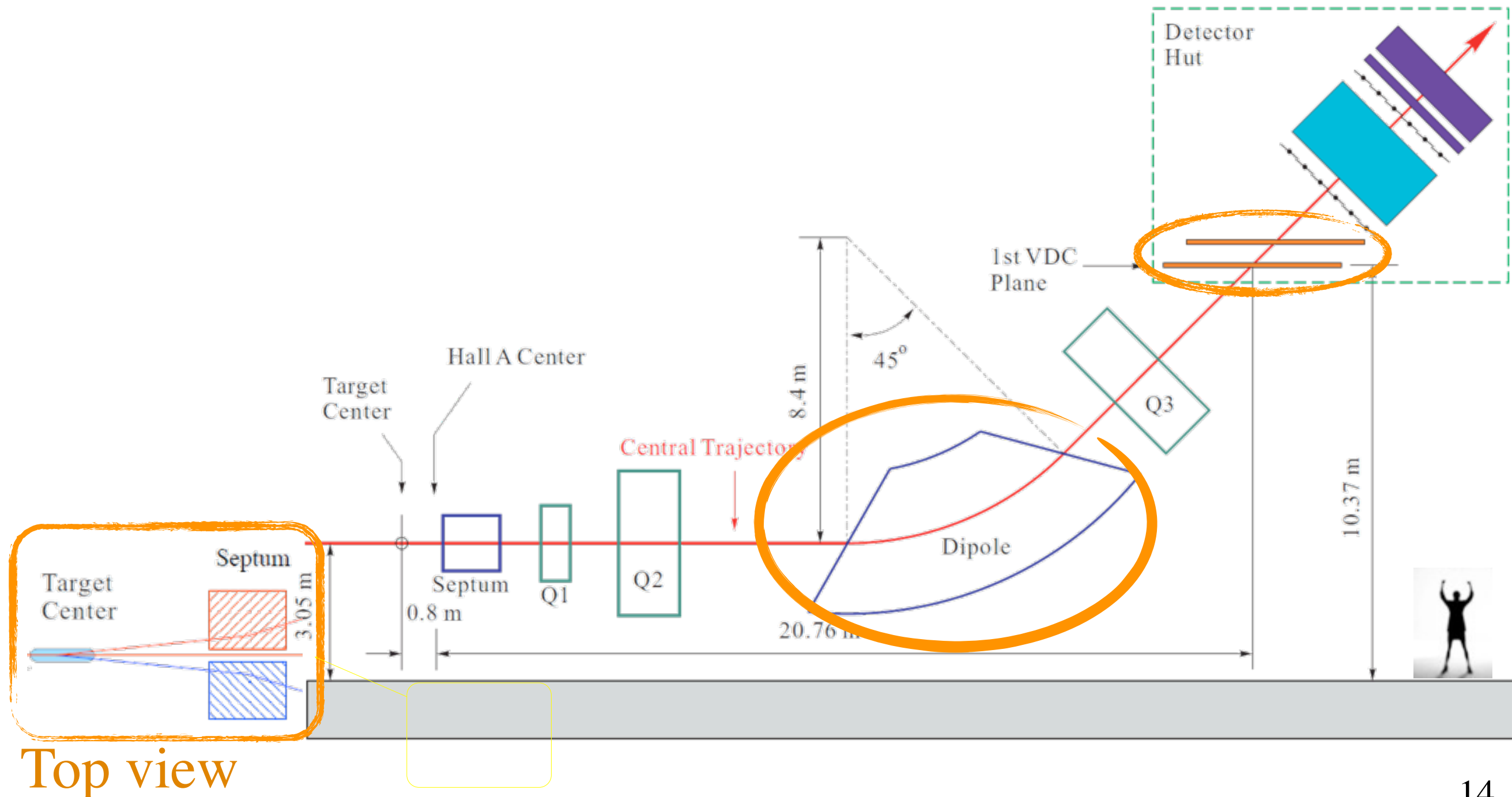

Top view



# Test Run Optics Calibration

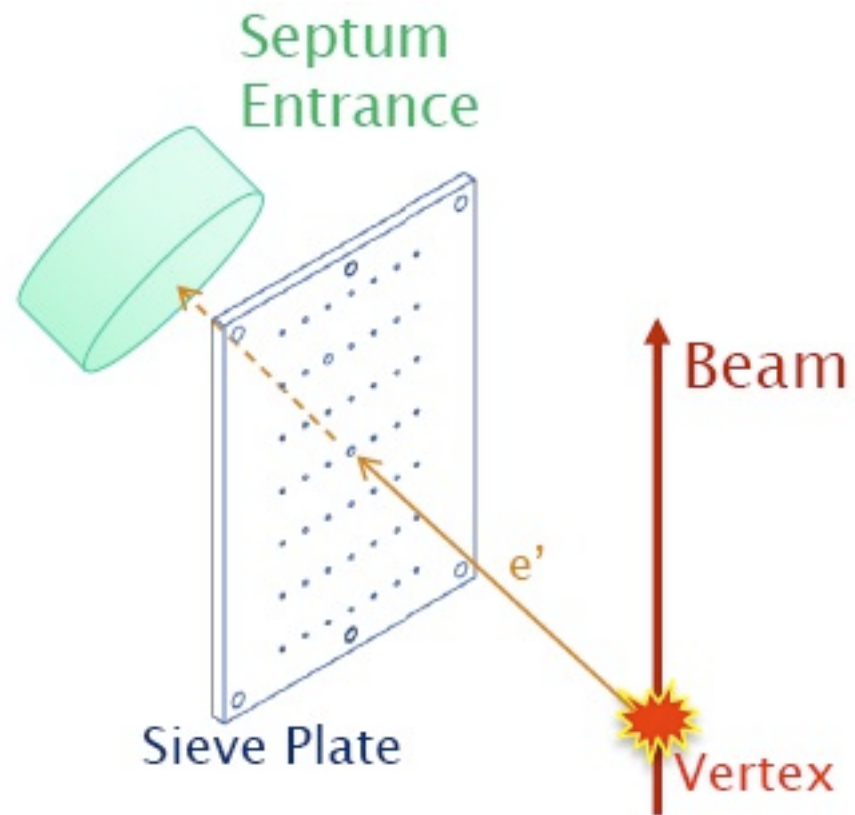

Removable sieve plate is inserted upstream of septum.

Use surveyed locations of sieve holes to calibrate magnetic optics.

Use reconstructed hole sizes to measure resolution.

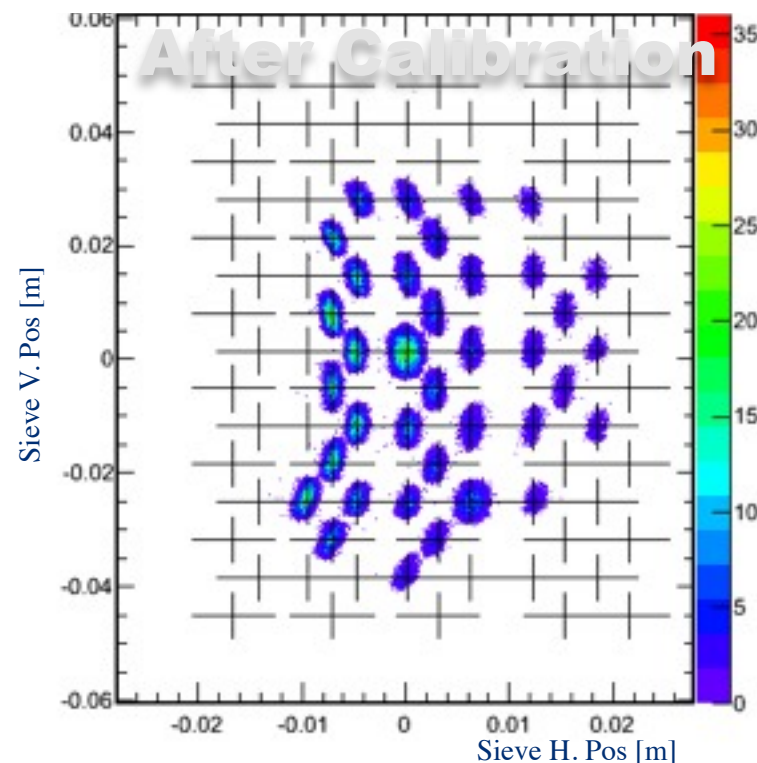
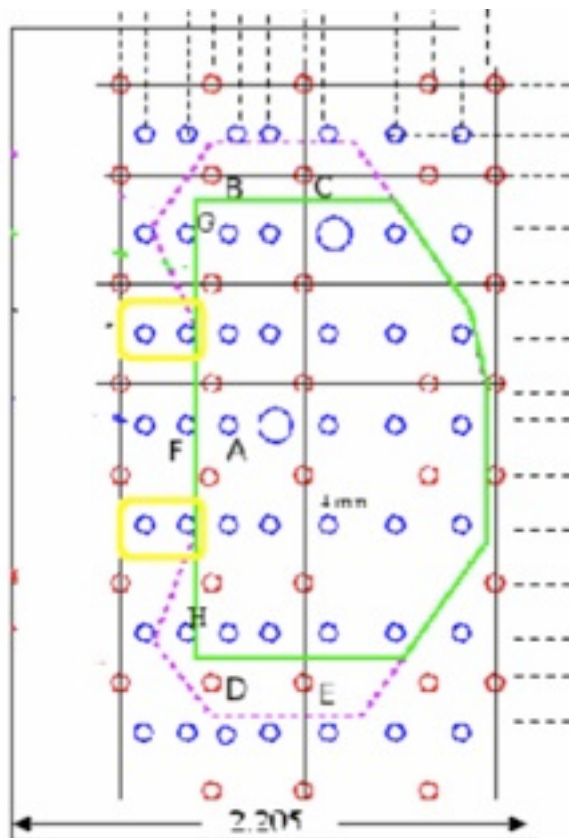

*...this method only works for negative polarity, and requires running at different beam energy.*

**Mass resolution  $\approx 1$  MeV  
 $\sim 0.5\%$**

# HRS optics

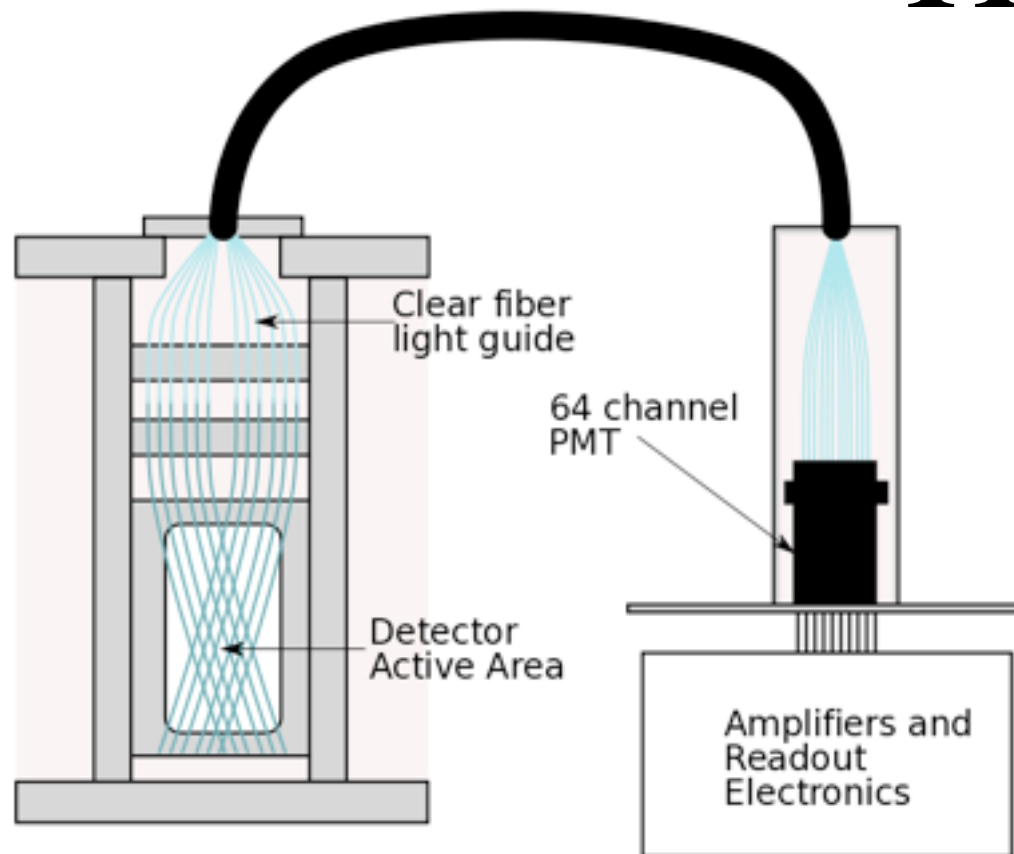

“Active sieve slit”: tagging by a Scintillating Fiber detector

- 1 mm fibers with 1/4” pitch  
(equivalent to 1024 sieve holes)
- Projected rate: 1-3 MHz per fiber
- Off-line time window < 5 ns
- Nearing completion

Allows optics calibration **at production beam energy & for both polarities**

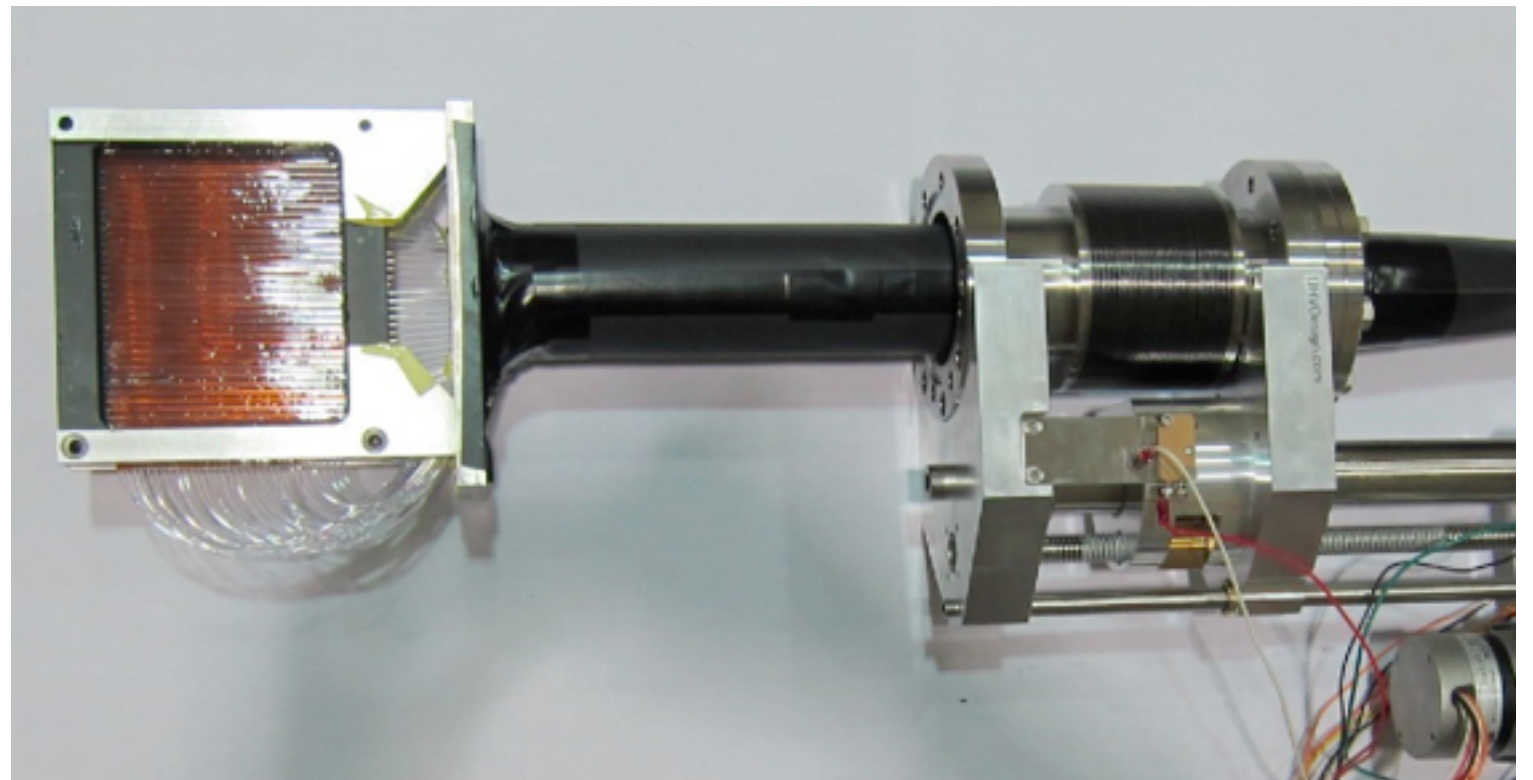
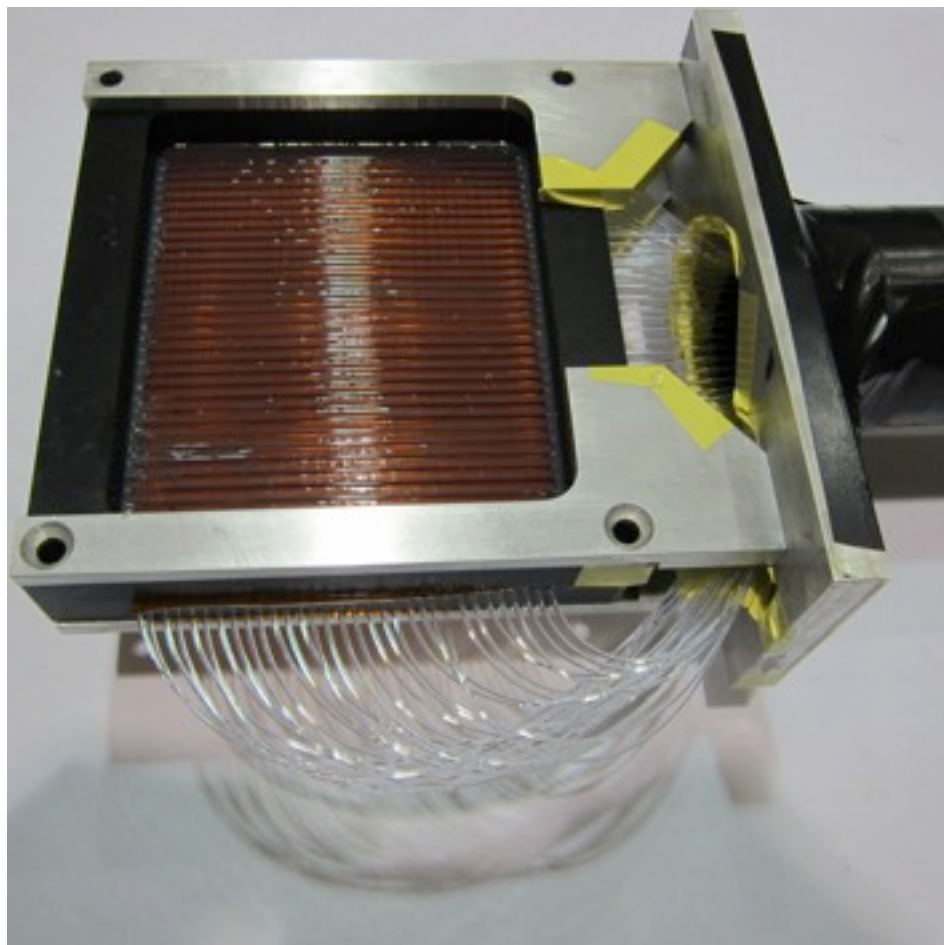



# Target Design: Minimizing Multiple Scattering

Target designed and built by SLAC APEX group for the test run (but not installed), currently at JLab.

Goals:

- $\sigma(\theta)_{\text{mult scat}} \leq 0.5 \text{ mrad}$   
 $\Rightarrow$  typical  $e^+e^-$  pair must only go through 0.3%  $X_0$  (2-pass)
- Target thickness 0.7–8%  $X_0$  (depending on  $E_{\text{beam}}$ )

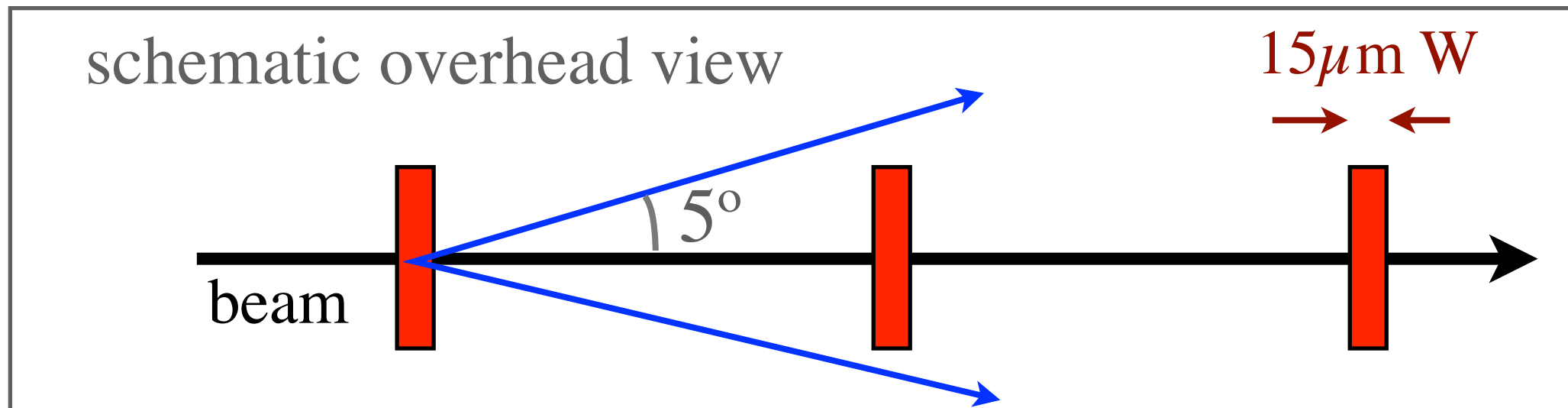

- High-Z target (reduce  $\pi$  yield for given QED rates)
- Stable under currents up to  $\sim 100 \mu\text{A}$

long target  $\Rightarrow$  wider single-run mass coverage

# Target Design: Minimizing Multiple Scattering

Target designed and built by SLAC APEX group for the test run (but not installed), currently at JLab.



# Target Design: Minimizing Multiple Scattering

Target designed and built by SLAC APEX group for the test run (but not installed), currently at JLab.

Goals:

- $\sigma(\theta)_{\text{mult scat}} \leq 0.5 \text{ mrad}$   
 $\Rightarrow$  typical  $e^+e^-$  pair must only go through 0.3%  $X_0$  (2-pass)
- Target thickness 0.7–8%  $X_0$  (depending on  $E_{\text{beam}}$ )

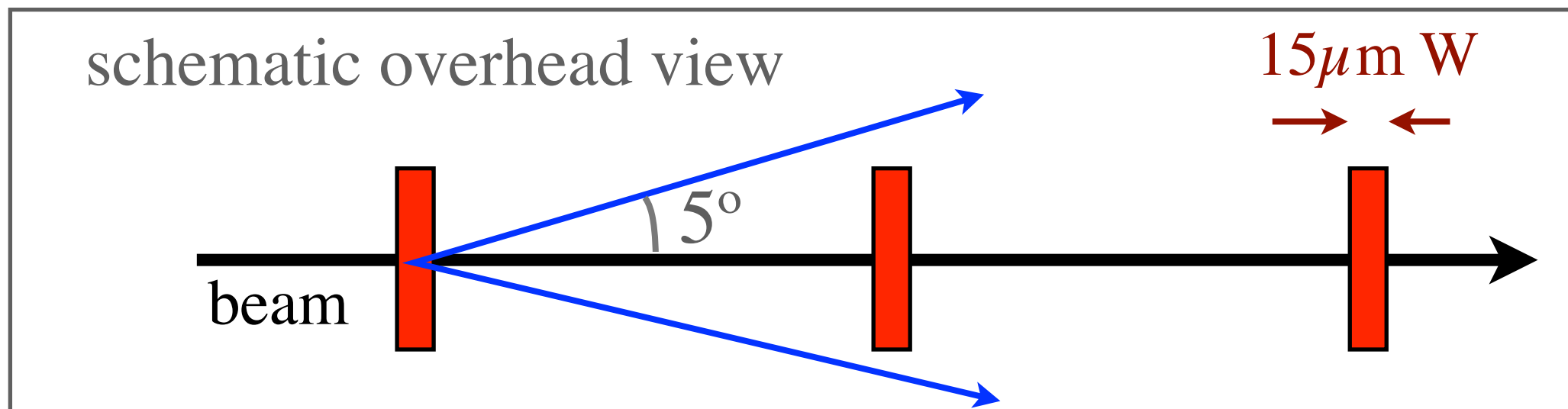

- High-Z target (reduce  $\pi$  yield for given QED rates)
- Stable under currents up to  $\sim 100 \mu\text{A}$

long target  $\Rightarrow$  wider single-run mass coverage

# Target Design: Minimizing Multiple Scattering

Target designed and built by SLAC APEX group for the test run (but not installed), currently at JLab.

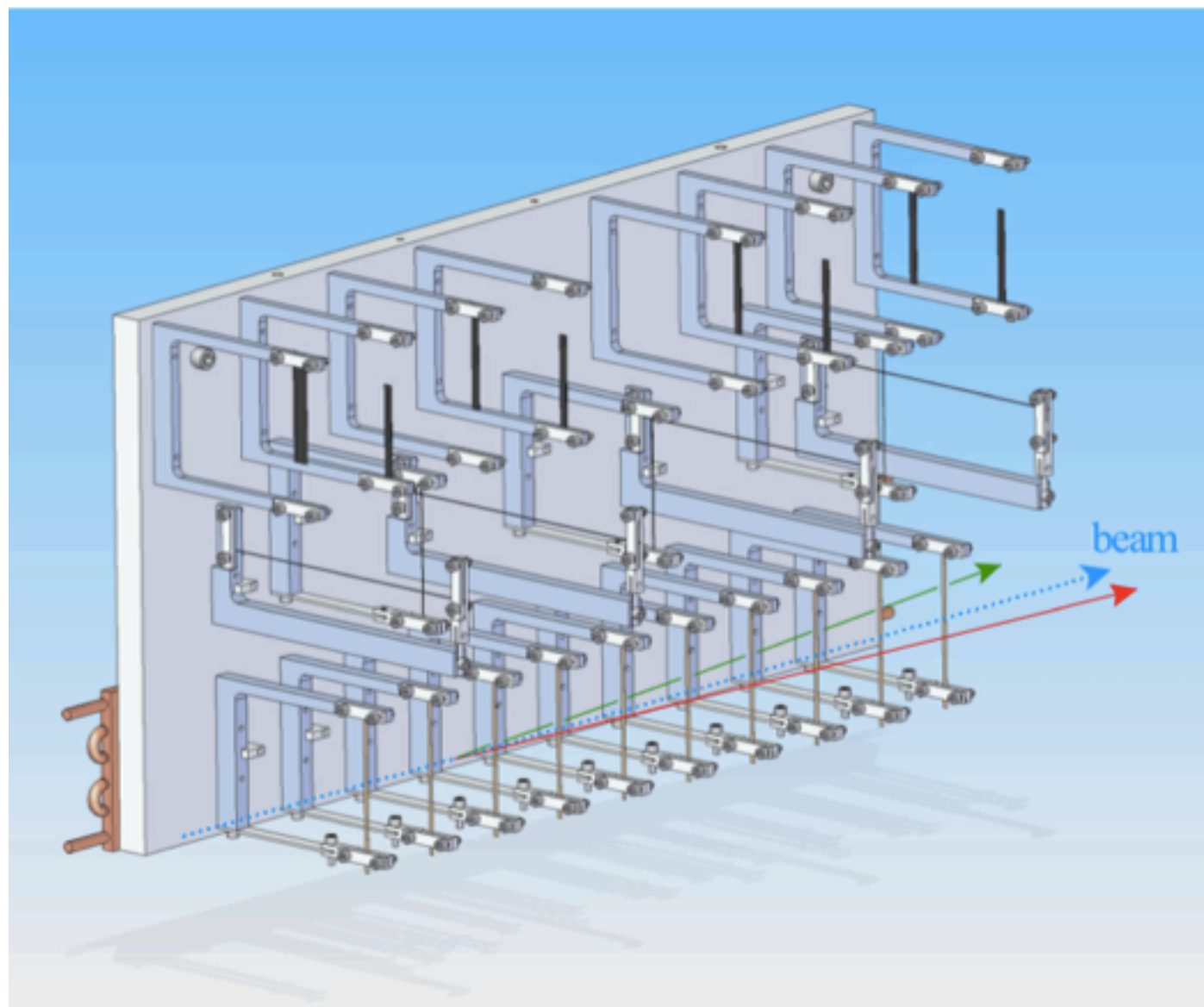



# New HRS Septum Magnet

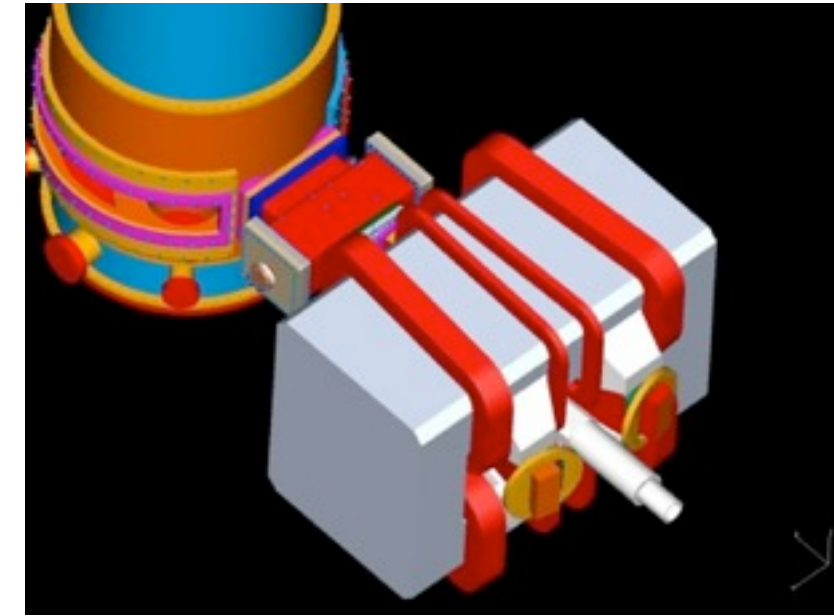
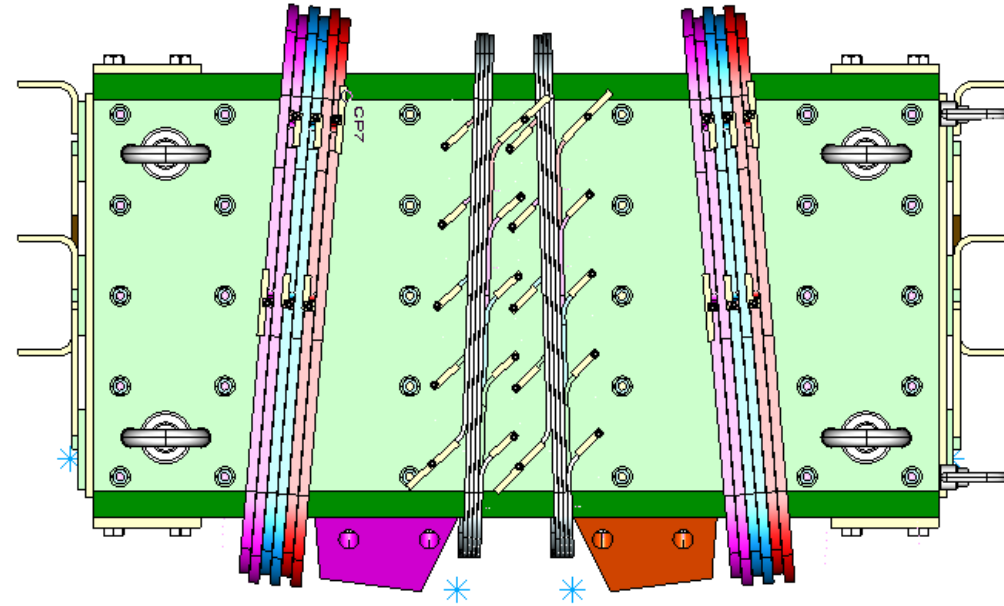
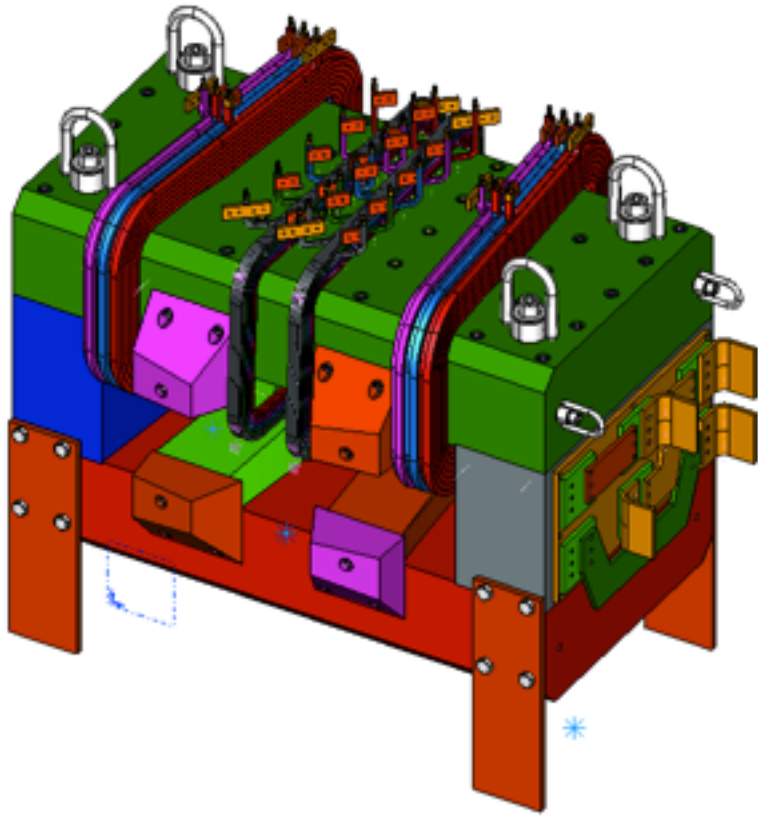

- Designed for parallel field capability  
(minimize fringe field near beamline)
- Optimized for full angular acceptance
- High density coils used to enable high-energy use

# Full APEX run plan and sensitivity

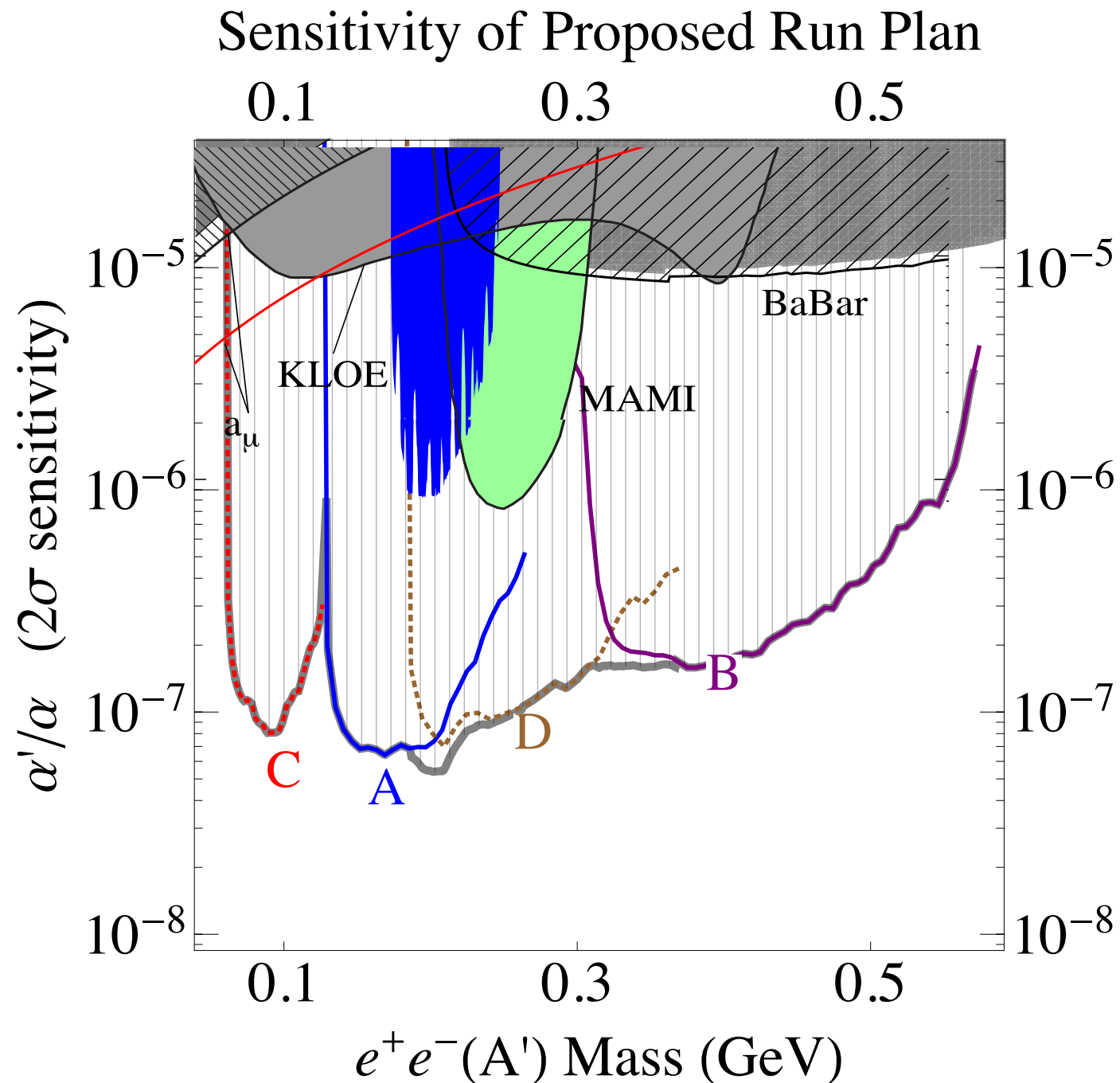

1 Month Beam Time  
– 6 days at 1,2,3 GeV  
– 12 days at 4.5 GeV)  
>100x test-run statistics

Approved by JLab PAC 37 with recommendation to run as soon as possible

Explores parameter space with **unparalleled efficiency** (particularly above  $\sim 300$  MeV)



# Solution 2: HPS

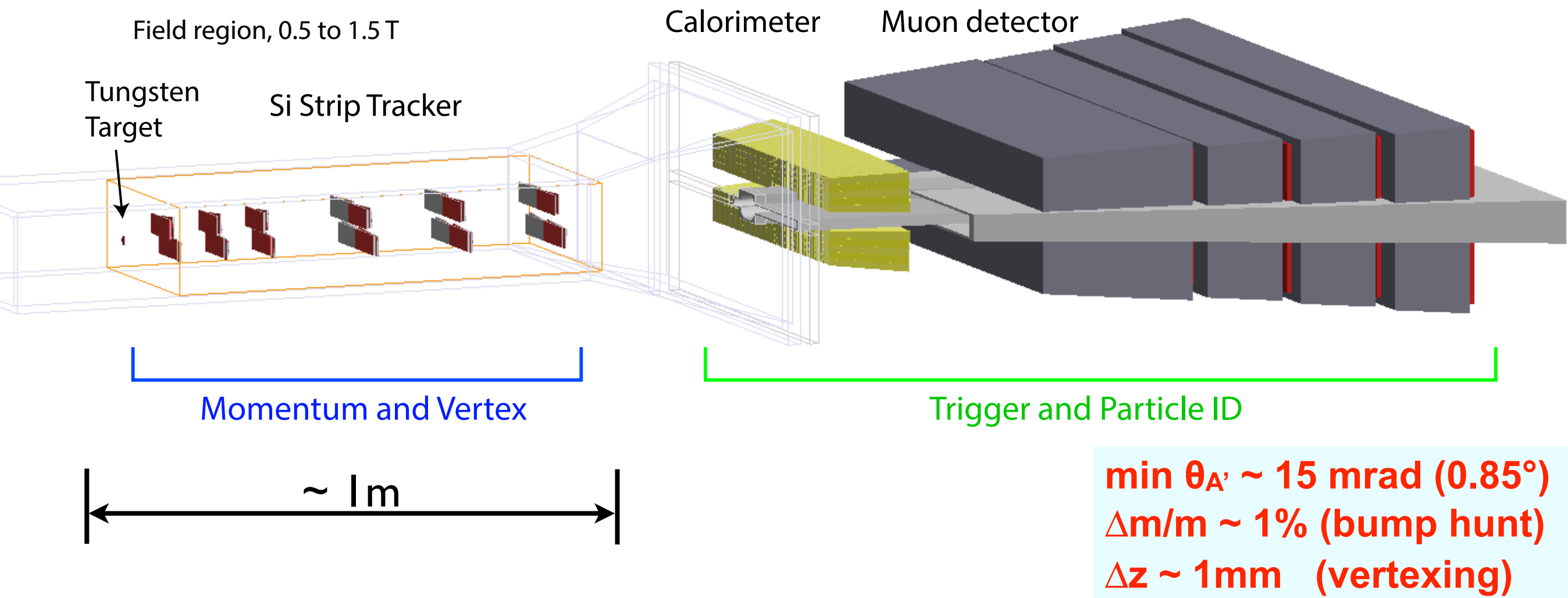

High rate, high acceptance, high mass & vertex resolution detector.  
“Table top” size.

Use Jefferson Lab  $e^-$  beam in Hall B.

Approved in 2012 with A rating & 180 days of beam time.

(condition: successful commissioning run with electron beam.)

Expected data taking: commissioning 2014, production 2015

# Beam Quality in Hall-B

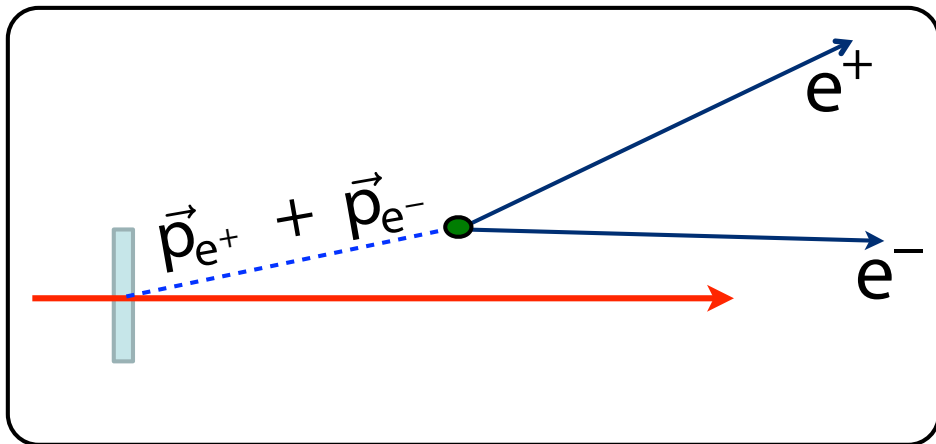

## Beam profile calculation

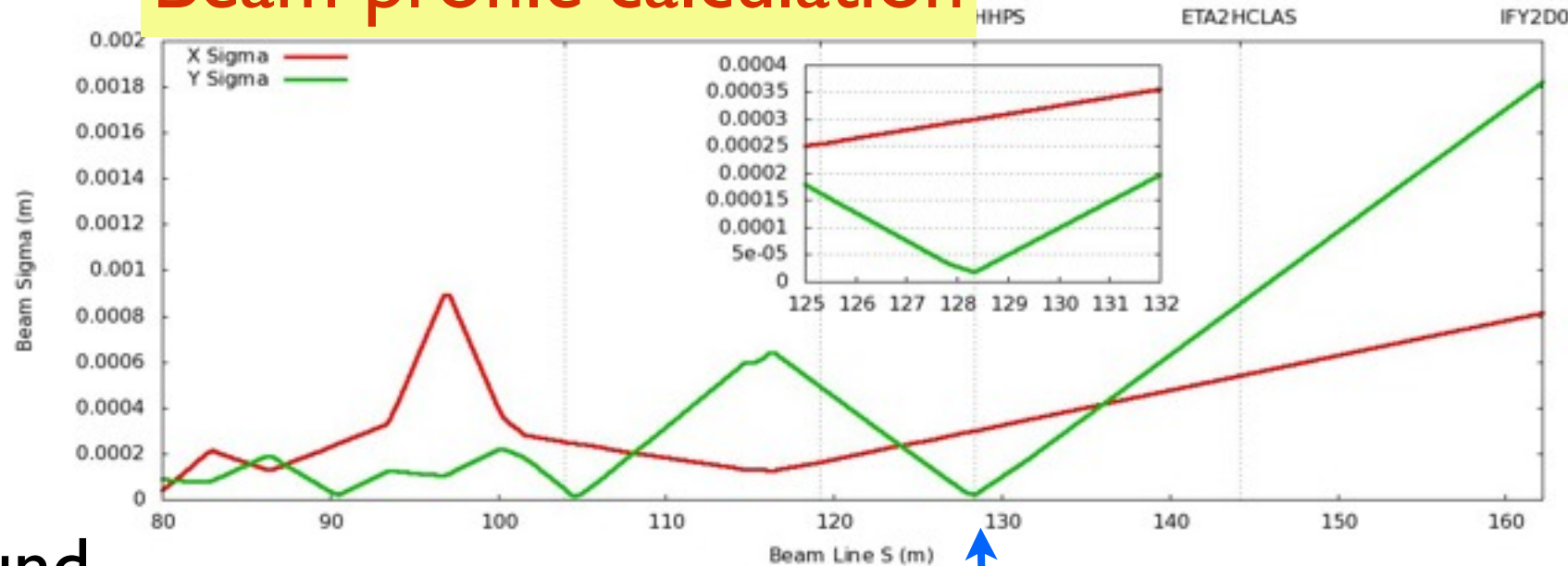

Target Location

Very low halo = low background

## Harp Scan x

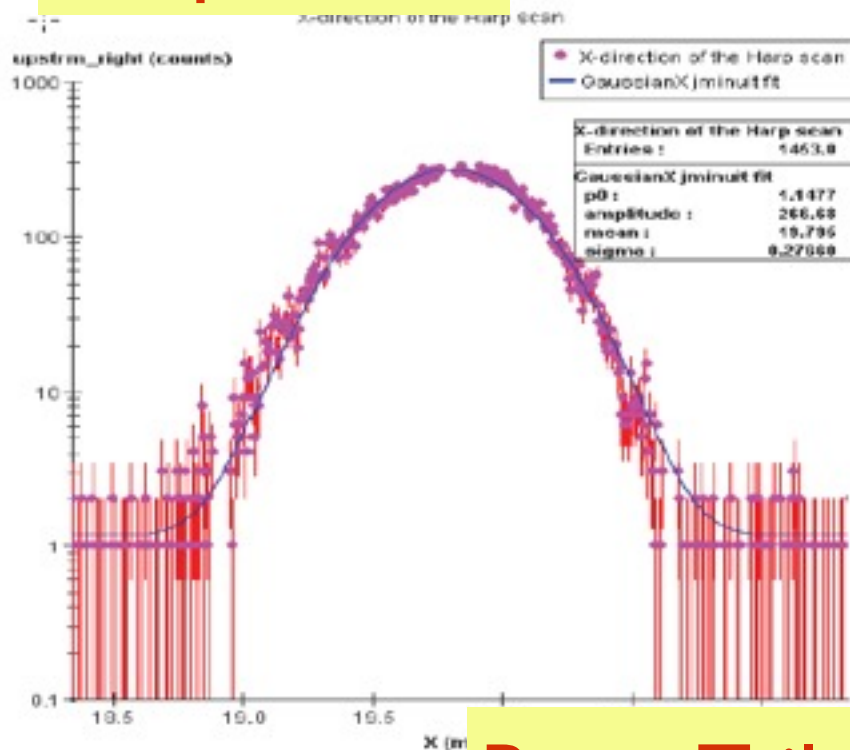

## Harp Scan y

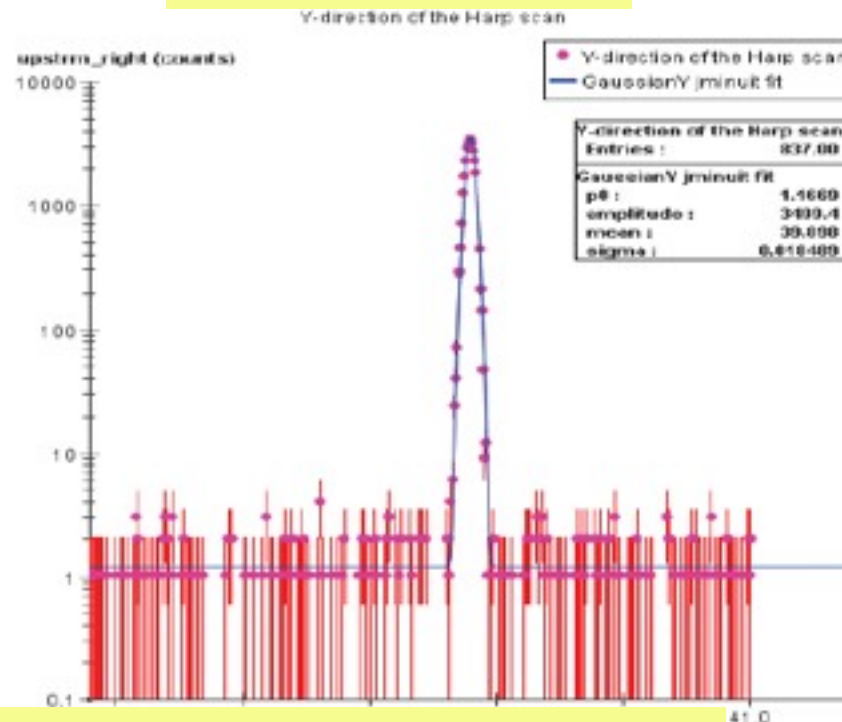

Wide beam spot in X to spread heat load. Tight beam spot in Y helps tracking & vertexing.

$I_{\text{beam}} = 1 \text{ to } 500 \text{ nA}$

Beam Tail  $< 10^{-5}$ ,  $\sigma_Y \sim 18 \mu\text{m}$



# Controlling beam background

- Silicon sensors and EM Cal must be positioned as close to the beam as possible to maximize low mass acceptance. Backgrounds matter!
- **Design constraints**
  - \* Avoid Multiple Coulomb Scattered (MCS) beam
  - \* Avoid photons radiated in target
  - \* Avoid “sheet of flame”, the beam electrons which have radiated, lost energy, and been deflected
  - \* Avoid beam gas interactions.
- HPS splits detectors to avoid the “Dead Zone”, and puts SVT in vacuum.

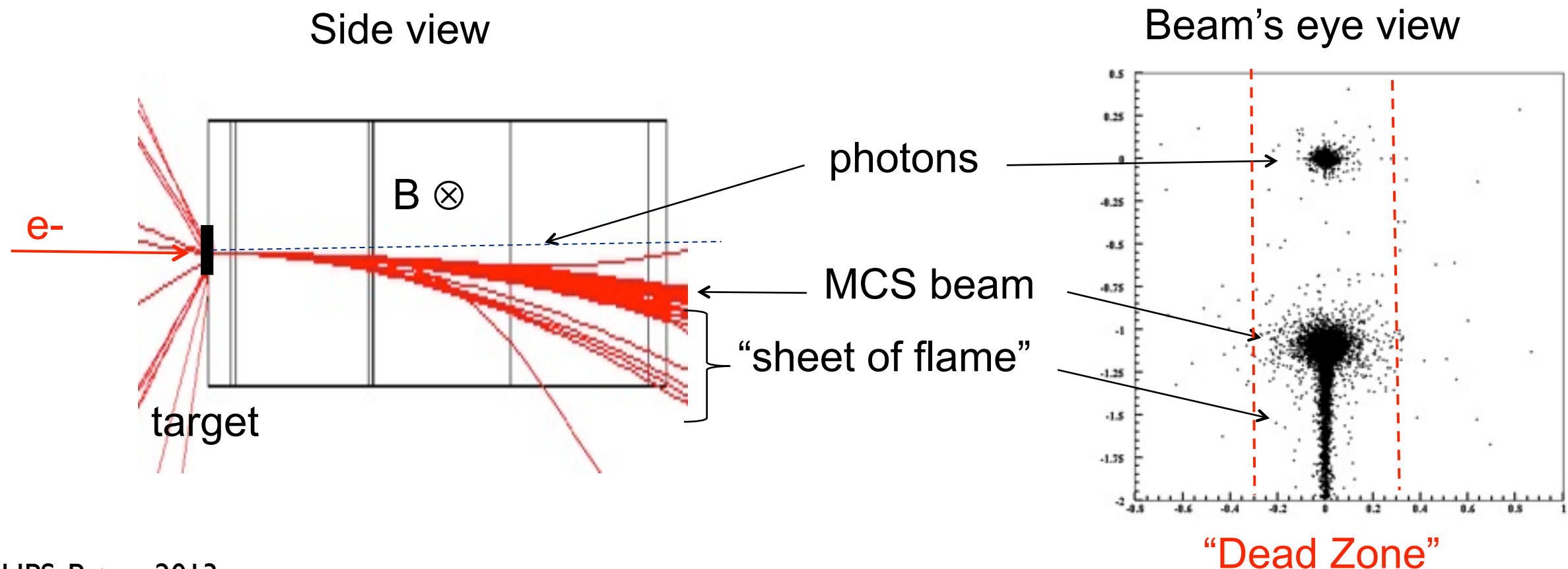

# Split Design

- Both the Silicon Vertex Tracker (SVT) and the Ecal are split vertically, to avoid the “sheet of flame”.

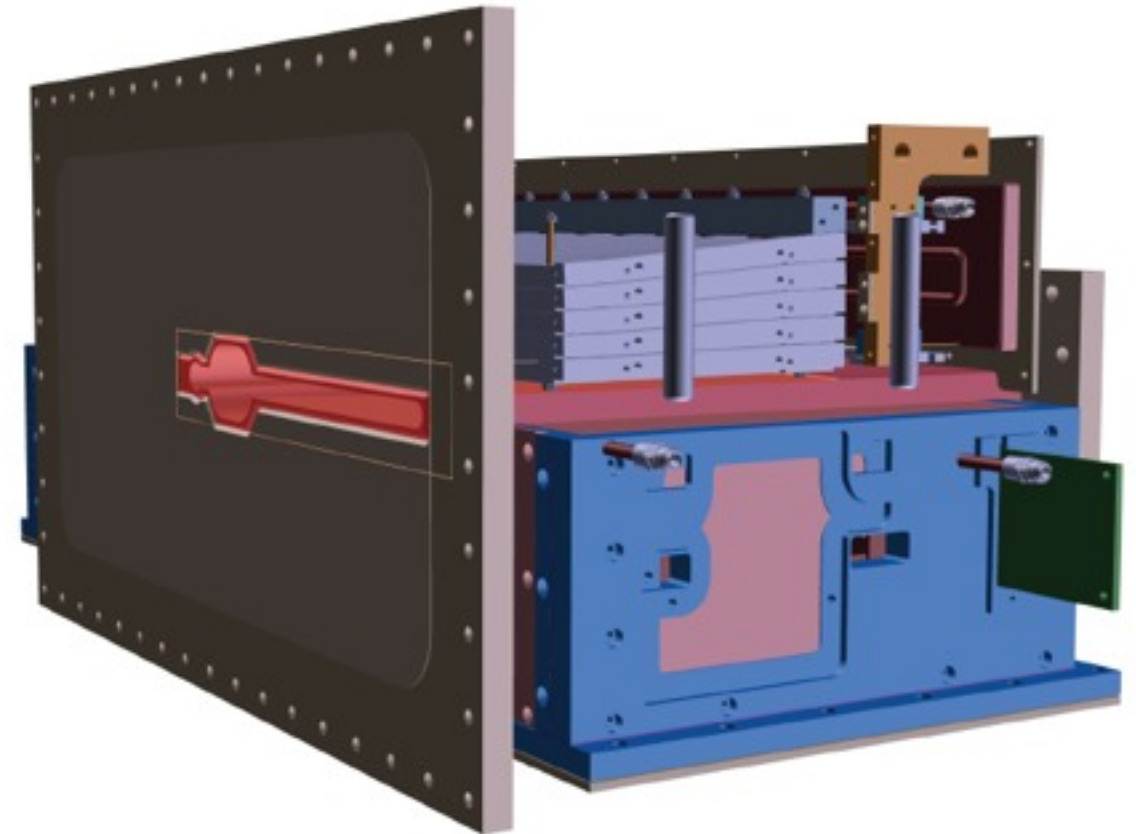
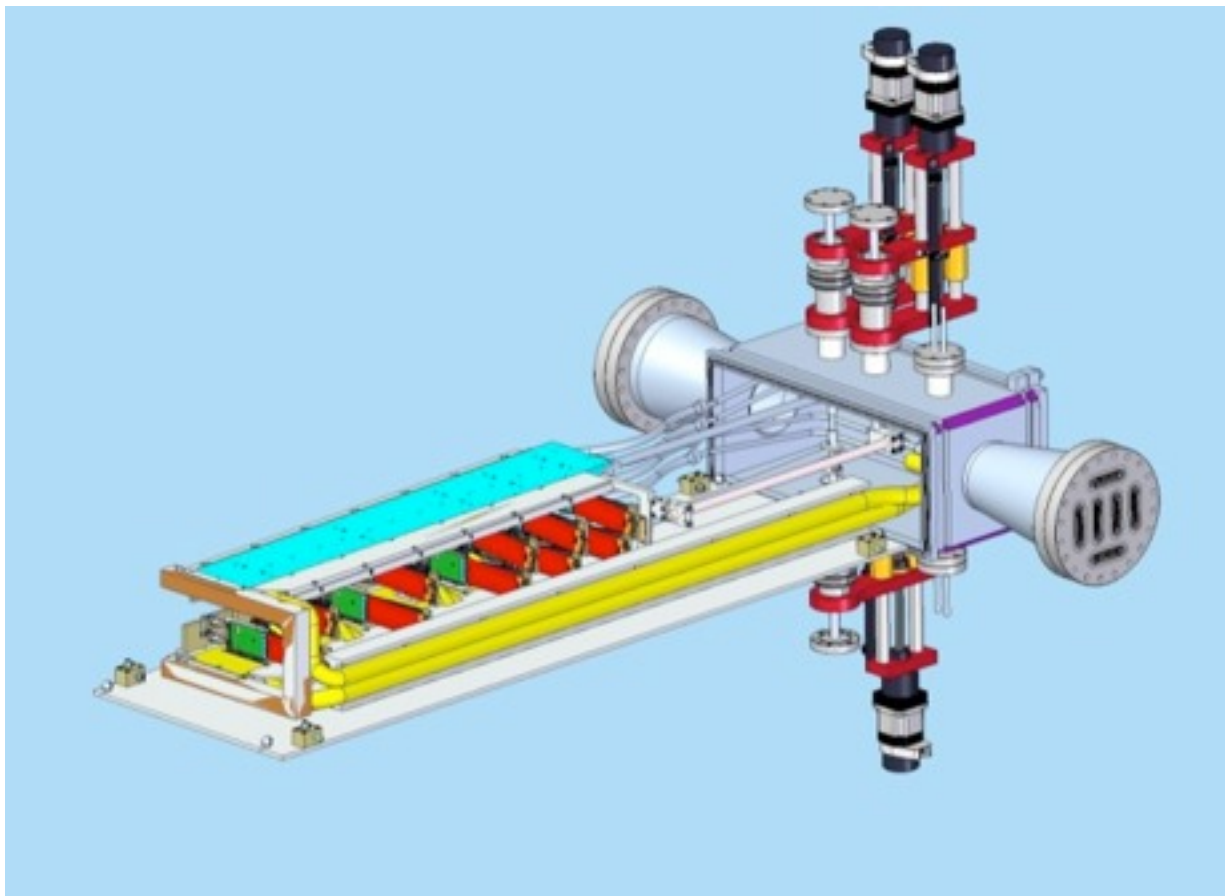

- The first layer of the SVT comes within 0.5 mm of the beam to allow acceptance at 15 mrad, so precision movers, working in vacuum, are needed to position it accurately w.r.t. the beam
- The beam passes between the upper and lower halves of the Ecal through the Ecal vacuum chamber, which accommodates the photons radiated at the target, the multiple scattered electron beam, and the “sheet of flame”.



# Silicon Vertex Tracker

- **Si microstrip sensors readout by CMS APV25's**  
40 MHz readout  
 $\sigma_x \approx 6 \mu\text{m}$ ;  $\sigma_t \approx 2\text{-}3 \text{ ns}$
- **Tracker has 6 layers, each axial + stereo**  
1st layer is 0.5 mm from beam.  
Measures track momentum and trajectory  
Placed inside Hall B pair spectrometer magnet  
Resides in vacuum to minimize beam backgrounds  
Split top and bottom to avoid beam and “wall of flame”

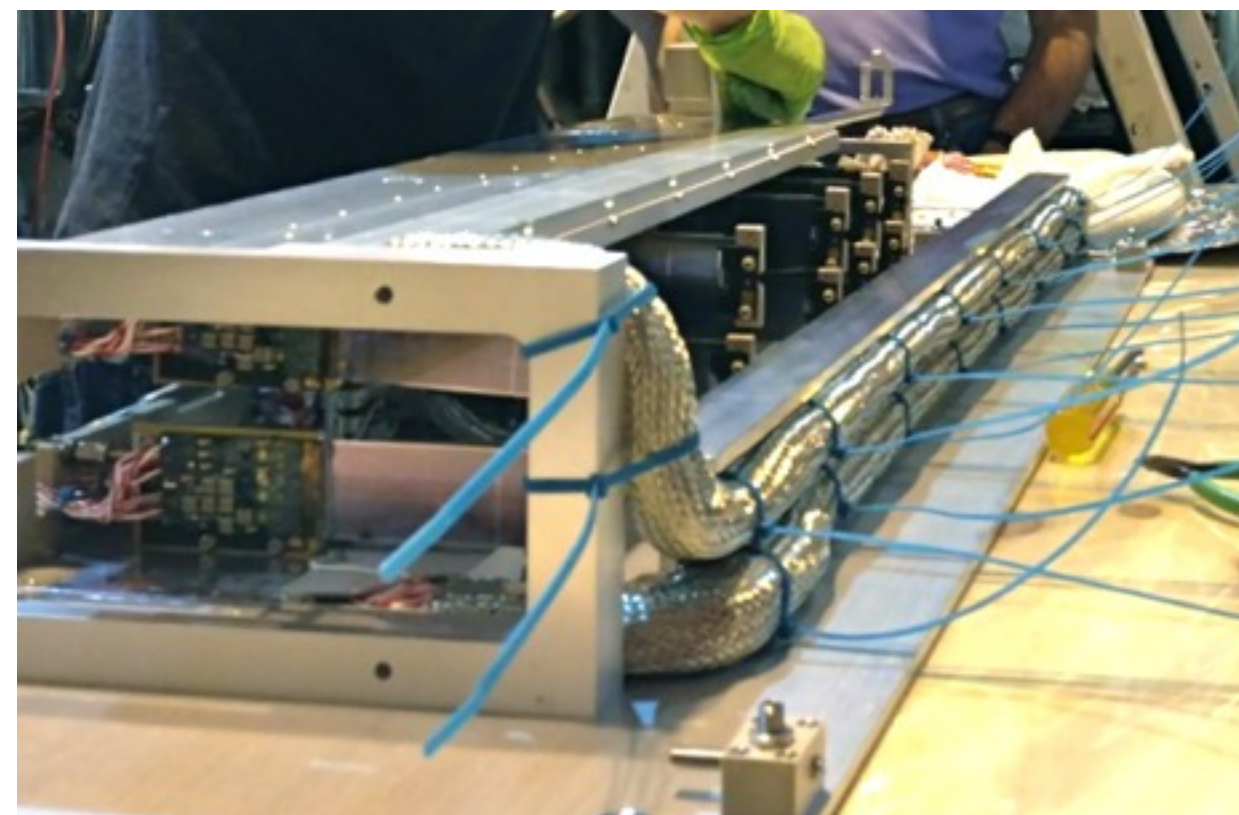
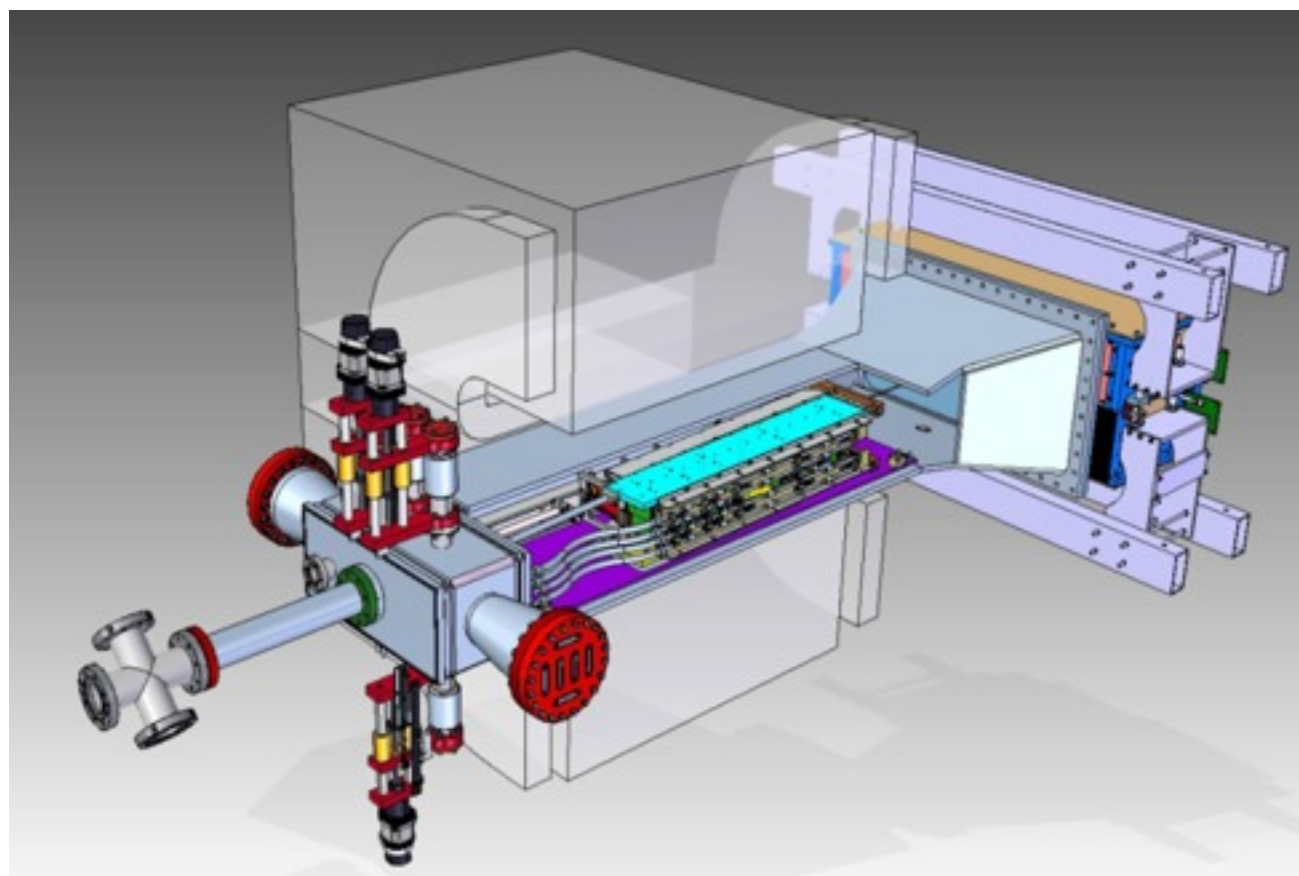
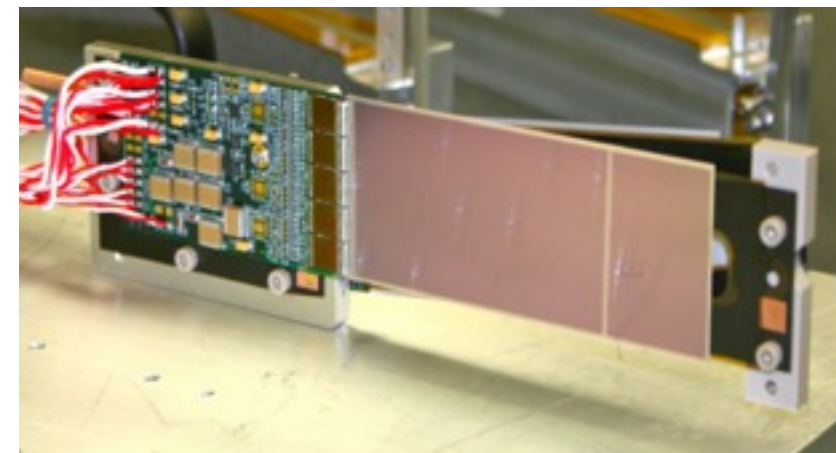



# Acceptance

- \* At small  $A'$  mass, dead zone limits acceptance
- \* At large  $A'$  mass, limited by size of layers 5,6 (magnet)
- \* Increased z-vertex displacement increases dead zone



MC radiated events @ 2.2 GeV

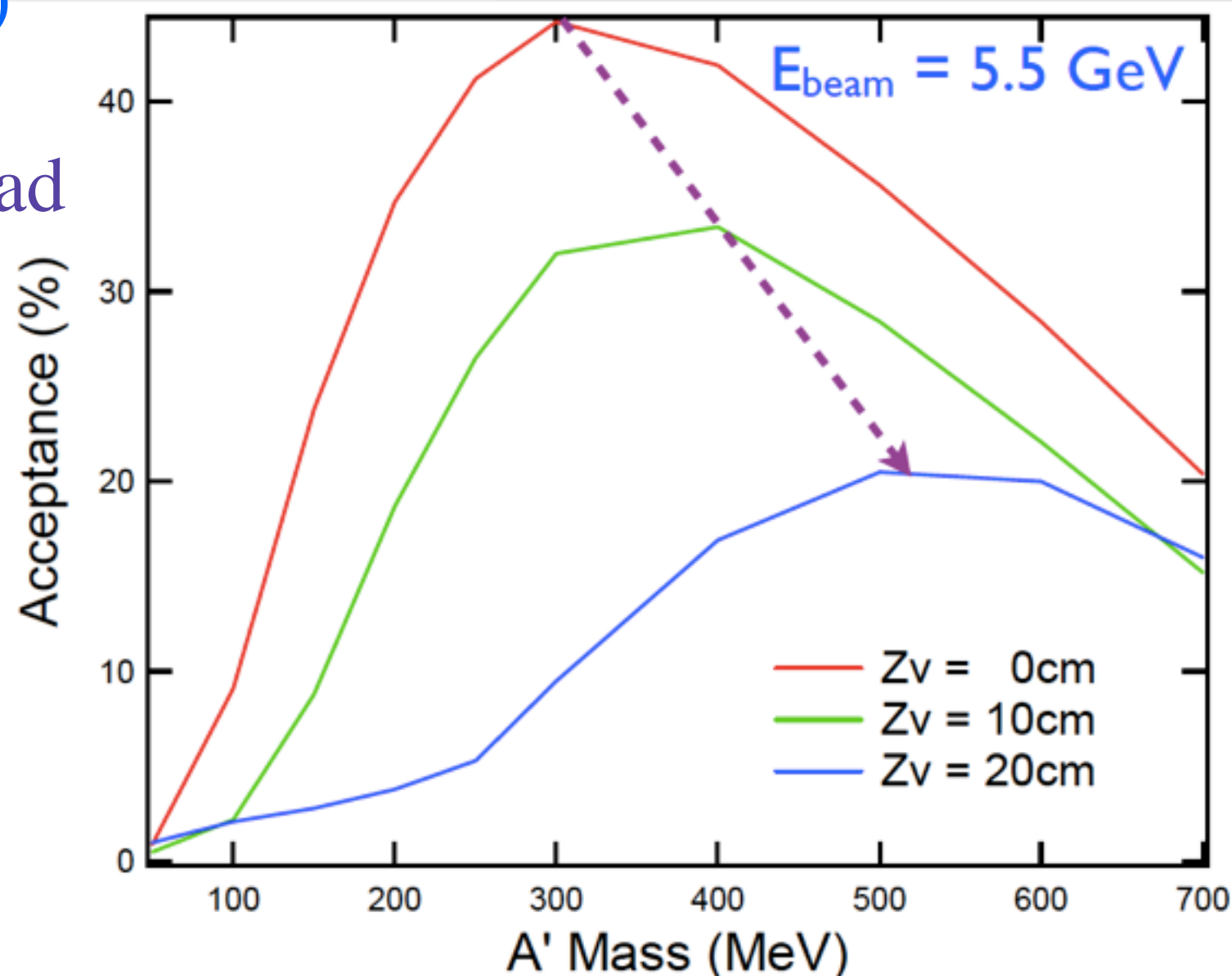
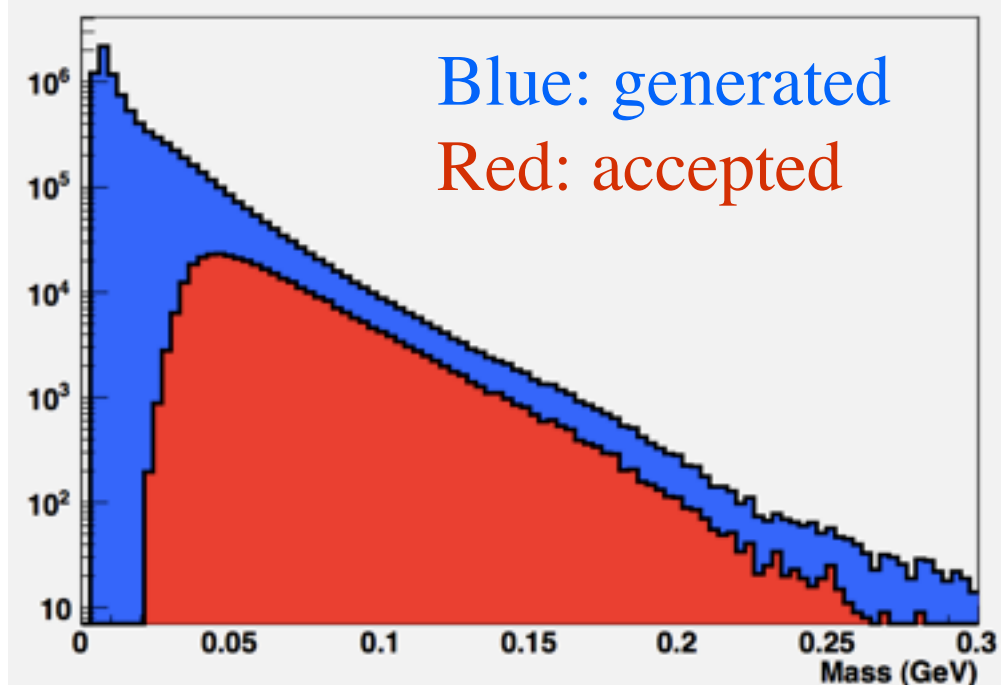



# Electromagnetic Calorimeter

- Ecal consists of top and bottom modules, each arranged in 5 layers , with 442 lead-tungstate ( $\text{PbWO}_4$ ) crystals in all.
- Crystals are readout with APDs and preamplifier boards
- Data is recorded in 250 MHz JLAB FADC250
- Thermal enclosure holds temperature constant to  $\sim 1^\circ \text{F}$  to stabilize gains

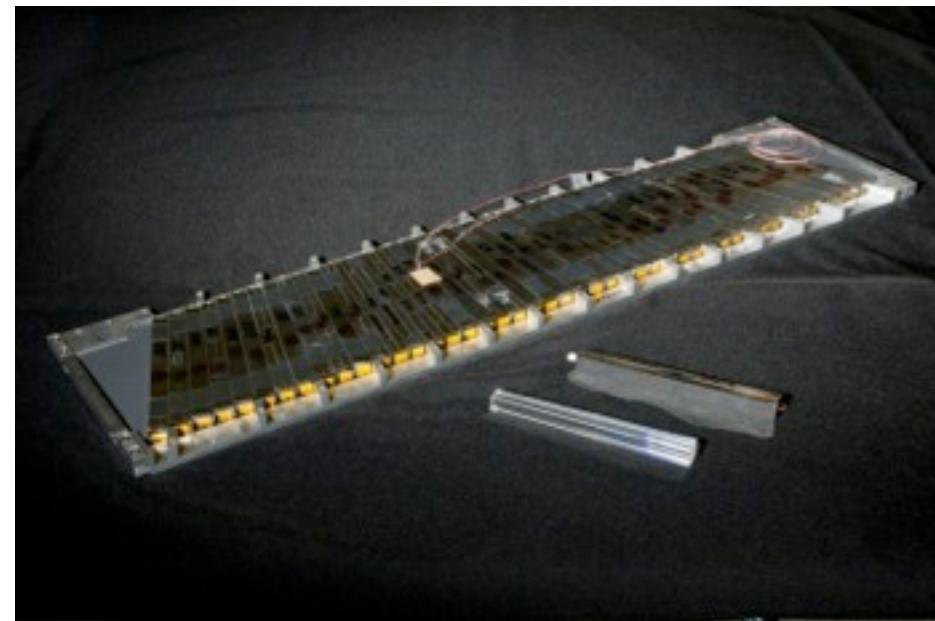
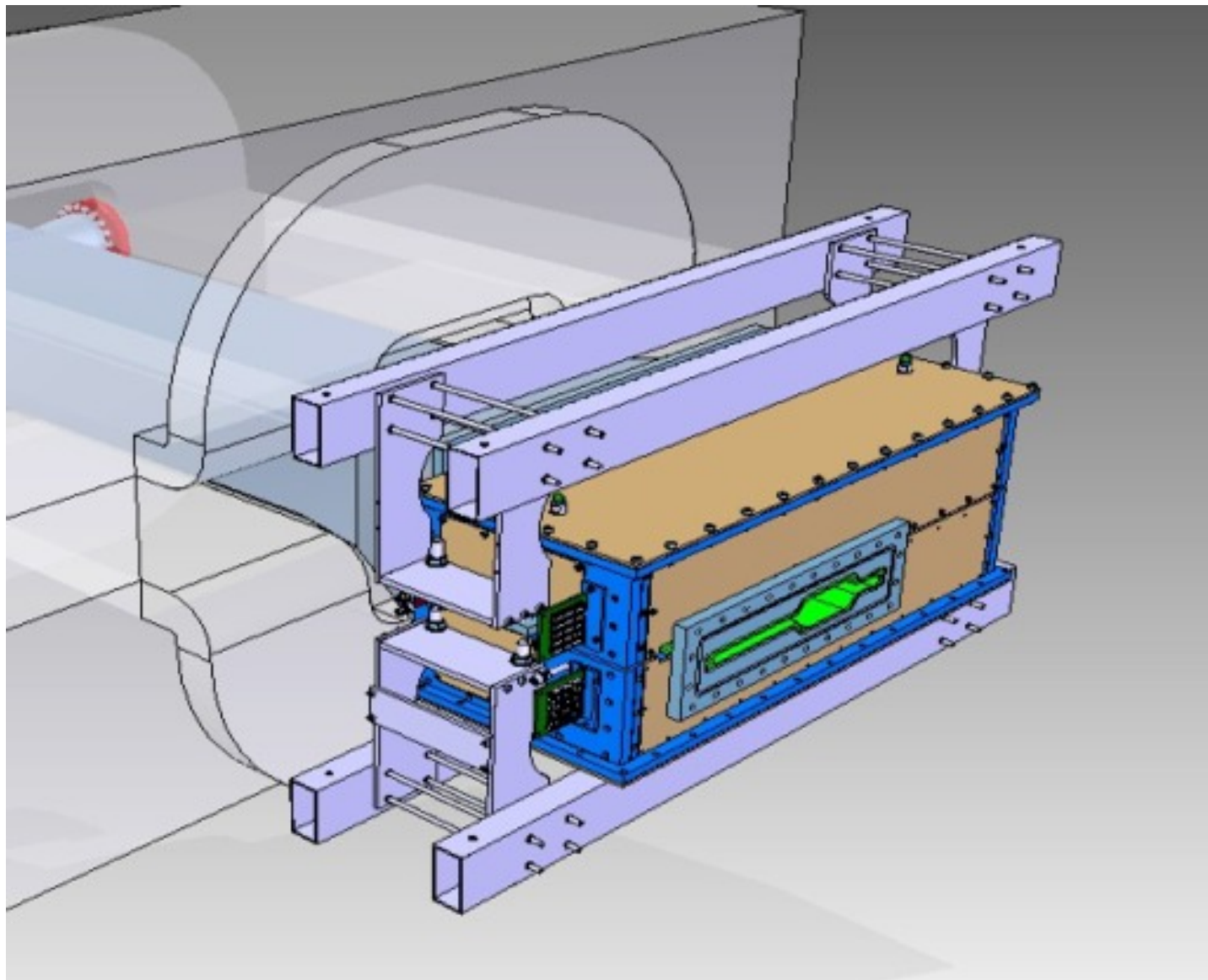



# Simulated Trigger Rate.

- Full GEANT4 simulation of detector, with EGS5 input events.
- Event pile-up and Ecal pulse width effects have been added to the GEANT4 simulation of the HPS trigger.

Simulated Test Run ECal

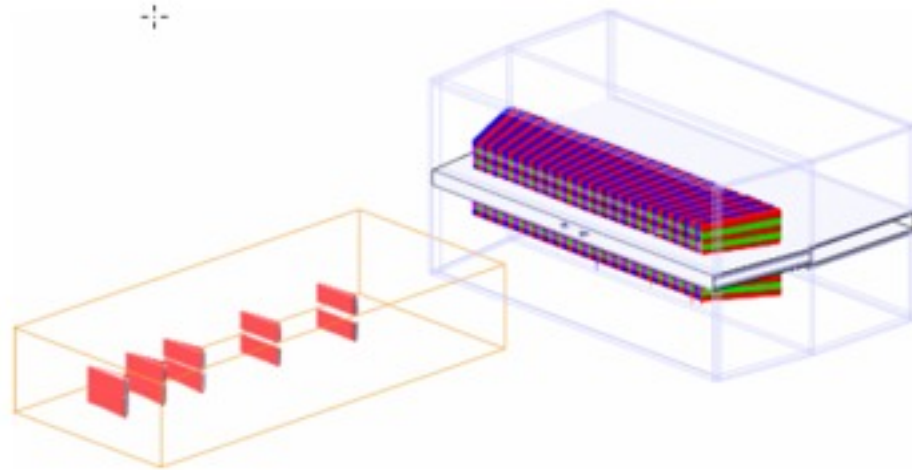

Full time development of Ecal Pulses included

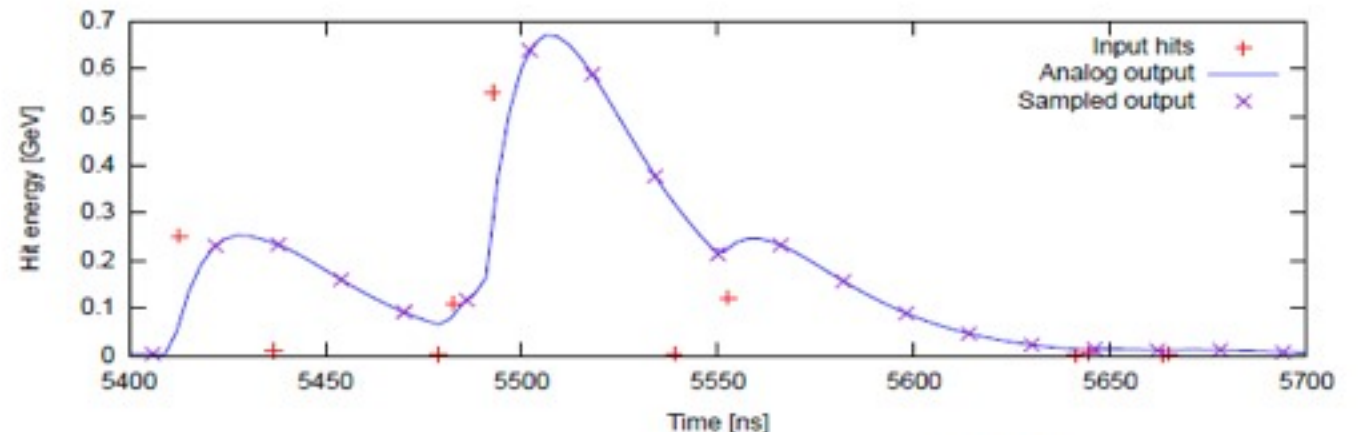

- **Performance at 2.2 GeV (200 nA)**

\*35 kHz trigger rate, compatible with previous estimate

\* 1% of useful events are affected by pileup

- **HPS trigger rates under control**

Trigger cut	75 MeV/c <sup>2</sup> A' acceptance	Background rate
Pairs of clusters in opposite quadrants	59.5%	1.8 MHz
Cluster energy between 100 MeV and 1.85 GeV	45.1%	725 kHz
Energy sum less than $E_{beam}$	45.1%	431 kHz
Energy difference less than 1.5 GeV	45.1%	386 kHz
Energy-distance cut	36.1%	80 kHz
Clusters coplanar to within 35°	35.3%	46 kHz
Not counting double triggers	34.4%	43.8 kHz
Applying trigger dead time	18.8%	34.8 kHz



# Muon Detector Design

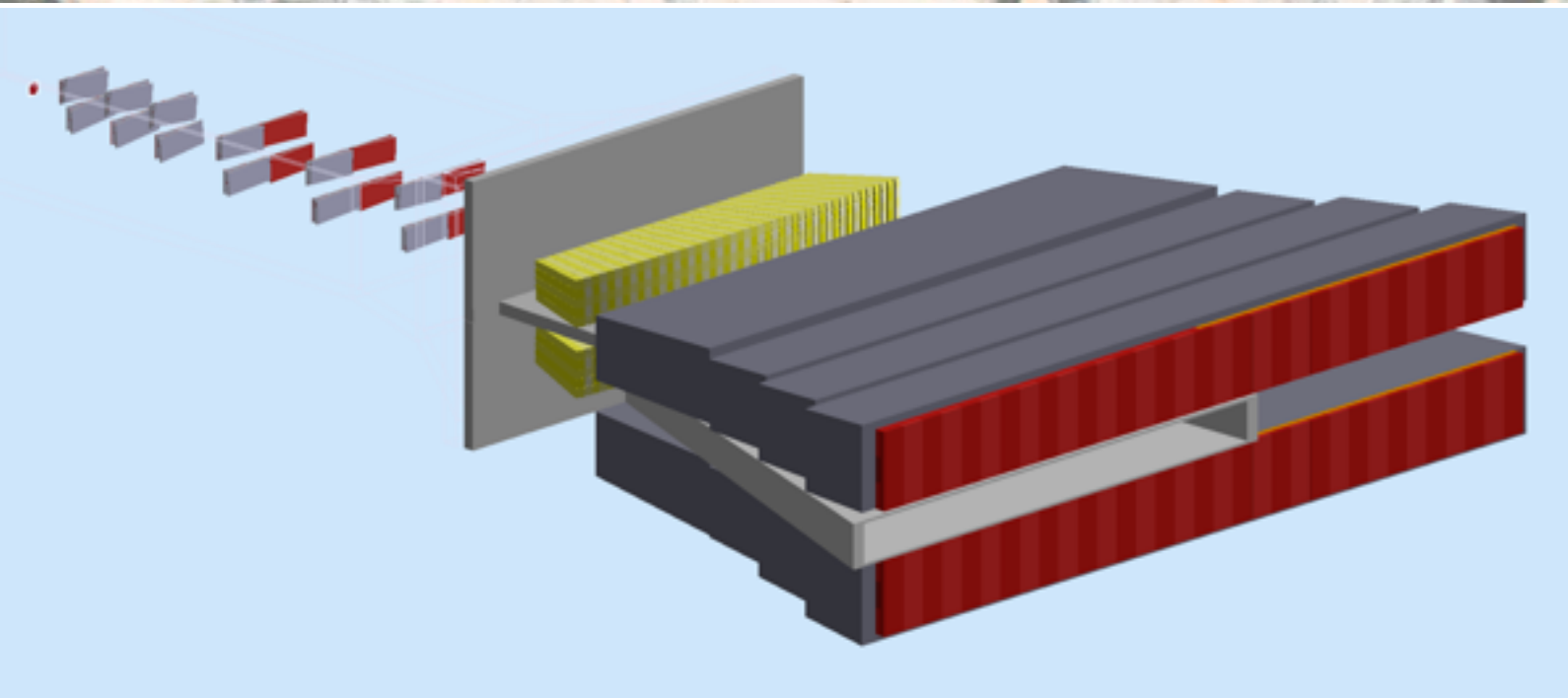

Add a segmented muon detector behind ECAL for muon trigger.  
Adds a second channel to look for high mass  $A'$  decays.

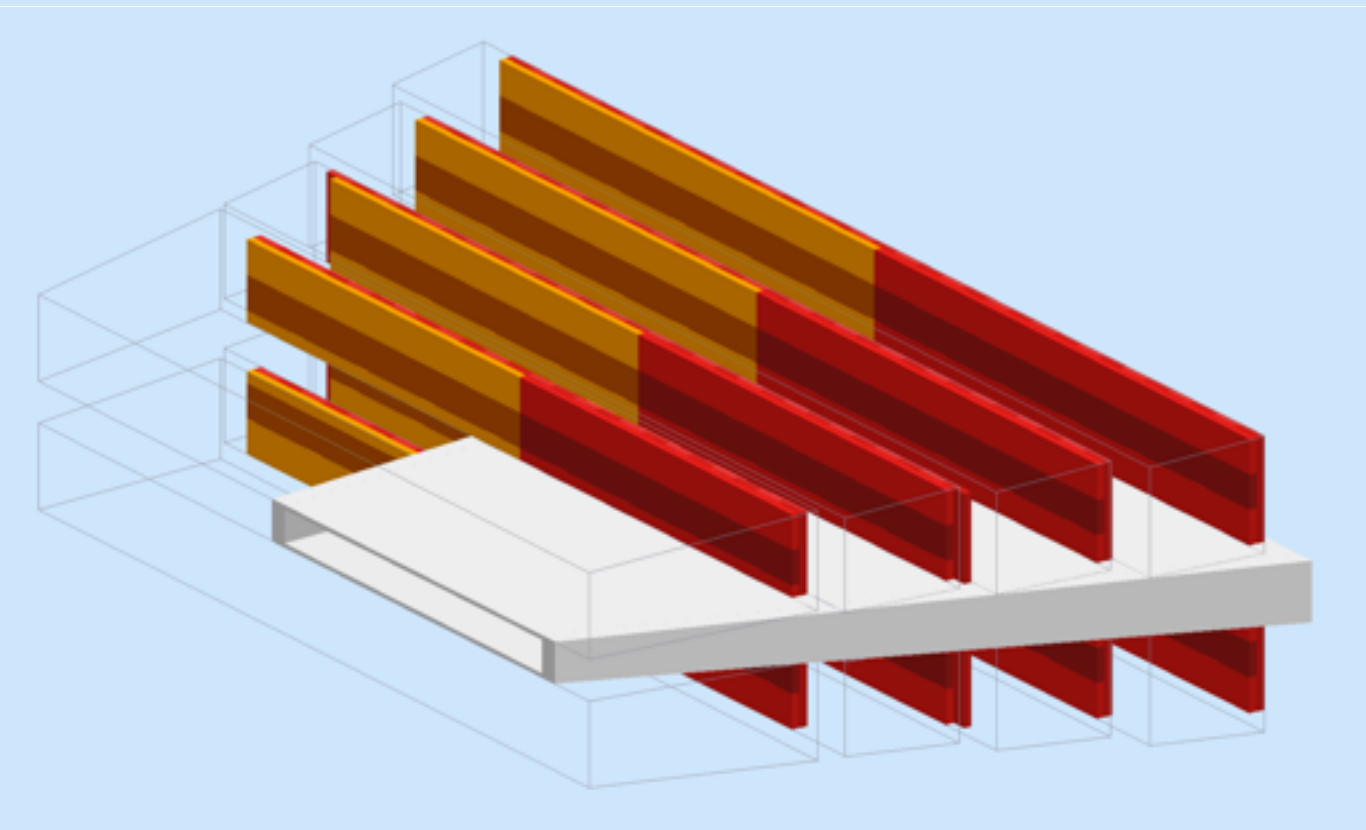

$\gamma_d$  Branching Ratio

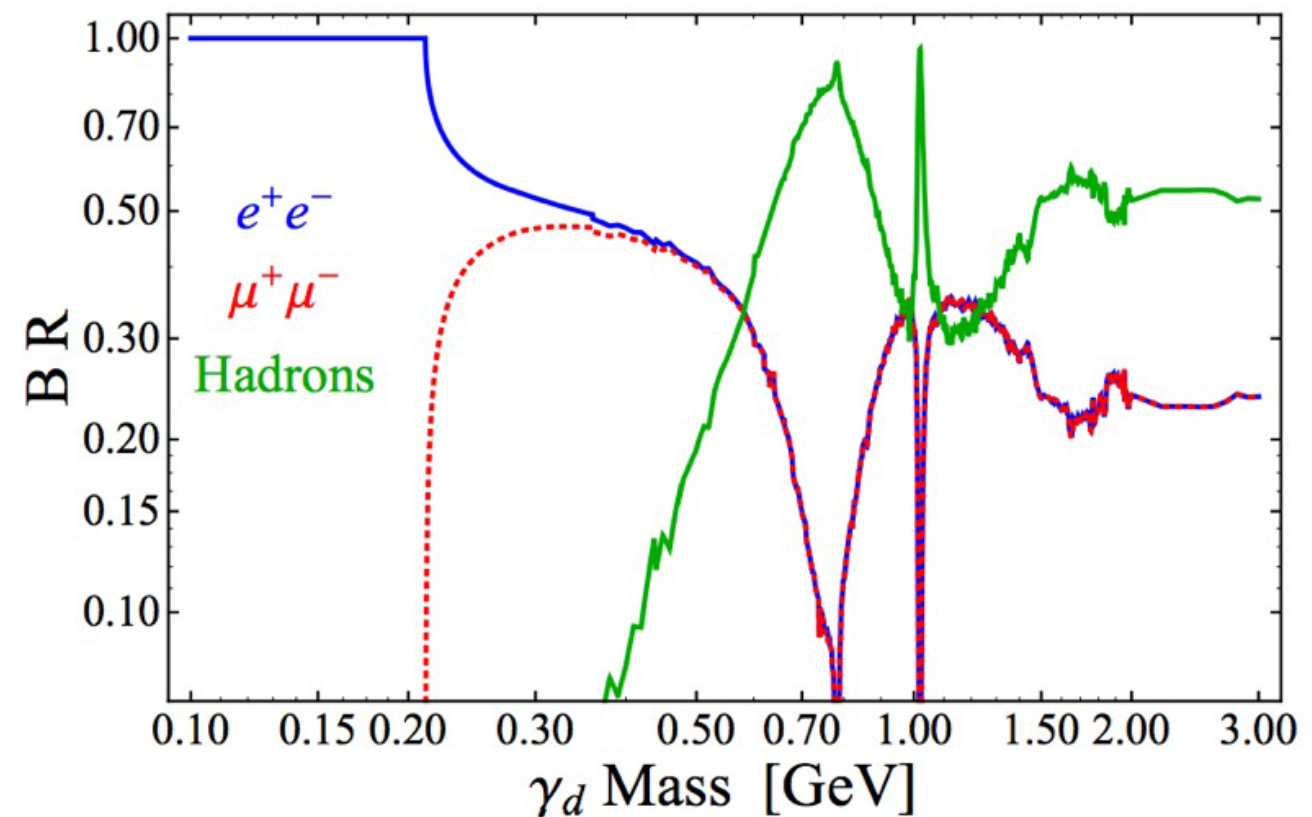

# High Rate DAQ

- **SVT DAQ uses SLAC ATCA-based architecture**
  - Sensor hybrids pipeline data at 40 MHz and send trigger-selected data to COB for digitization, thresholds, and formatting. COB transfers formatted data to JLAB DAQ.
  - Record data up to 50 kHz in pipeline mode.
- **Ecal DAQ and Trigger**
  - Data recorded in 250 MHz JLAB FADC. Pulse height and time transferred every 8ns to Trigger Processors FPGA.
  - Trigger sent to SVT DAQ and FADC for data transfer.
  - Ecal FADC and DAQ can trigger and record data up to 50 kHz.

Cluster on Board (COB)



Ecal DAQ/Trigger

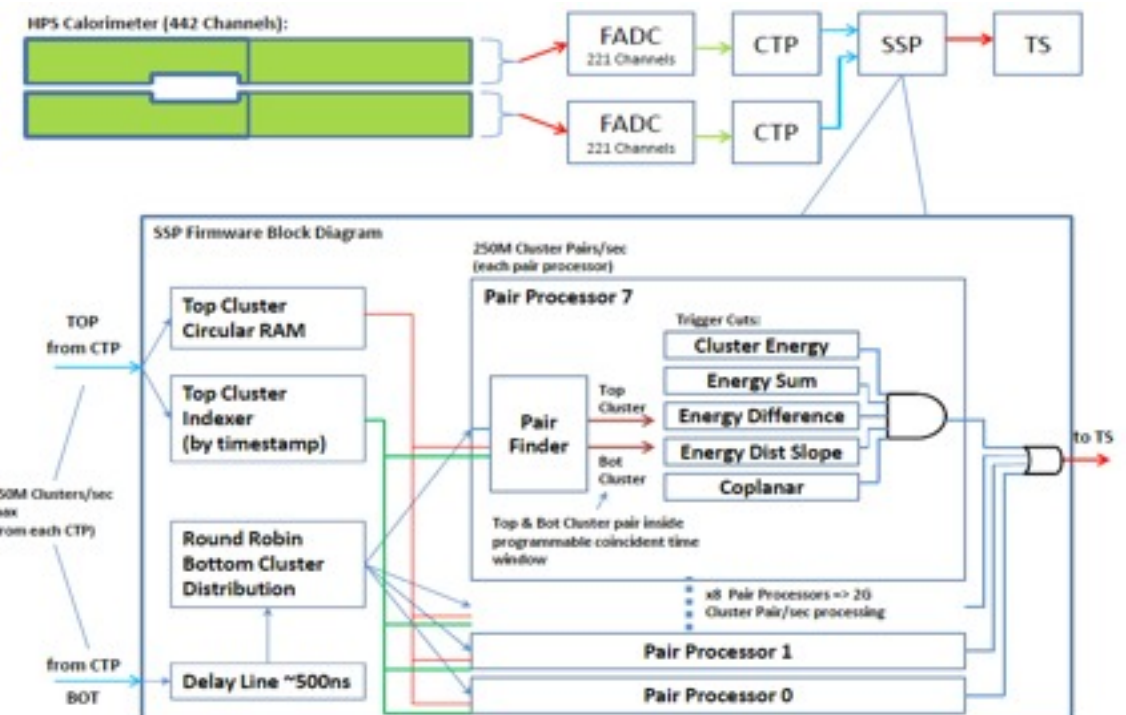

**Data rates up to 50 kHz**



# HPS Test Run 2012

- The HPS Test Run, **designed to demonstrate the experiment's technical feasibility.** Installed and run at JLAB during Spring 2012.
- Commissioned parasitically with a photon beam.
- The last 8 hours of CEBAF-6 of dedicated photon beam time.
- Test for tracker capabilities.
- Test of the trigger with a fast EM Calorimeter .

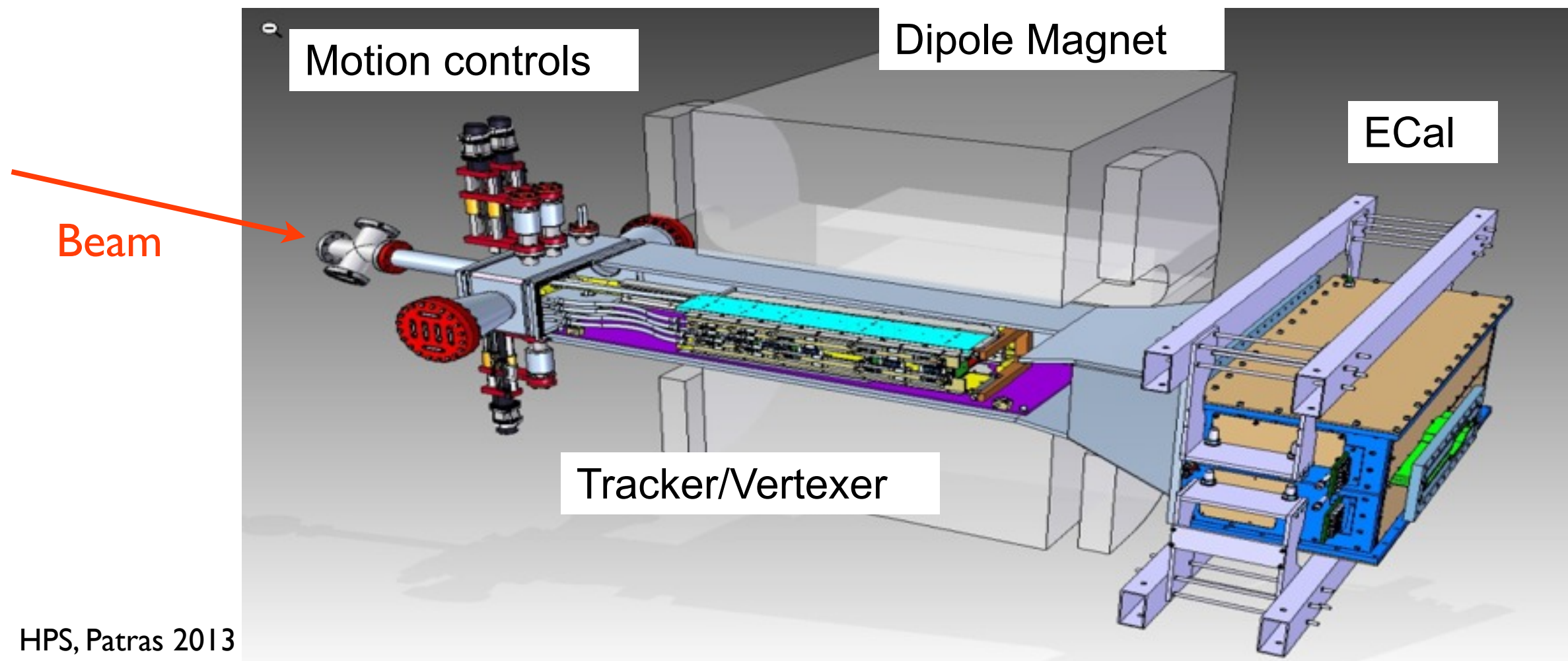

# Measured SVT Performance

Elevation

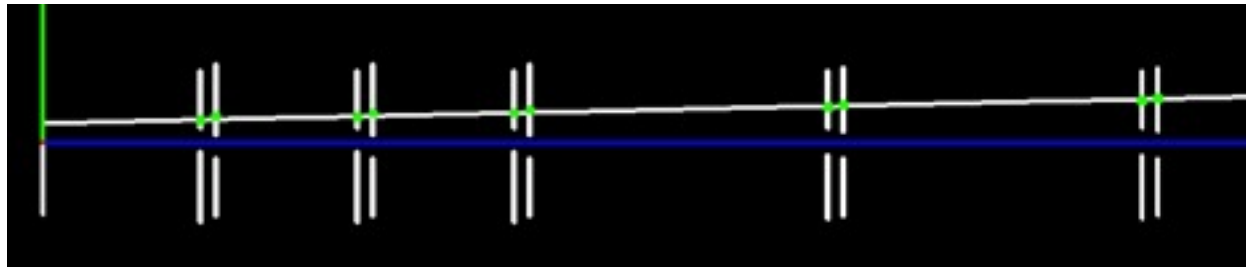

Bend Plane

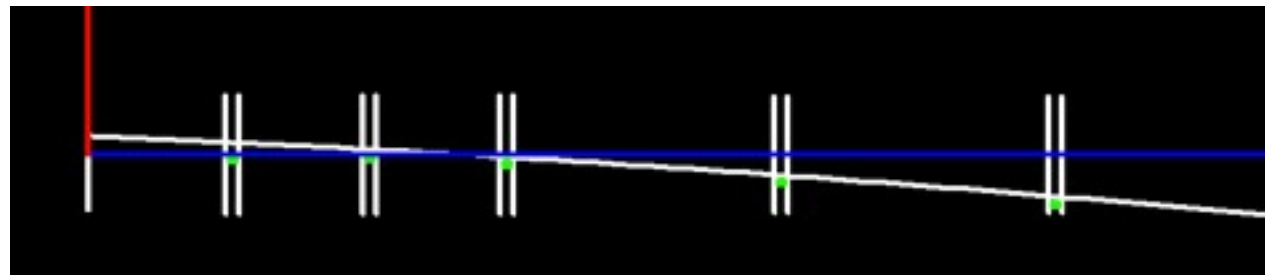

MIP Cluster PH ~ 1600 ADC counts

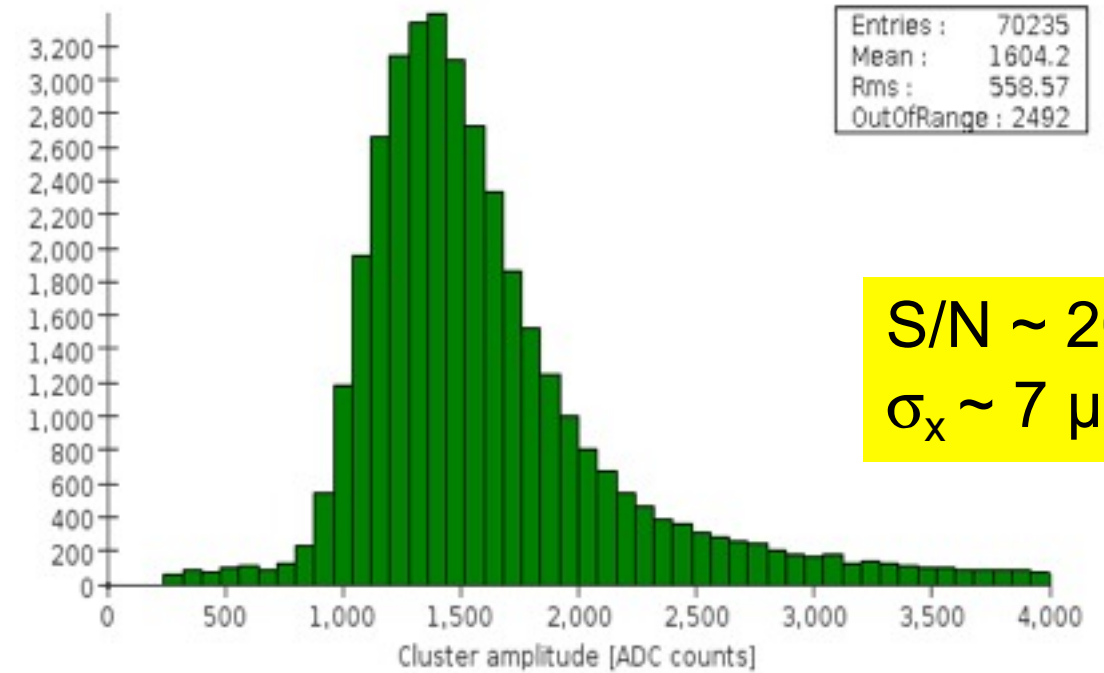

S/N ~ 20  
 $\sigma_x \sim 7 \mu\text{m}$

Record pulse shape in 6-25ns bins  
 $\Rightarrow$  track time

Track Time Resolution

$\sigma_t \sim 3 \text{ ns}$

APV25 pulse shape, channel 17, positive pulses

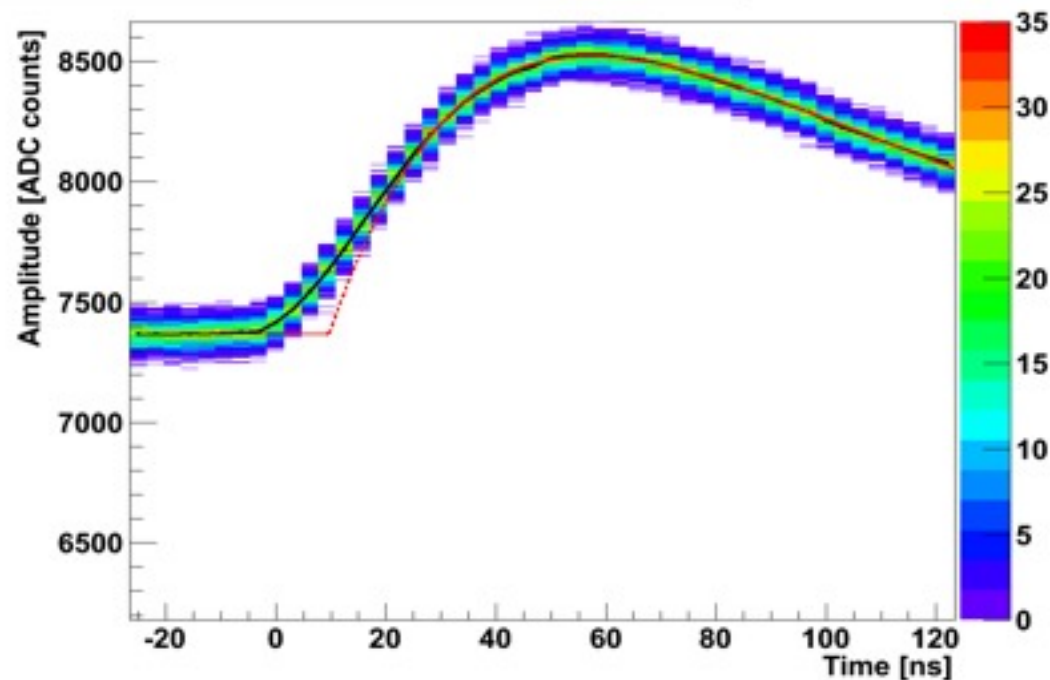

Tracker TestRunModule layer1 module0 sen...

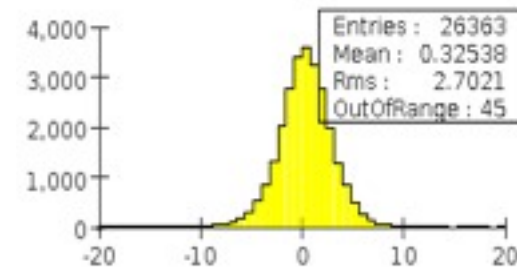

Tracker TestRunModule layer2 module0 sen...

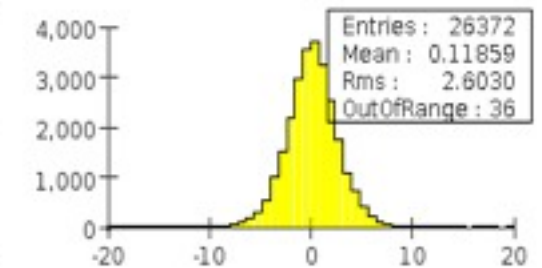

Tracker TestRunModule layer3 module0 sen...

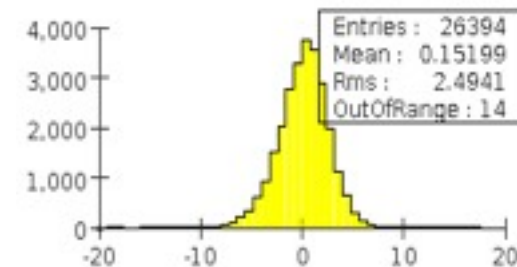

Tracker TestRunModule layer4 module0 sen...

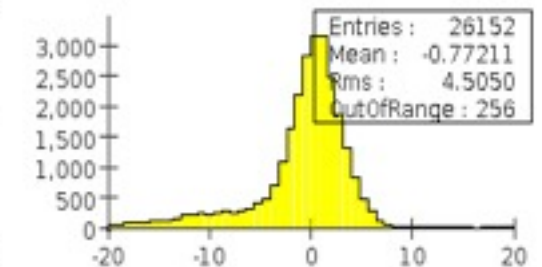



# Measured ECAL performance

Color shows average crystal PH over Face of ECAL

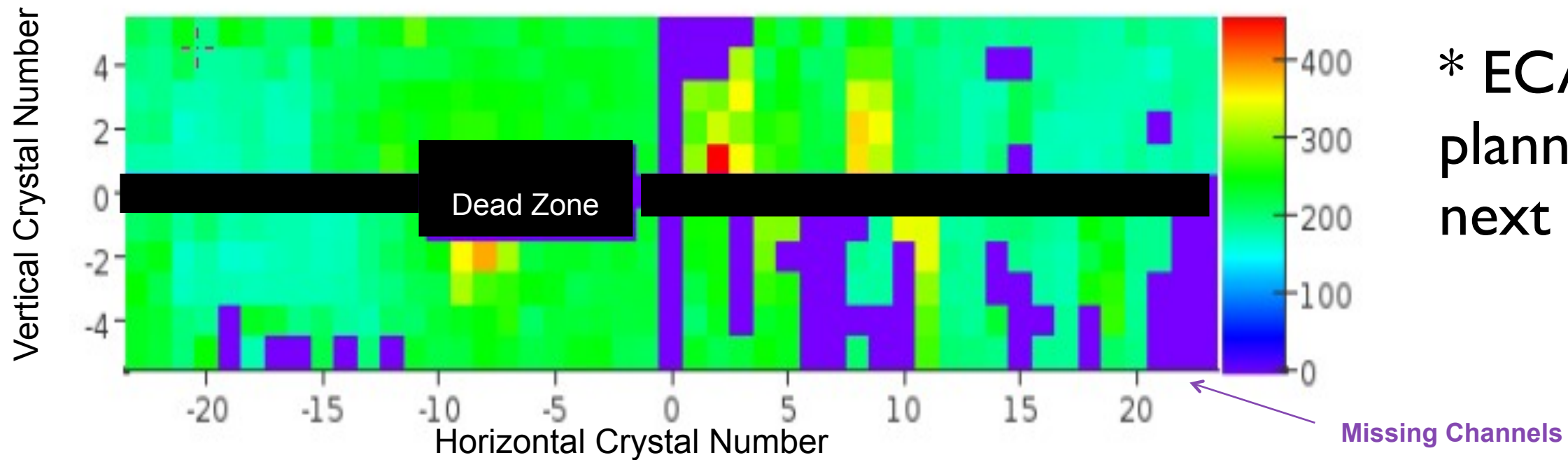

\* ECAL upgrade planned before next running.

## Cluster Size for tracks with $p > 0.6$ GeV/c

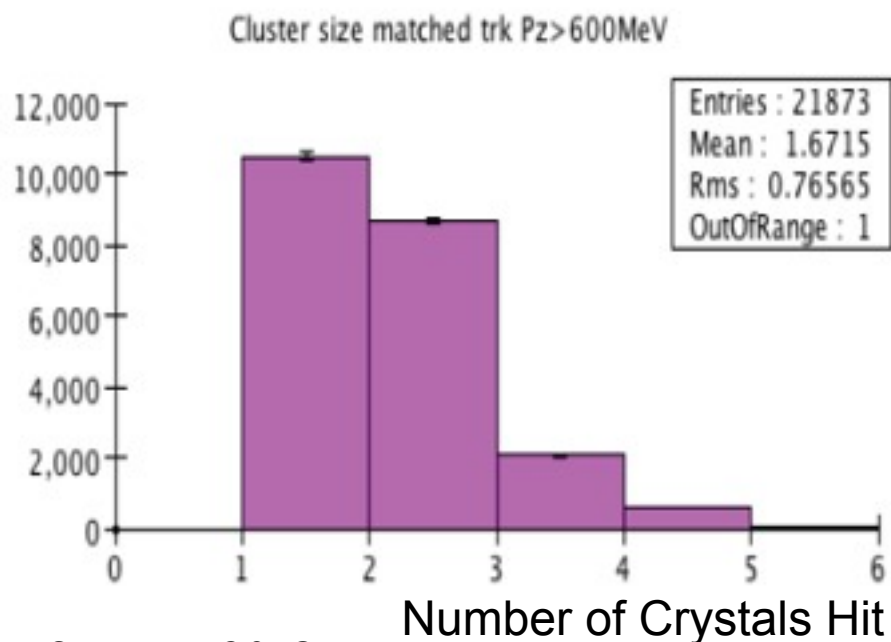

## Cluster Energy Data/MC

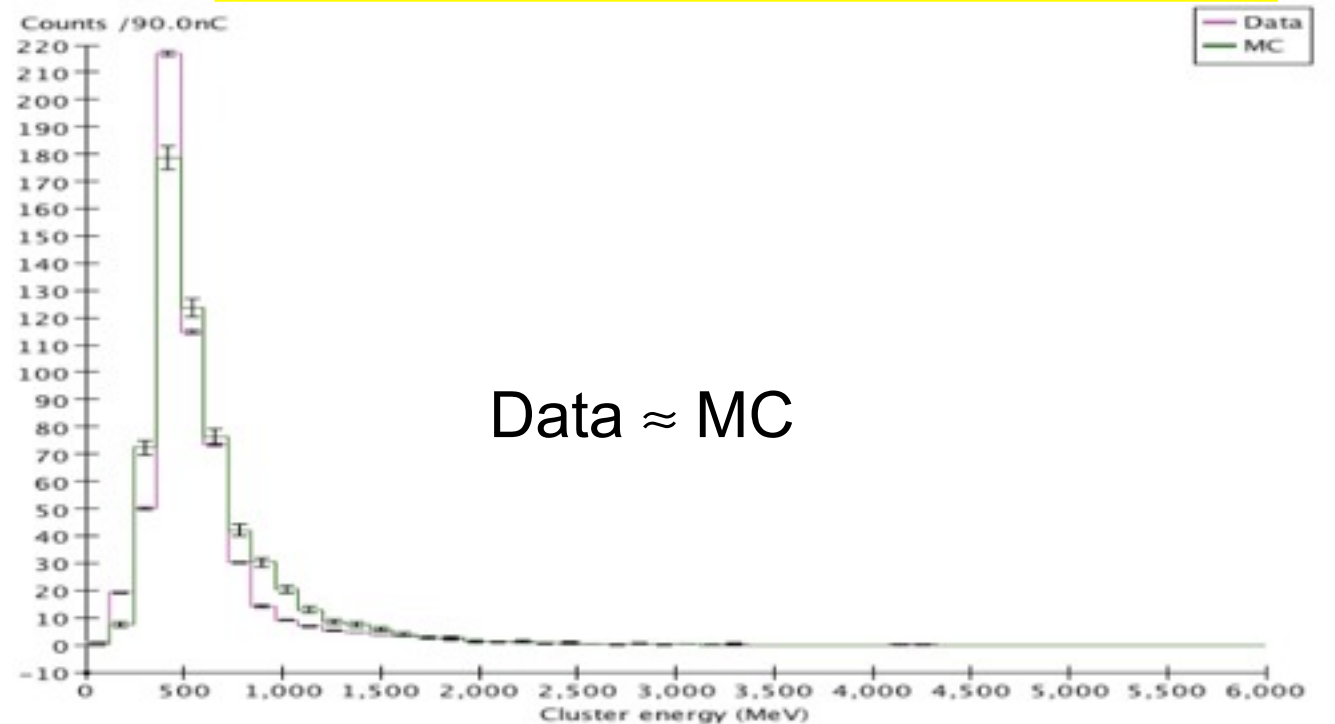

# Reach

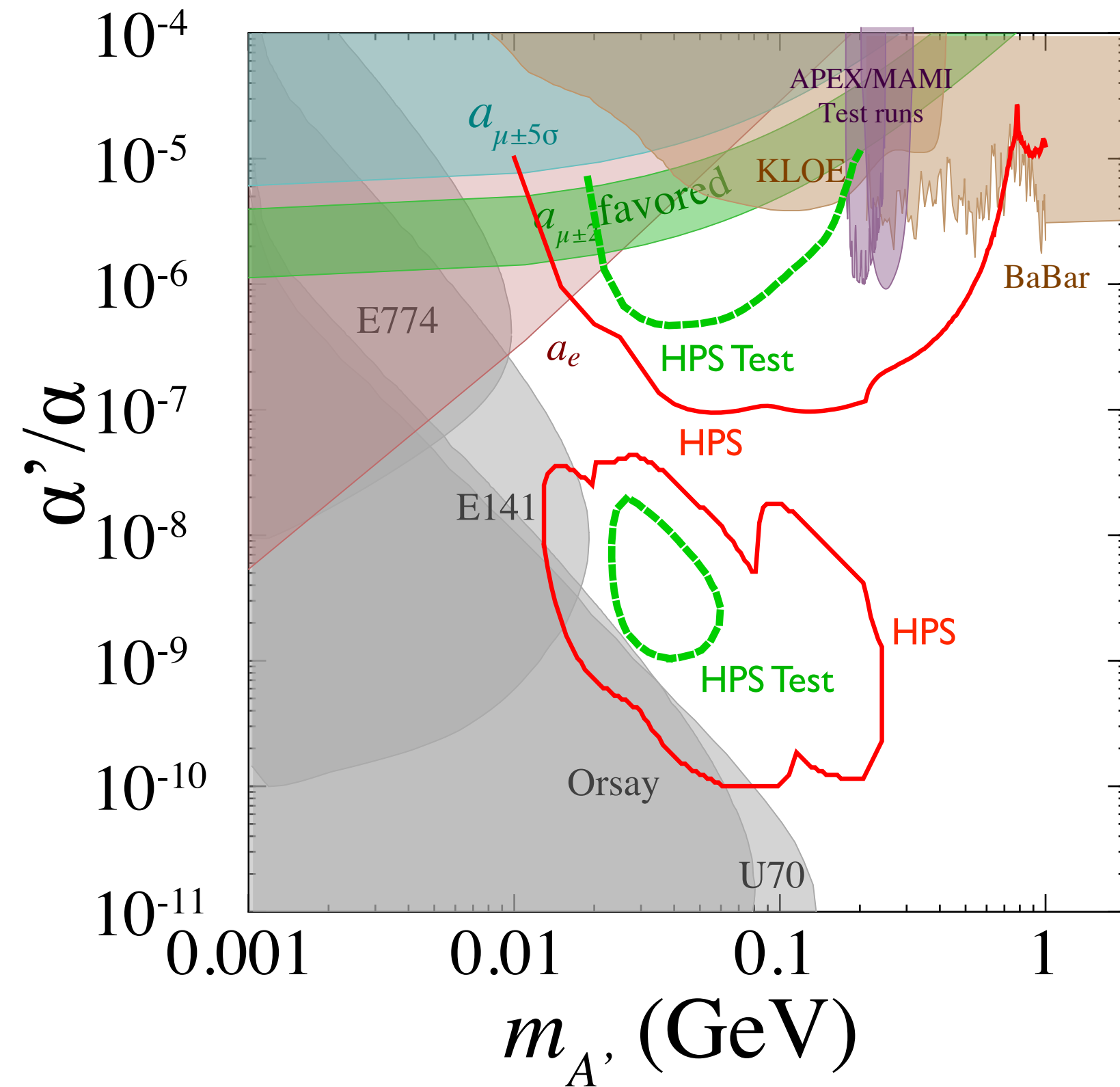

**Green dashed:**  
2.2 GeV, 200 nA  
0.125%  $X_0$  target  
~1 week of  
commissioning  
data in 2014.

**Red line:**  
2.2 GeV, 200 nA  
6.6 GeV, 450 nA  
180 days of data,  
starting in 2015



# All Jlab approved experiments.

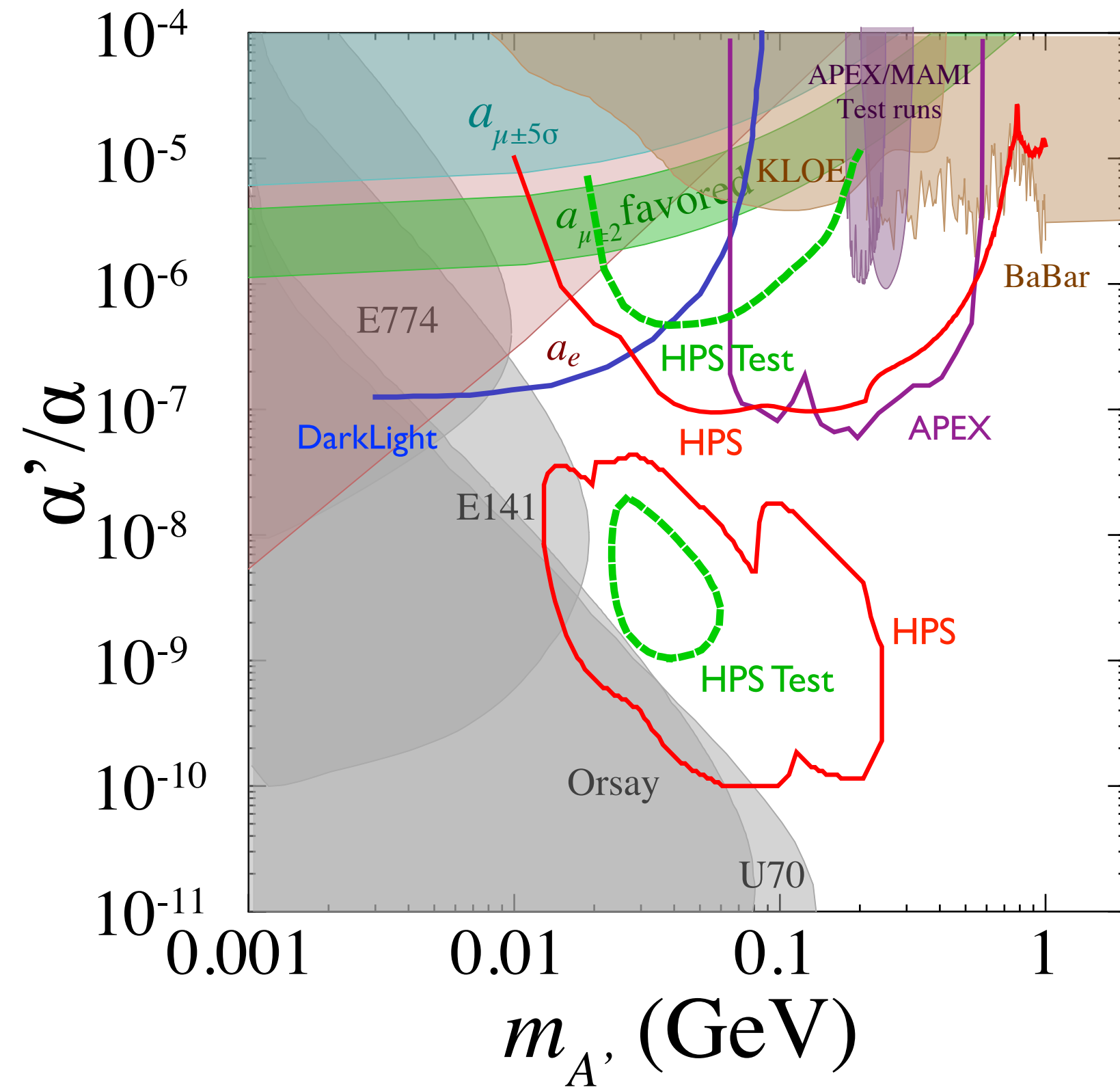

**APEX** - Jlab Hall-A  
Using spectrometers.

**HPS** - Jlab Hall-B  
New dedicated detector.

**DarkLight** - Jlab FEL  
Using internal "active"  
target recoil detector.

Not shown:  
Vepp3, Mainz, Babar, BELLE,  
KLOE, BES, SuperB, D0, Atlas,  
CMS,...



# Conclusions

- \* The Heavy Photon Search and APEX are two ambitious experiments at Jlab, looking for the  $A'$ , a heavy  $U(1)$  vector boson.
- \* Challenging experiments.
- \* Both have excellent reach & discovery potential.
- \* Experiments are being upgraded for 2014/15 run.

SVT Module assembly



HPS, Patras 2013

SVT cosmic tests



Vacuum system

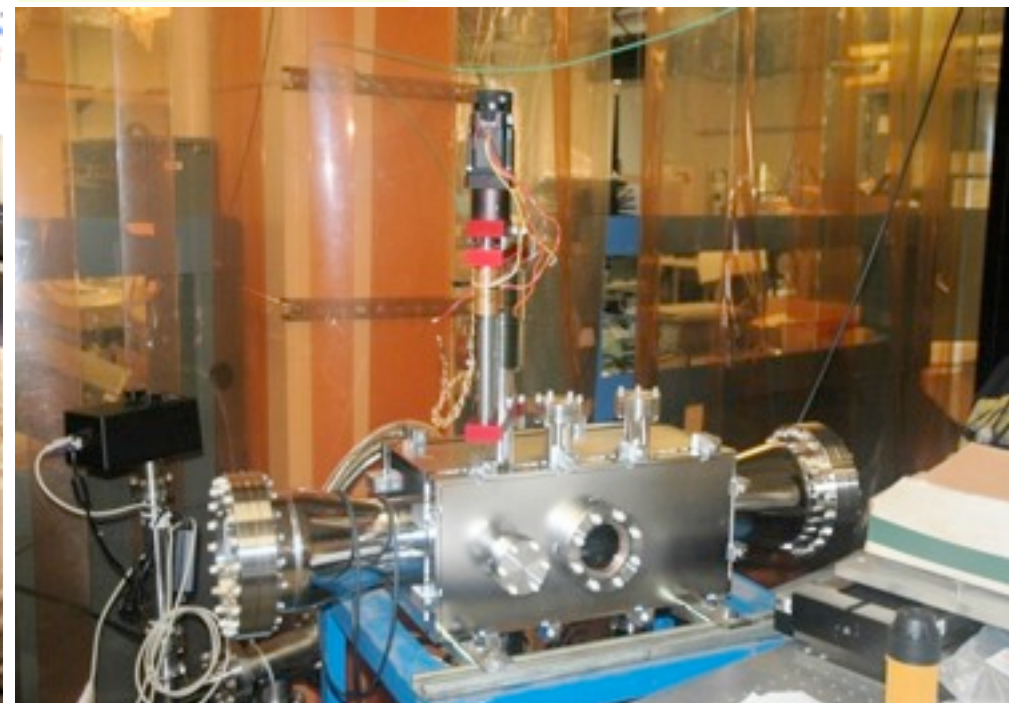

Tracker module





The image features a background of marbled paper with a complex, organic pattern of dark grey, black, and light beige or cream colors. The pattern resembles natural stone or biological tissue. A semi-transparent dark grey rectangle is centered horizontally and vertically, serving as a backdrop for the text.

**Extras**



# Is HPS ready for electron beams?

- **Full Monte Carlo simulation shows MCS of beam electrons is the principal HPS background**

The tails of the multiple Coulomb scattering of beam electrons in the target hit the innermost layers of the tracker and Ecal and are the principal cause of tracker occupancy and ECal trigger rate.

- **EGS5 simulations accurately describe MCS tails from thin targets.**  
They agree with formal MCS Theory (Moliere, and Goudsmit-Saunderson) and available thin target data. (Not true for GEANT4!)

$$\frac{d\sigma}{d\Omega} \approx F(\theta) 2\pi d(\cos\theta)$$

Moliere integral vs. EGS5

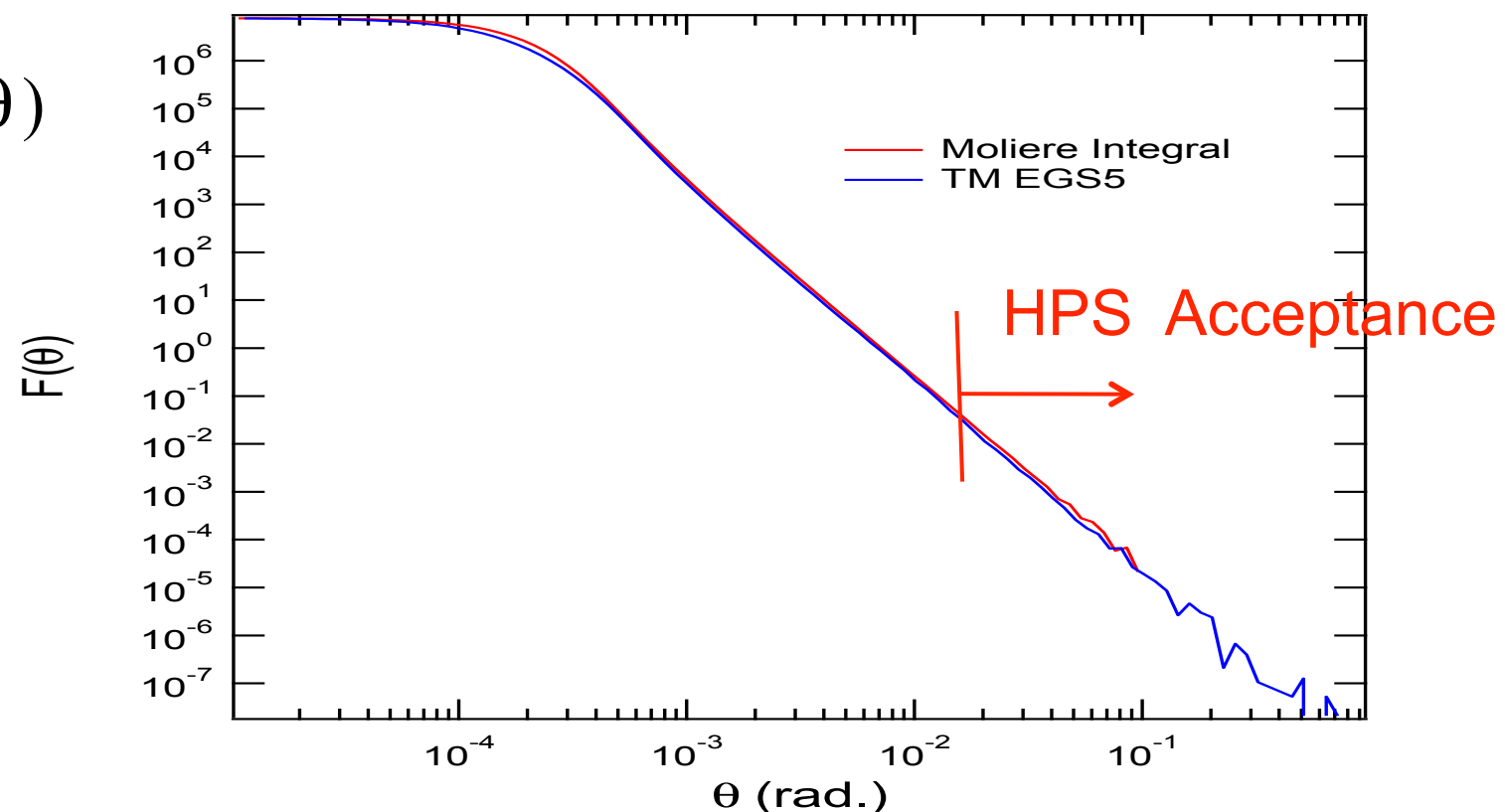



# YES, HPS is ready!

- Photon conversions in the test run produce pairs whose angular distribution depends on two effects, of roughly equal importance:
  - 1) pair opening angle distribution
  - 2) Multiple Coulomb Scattering of electrons through the target

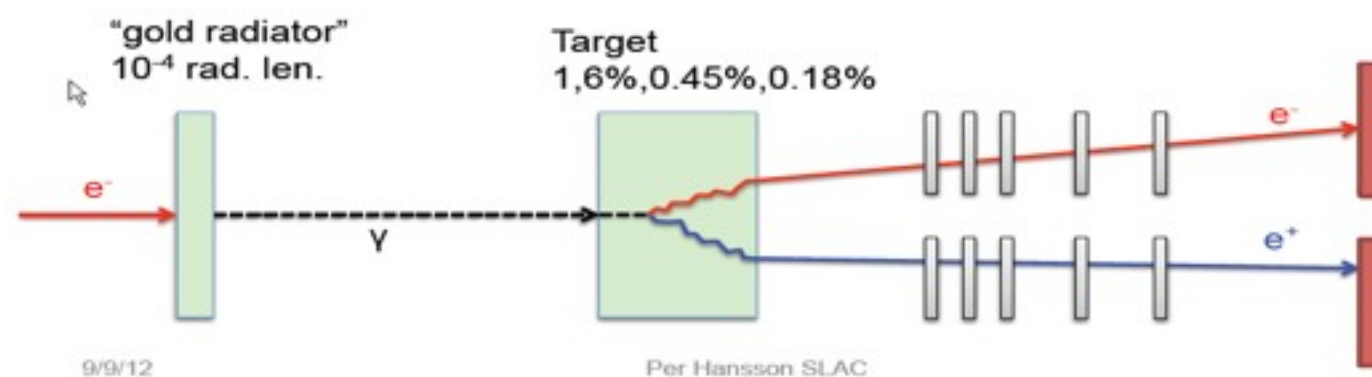

- With a photon beam incident, the HPS trigger rate is almost entirely due to pair production in the target. The observed rate is given by the pair angular distribution, integrated over the Ecal acceptance.

Trigger Rate Data agrees with EGS5 simulation.

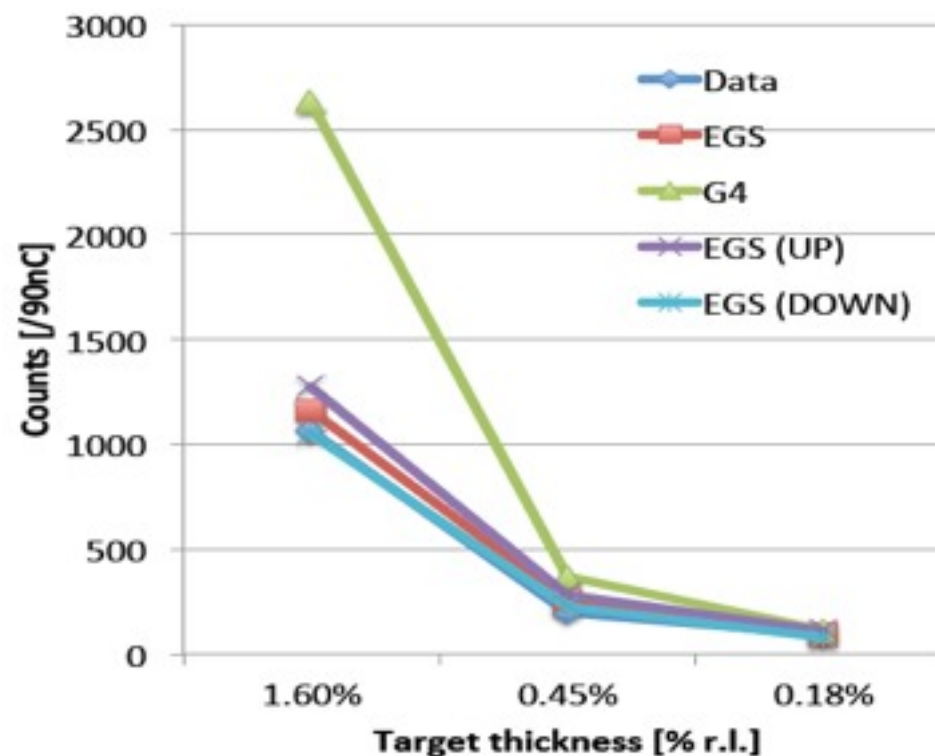

Background estimates using the EGS5 simulation are reliable.

HPS ready for e- beams

# True Muonium, $\mu^+\mu^-$ atom

- TM produced in target, easily dissociates, but some survive
- Long lived bound state (10 keV binding energy) decays to  $e^+e^-$
- $M = 2 m_\mu$ ,  $\gamma c\tau = 35$  mm at 6 GeV
- Looks like an  $A'$ , but known rate and lifetime.

Estimated production from Philip Shuster

- Assume 6 GeV, 450 nA, 0.1% X0 target
- 1 month run
- Raw yield (IS): 180 events for  $x > 0.8$ ,  $\lambda > 1.5$  cm
- Estimated acceptance  $\sim 20\%$



25 detected events, with very little background =  
Discovery!

Decay Length Distribution

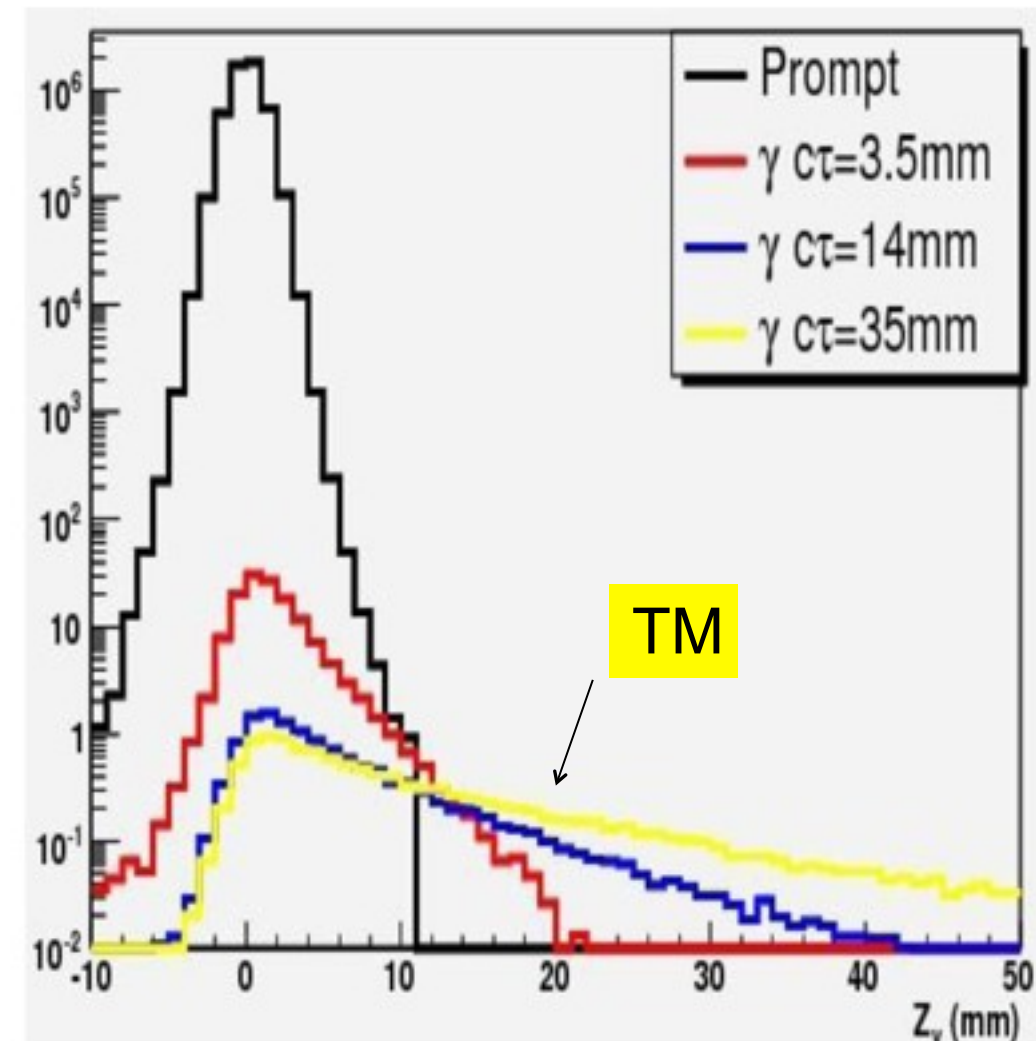



# How to search? $M_{A'} > 1 \text{ MeV}$

Wherever there is a photon there is a dark photon...

## Collider

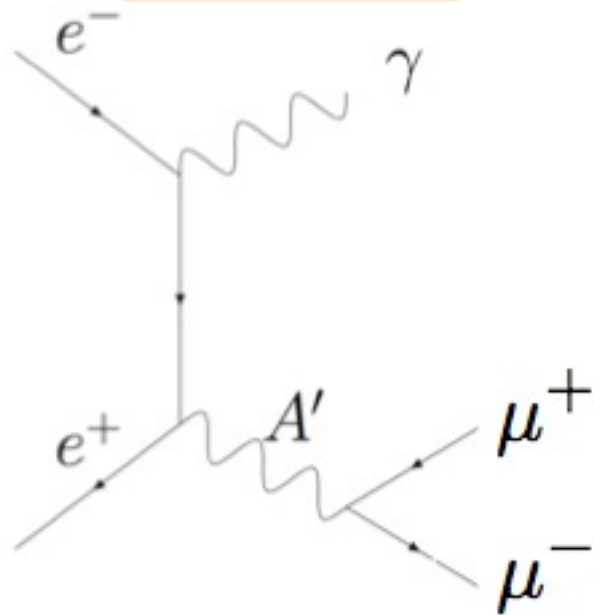

$$\sigma \sim \frac{\alpha^2 \epsilon^2}{E^2} \sim O(10 \text{ fb})$$

~~$O \text{ ab}^{-1}$  per decade~~

month

## Fixed Target

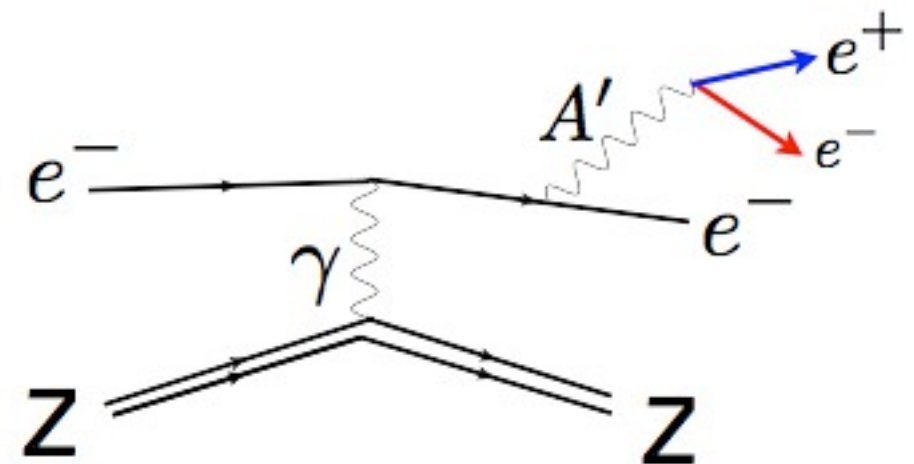

$$\sigma \sim \frac{\alpha^3 Z^2 \epsilon^2}{m^2} \sim O(10 \text{ pb})$$

$O \text{ ab}^{-1}$  per day

...but much higher backgrounds

**BEST:** Bjorken, Essig, Schuster, Toro, *Phys.Rev. D80* (2009) 075018

# HPS Timeline

- 2009 - Idea of experiment comes from Bjorken, Essig, Shuster, Toro
- **January 2011** - PAC27 approved a test run to demonstrate technical feasibility of the experiment.
- **June 2011 - Funding from DOE HEP for Test Run: ~\$1M approved**
- April 2012 - Test run apparatus ready for beam
- April 2012 - Scheduling conflicts in Hall B prevented HPS Test Run getting a dedicated electron run.
- May 2012- **HPS Test runs parasitically** with another experiment using a photon beam.
- **May 2012 - Dedicated photon running, with a thin conversion target** in front of HPS, **during the last 8 hours of CEBAF-6** let us fully commission the detector and DAQ and prove its technical feasibility.
- These data let us make the case that HPS Test performs as advertised, and that *the backgrounds expected in electron running are understood.*
- **June 2012 - PAC approves experiment, with A rating, 180 days of beam.**  
(But we still need to test the electron beam running)
- 2012 - Redesign Test Run silicon tracker to withstand long high current running.
- June 2013 - Jlab commits to HPS commissioning run for Fall 2014, possible data run in 2015.
- July 2013 - Presentations to DOE HEP for new funding to build HPS. Request: \$1.8M